

JANUARY
2026

CLAYTON
Dustless Made Simple™



INDUSTRIAL & AEROSPACE SOURCE CAPTURE SPECIALISTS

Phone 732-363-2100 | www.JClayton.com | www.DustlessMadeSimple.com

Table of Contents

Introduction



Welcome to Clayton	1
Ordering Information.....	3

Vacuum Systems.....4



The Scorpion Handheld HEPA Vacuums.....	5
Piranha Spot Blaster, Air Hammer Kit.....	7
FOD POD & FOD POD C-130 Vacuum.....	8
Hornet Ultra Portable HEPA Vacuums.....	9
Stingray EXP Vacuums.....	13
Backpack.....	15
Python HEPA Vacuums.....	16
WartHog HEPA Vacuums.....	22
WartHog G2 HEPA Vacuums.....	36
Barracuda Immersion Separator.....	53
DustMaster ULPA Vacuums.....	57
Hippo Drum Pump.....	69
HEPA Grinding Station.....	70
Tent & Vent.....	71
Mobile Paint Booth.....	73
Heli-Cell.....	74

Sanders.....76



ErgoLite Sanders.....	78
AeroLite Sanders.....	86
AeroLite Two-Hand Sanders.....	94
DuraLite Sanders.....	98
ElectroLite Sanders.....	106
Specialty Sanders.....	109
Hand Sanding Blocks.....	111

Sander Parts & Accessories.....114



Backup Pads.....	115
Pad Protectors, Interface Pads.....	122
Repair Parts.....	124
Drop-In Motors.....	125
Sander Rebuild & Repair.....	126

Universal Shrouds & Shrouded Tools.....128



Right Angle Sander Shrouds.....	129
Cartridge Roll Shroud.....	133
Seat Track Cleaning Shroud.....	134
Edge Finishing & Deburring Shroud.....	135
Universal Cutoff Saw Shrouds.....	136
Universal Radial Shrouds.....	137
Drum Sander Shrouds.....	138
Piloted Bonding Brush Shrouds - One Piece Metal Brush.....	139
Piloted Bonding Abrasive Shrouds - 4 Piece System.....	140
Universal Drill Shroud.....	143
Right Angle Drill Shroud.....	144
Flexible FOD Wands.....	145
Precision Drills.....	146
Soft Drill Shrouds.....	147
Drill Guides.....	148
The Microstop Countersink Shroud Kit & Individual Shrouds.....	149
Belt Sander Shroud.....	150
Dreamliner Repair Kit.....	153
Router Shroud.....	155
Inline Router.....	156
Pencil Grinder Kit.....	157
Burrs.....	158

Rotary Shrouds for Hook & Loop Abrasives.....	159
Shrouds for Flap Wheels and Buffing Wheels.....	160
Rivet Shaver Shroud.....	161

Abrasives.....162



All About Abrasives.....	163
DustMaster Supreme Screen Abrasive.....	164
DustMaster Coarse & Silicon Carbide.....	165
DustMaster Gold Abrasive.....	167
Understanding Quick Change Disc Abrasives and Backup Pads.....	168
Quick Change Resin Bond Discs/ Non Woven Discs.....	169
Quick Change Surface Prep Kits.....	171
Quick Change Assortment Packs.....	172
3M Scotch-Brite Bristle Discs.....	173
Cut Off Wheels.....	174

Hoses & Fittings.....176



Compressed Air & Vacuum Hoses.....	177
Vacuum Hose by the Foot.....	179
Adapter Hoses.....	180
Hose Cap Assemblies, Hose Holders.....	182
Torque Reducing Right Angle Extension, Sleeves & Y's.....	183
Hose Cuffs, Hose Connectors.....	184
Compressed Air Line.....	185
Fittings, Couplers, Plugs, Ball Valves.....	187
Distribution Modules.....	189
Clayton 4 Port Distribution Rover.....	190
AutoGate Air Tool Activated Gate Valve.....	191
Hose Support Belt.....	192
Clean Up Tools.....	193
Magnetic Quick Disconnect for Tools & Hoses.....	199

Filters.....200



Filters 101.....	201
HEPA Filters, Pre-Filters, Bag Filters.....	203
Timer Cards.....	204

Cleaning Products & Field Repair.....206



Hygenall HexOff.....	207
----------------------	-----

Brake Washers.....212



Brake Washers & Parts Washers.....	213
Comparison/ROI.....	214
Mini Brake Washer.....	215
Economy Brake Washer.....	216
Deluxe Brake Washer.....	217
Truck Brake Washer.....	218

Mobile/Portable Tool Storage.....220



Tactical Box, Storage Cart.....	221
Rhino Mobile Work Center.....	223
Twin Tech Mobile Workcenter.....	225
Twin Tech Vacuum Mounted Workcenter.....	227

Measurements and Conversions.....230

Conversions.....	231
Exposure Limits.....	235

Welcome to Clayton

Protecting Workers for over 30 Years

Clayton Associates was established in 1984, and has become an industry leader in hazardous dust control solutions. Starting with Jim Clayton's first vacuum for asbestos removal, the company began a legacy of innovation, constantly improving and enhancing the product line to best meet the needs of workers in automotive, aerospace, and industrial applications.

Today, Clayton engineers employ rapid prototyping and on-site testing to produce customized solutions for some of the most technologically advanced aircraft the world has ever seen. Clayton is best known for the ability to design solutions to solve specific dust control problems for our aerospace customers. From sanders designed for trouble areas of the F-22 Raptor, to custom piped systems that help commercial airlines move more planes through their paint hangars, Clayton solutions are engineered to solve our customers' problems and increase productivity.

We strive to provide new and innovative solutions by listening to our customers needs and employing rapid concept to market practices.

How We Work

The Clayton Team manages a fleet of demonstration vehicles across the country. We meet with our customers at their facilities, to fully understand the needs of the workers. The procedures employed to fabricate or maintain an F-22 Raptor or a C-17 GlobeMaster will likely differ greatly from those used on a Boeing 737 or Apache Longbow. We need to understand those differences if we're going to be able to provide the right solution. We put the tools and equipment into the hands of the workers, to ensure that they are in support of the solution. We need to capture the dust, but we also need to satisfy the user. As an Air Force customer once remarked: "If the workers don't like using the tools, they just won't use them."

Arrange a Demonstration

Call or email Clayton today to arrange a demonstration of our equipment, and to learn more about how we can help your organization to reduce worker and environmental exposure to hazardous dust.

Sales@JClayton.com
800-248-8650

  
Jim Clayton Brad Clayton Jan Clayton



Corporate Headquarters • 1650 Oak St, Lakewood, NJ 08701

Trademark & Copyright

Trademarks and service marks used in this catalog are the property of their respective owners. Use of these marks without the prior written consent of their owners is strictly prohibited.

Dotco® is a registered trademark of Cooper Tools.

Dynabrade is a registered trademark of Dynabrade, Inc.

Pelican® is a registered trademark of Pelican Products, Inc.

DustMaster™, Dustless Made Simple™, Universal Shroud™, Hornet™, Super Hornet™, Safe Filter Change™, Ultra Portable Pneumatic HEPA Vac™, Wart Hog Vacuum™, TNT™ are trademarks of Clayton Associates, Inc. 3M™, Cubitron™, Hookit™, Scotch-Brite™, Greptile™, and Roloc™ are trademarks of 3M.

Lexan® is a registered trademark for SABIC Innovative Plastics.

AirCenter™ is a trademark of Kaeser Compressors, Inc.

HexOff™ is a trademark of Hygenall Corporation.

This catalog is dedicated to the US Armed Forces



A Family Owned and Operated American Manufacturer

Starting with the production of Jim Clayton's first vacuum cleaner design in the early 1980's, Clayton Associates has been family owned and family operated. Through the years, Jim and Jan Clayton's children have been involved in the business and helped it to grow. We have a tremendous team to support our customers, but you can always call our offices and ask to speak with one of the Clayton management team directly to resolve issues or provide feedback. As the business has grown, we have always kept our focus on protecting our customers, and promoting American manufacturing. Clayton currently has its primary manufacturing facility in Lakewood, New Jersey, and keeps almost 100% of our raw materials and fabricated parts sourced locally to promote domestic job growth and to ensure that the next generation of our family and yours has the opportunity to work in the great United States of America.

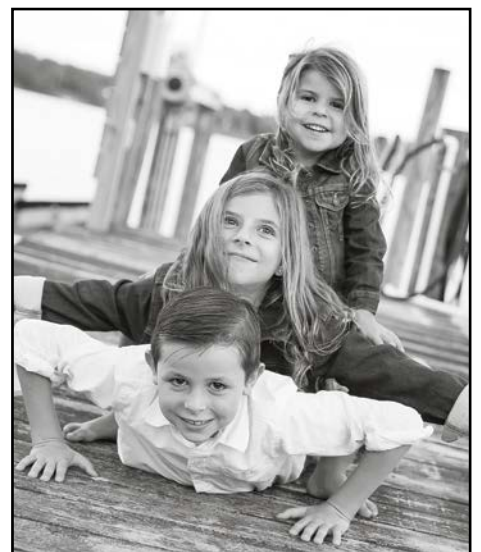

The next generation of Claytons

Ordering Information

Payment

We accept Visa, MasterCard and American Express in addition to Personal and Company Checks. Net 30 day accounts are available for orders over \$500 for customers with acceptable credit.



Shipping

Orders are shipped UPS ground unless otherwise requested. Orders which exceed UPS weights or measures are shipped common carrier. We welcome international orders.

Returns

Any defective product may be returned freight prepaid to Clayton Associates and will be repaired or replaced, assuming it has not been altered, abused, or misused in any manner.

Returns cannot be made based on suitability or lack thereof for an intended use. It is the users responsibility to determine product suitability for their intended use, and assume all risk and liability in connection with its use.

Trademarks

All trademarks used in this catalog are the property of their respective owners and their use does not imply approval or endorsement of Clayton Associates by the trademark owner.

Customer Service

We appreciate your business! If you ever have a problem with any Clayton product, please contact us so that we may address the problem immediately. You can reach us during our normal working hours via our 800 number or 24 hours per day via email.

Hours

Our US sales and customer service departments are open from 8 – 5 Eastern Time (GMT-5)

Demonstrations

In addition to the product demonstration videos on our website, in-person demonstrations are conducted on a regular basis and available upon request. We suggest that demonstrations be held at customer's facilities to adequately evaluate our products in your specific environment.

Pricing

Prices are subject to change without notice. Please contact us to confirm pricing when placing an order.

Information Accuracy

In our constant commitment to product improvement & customer satisfaction, equipment features and specifications may change over time. Please check to be sure you have the latest version of our catalog. The most current of our catalog is always available for download from our website.

Government Orders

For US government orders, many of our products have National/NATO Stock Numbers (NSN). Our complete list of NSNs can be found at the back of the catalog.

Many items are also available on the GSA Advantage website.

Our GSA Contract No. is GS07F-228BA and our Cage Code is 0C1P4.



VACUUM SYSTEMS

Hornet Portable Vacuum • Warthog HEPA Vacuum • Electric & Pneumatic Vacuums and Accessories



THE SCORPION

HANDHELD HEPA VACUUM



The Scorpion HEPA Vacuum is an industry first. The Scorpion is a pneumatic vacuum that is so small and light it can be carried by hand or worn over the shoulder. Its powerful air motor easily picks up dust and debris, and helps maintainers control FOD while also protecting them from exposure to heavy metals like cadmium, hexavalent chromium, lead, and more. The Scorpion can be used for cleanup after manufacturing and maintenance, or it can be paired with a shrouded tool to control dust and debris while sanding, grinding, cutting, or drilling.

The Scorpion features a tough Lexan canister which showcases the cyclonic action of the vacuum. You'll get hours of enjoyment watching rivets, dust, and metal shavings spinning around the belly of the Scorpion. The HEPA cartridge filter provides the right level of protection, exhausting clean air back into the workplace. For vacuum sanding or shrouded tools, the Scorpion features pass through compressed air, so you'll only need one air line to power the vacuum and the tool.

Features:

- Recovery capacity 1qt
- HEPA filter efficiency H13 99.97@ 0.3 mu
- Consumes 15 cfm @ 90 psi
- Produces 45 cfm @50 "H₂O
- Quiet at only 77dBA
- Lexan canister is virtually indestructible
- 7" Diameter by 9" high

Cleanup Kit Includes:

- 4' x 1" Vac Hose
- 24" x 3/4" Tygon FOD Wand
- Prefilter 5 pack



SC-100CK

Vacuum Sanding Kit Includes:

- 4' x 1" Hose whip
- 4' x 1/4" Compressed air line
- Prefilter 5 pack

Air Powered



Military Combo Kit

Everything you need for vacuum sanding and cleanup

- 4' x 1" Vac hose
- 4' x 1/4" Comp air line
- Assorted cleanup tools
- Prefilter 5 pack
- Extra HEPA filter

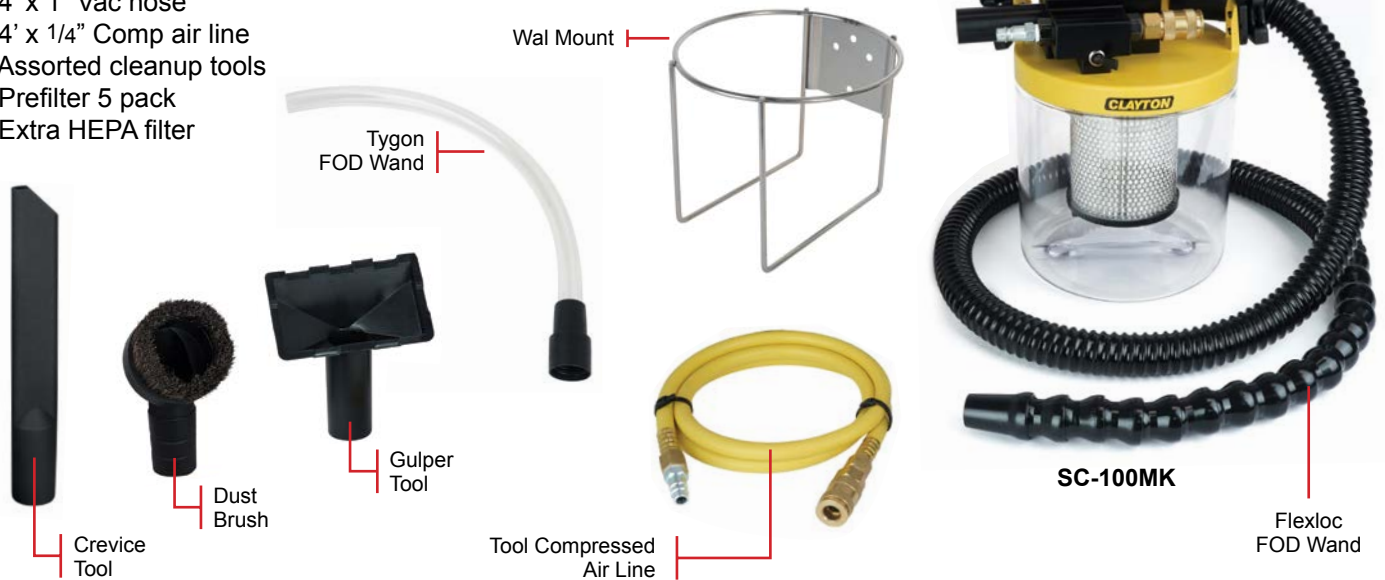

Scorpion

Model	NSN	Desc	Price
SC-100CK		Scorpion Pneumatic HEPA Cleanup Vac Kit	
SC-100TK		Scorpion Pneumatic HEPA Sanding Vac Kit	
SC-100MK	4130-01-507-7013	Scorpion Pneumatic HEPA Military Vac Kit	

Scorpion Consumables

Model	NSN	Desc	Price
627-516H	4460-01-519-5158	HEPA Filter for Hornet / Scorpion	
627-516P		Prefilter Scorpion 5pk	

Scorpion Accessories

Model	NSN	Desc	Price
671-VHA16-022		Adapter Hose 4ft - 1in Hose to 1-1/4in Smooth Cuff	
922-A04H04		Compressed Airline 1/4in x 4ft	
922-A06H30		Compressed Airline 3/8in X 30ft	
500-415-1216	4130-01-478-3108	FOD Wand 3/4in x 1in x 18in (15 element)	
604-005		Scorpion Vac Wall Mount Wire Form	



Piranha Spot Blaster

Our portable pneumatic recirculating Spot Blaster removes corrosion and coatings from fasteners and small areas. You choose your blast media, and this tool does the rest. A pull of the trigger, and the media is safely delivered in a enclosed concentrated blast. The integrated Scorpion HEPA vac collects and recirculates the media.



Includes

- Spot Blaster Gun & Vac
- Shoulder Strap
- 4 Assorted Tips



Piranha Spot Blaster

Model	NSN	Desc	Price
PR-100BK		Piranha Recirculating Spot Blast Basic Kit	

Air Hammer Kit

Air Hammers are great for loosening rusted bolts, cutting sheet metal, and breaking welds. The Clayton Air Hammer kits include vibration damped air hammers with quick release chucks and powerful 22mm bores. The short barrel compact hammer with a 2-1/4in stroke is rated at 3,800 blows/minute for faster more controllable cutting. The long barrel hammer is rated at 2,700 blows/minute with 3-1/2in stroke for jobs requiring more impact force. They are housed in tough protective cases with 5 assorted chisels each.

Includes

- Air Hammer with quick release chuck
- 5 assorted chisels
- Plastic case

Air Hammer Kit

Model	NSN	Desc	Price
690-AH2700LK		Air Hammer Kit 22mm 2700bpm 3.6in stroke	
690-AH3800SK		Air Hammer Kit 22mm 3800bpm 2.2in stroke	



- 3-1/2in stroke
- 2,700 blows/minute



- 2-1/4in stroke
- 3,800 blows/minute



FOD POD

The Clayton FOD Pod is designed to be used with any Clayton electric or air powered vacuums. It intercepts large debris like rivet stems while allowing dust to continue onto the vacuum. The FOD Pod is available in two sizes depending on the amount of debris to be collected. An additional vacuum hose of at least 5ft is required for connection to the vacuum.

FOD Pod

Model	NSN	Description	Price
FP-200-01		FOD Pod Small	
FP-200-02		FOD Pod Large	

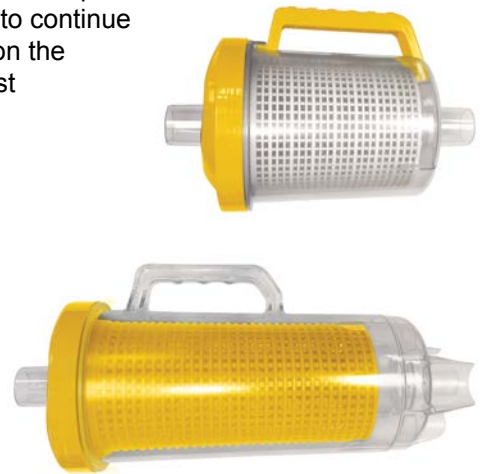

FOD POD C-130 Vacuum System

The Clayton FOD Pod C-130 Kit is designed to be used with the C-130 fuel & oxygen overboard vent port. The vent port is capped with a AN929-16 cap. The FOD Pod C-130 Kit comes with a 1-1/4in rubber hose cuff that will push onto this port when the cap is removed. When the C-130 is pressurized and at altitude the pressure differential between the cabin and outside air act as the vacuum source.

Features:

- 2ft hose for connection to the aircraft
- 2 x 20ft vacuum hoses for a total of 40ft reaches tail and cockpit
- 2 piece wand
- Dust brush & Crevice tool

FOD POD C-130

Model	NSN	Description	Price
FP-100-01		FOD Pod Kit for C130	



HORNET

ULTRA-PORTABLE PNEUMATIC HEPA VACUUM



Hornet ultra-portable pneumatic HEPA vacuum designed specifically for dustless sanding and composites fabrication.

This unit is small enough to carry out to the flightline, but packs more than enough power for corrosion control, surface prep, or general cleanup.

The Hornet is incredibly efficient and powerful enough to use with sanders, grinders, and cutting tools.

The Hornet has been designed for the removal of coatings containing Hexavalent Chromium (Cr VI), lead, cadmium and other heavy metals, aluminum dust, carbon fiber, ceramic dust, fiberglass and mold. These units are extremely portable, lightweight and feature extra heavy duty components that ensure long life and extreme durability for industrial and military environments.

The Hornet pneumatic HEPA Vacuum incorporates Safe Filter Change unique to Clayton.

This means technicians can open the filter compartment and change the primary vacuum filter without protective gear or exposing other workers and environment to hazardous dust.

All this in a package so small, only 6" in diameter, and so portable that it can be used for deployment or mobile maintenance operations. Shops with central vacuum systems or larger mobile vacuums will find new freedom to perform spot repairs in the hangar or on the flight line, without exposing workers or the environment to hazardous dust.



Small footprint at only
20" x 6" x 6.5" x 10 lbs
(51cm x 15cm x 16cm x 4.5kg)



II 3 D T85° C

Features:

- ATEX certified for use in Combustible Dust Atmospheres
- Recovery capacity 1 quart (1 liter)
- Vacuum and accessories are electrically bonded to ensure conductivity during use
- HEPA filter: Efficiency of 99.97% @ 0.3 μm (H13)
- Consumes 30-75 CFM @ 90 PSI (user adjustable)
- Includes 1/2" compressed airline with 1/2" industrial interchange fittings
- Quiet at only 77dBA
- Innovative cooling wand, keeps users cool and comfortable while working with the vacuum
- Static conductive air/vacuum hose with sheathing
- Ergonomic backpack harness (not shown) with chest clasp allows vacuum to be securely worn on back
- Tool Control - Shadow-boxed two-color foam for FOD control / prevention
- Rugged Construction - Packaged in an indestructible, lockable, wheeled Pelican Case
- Turn-key Operation upon receipt

Air Powered

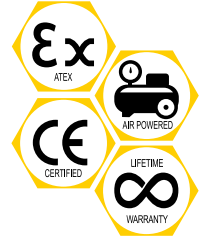

User adjustable from 70" to 170" static water lift, and 65 to 85 CFM airflow

Corrosion resistant, aluminum construction



Mil-spec grounding jack allows users to ground vacuum or bond it to an aircraft using a standard flight line grounding cable

Vacuum and sander operate from a single 1/2" compressed air supply line



Differential Pressure Gauge



Compressed air for sander or tool

Self closing vacuum inlet

Non-marring static conductive rubber rails provide static dissipation

Built in compressed air gauge shows system pressure



Compressed Air Line
Conductive / All Stainless Steel Fittings

Hornet Consumables

Model	NSN	Description	Price
627-516H	4460-01-519-5158	HEPA filter	
690-A0031	4460-01-519-5125	Bag Filter 10 pack	
92X-A08H30-II	4720-01-663-1575	Airline 1/2" x 30' Conductive	
67X-AVHW1616-08	4720-01-663-1580	Air/Vac Work Hose 8' Conductive	
900-A001-30	6150-01-671-8172	Aircraft grounding wire 30'	
500-415-1216	4130-01-478-3108	FOD Wand 3/4" x 1" x 18"	
600-114DM	8105-01-521-2119	Black poly bag 25 pack	
500-4017		Wall Mount Bracket	



HEPA Filter



FOD Wand



Wall Mount Bracket



Air/Vac Work Hose
Conductive / All Brass Fittings



Filter Bags



Grounding Cable

HORNET

ULTRA-PORTABLE PNEUMATIC HEPA VACUUM



The Hornet vacuum is available alone or in 4 package configurations.

Hornet Packages	ACE-1000	ACE-500	ACE-400	ACE-300	500-400
NSN	^				
Hornet Vacuum	✓	✓	✓	✓	✓
Pelican Case	✓	✓	✓	✓	
FOD Wand	✓	✓	✓	✓	
30' x 1/2" Air Supply Line	✓	✓	✓	✓	
Vacuum Hose				✓	
Air / Vacuum Hose	✓	✓	✓		
Bag Filters 10 pak	✓	✓	✓	✓	
Backpack Harness	✓	✓	✓	✓	
Aircraft Grounding Cable	✓	✓	✓	✓	
3" Random Orbital Sander	✓				
5" Random Orbital Sander		✓			
6" Random Orbital Sander	✓				
Backup Pads 1 each	✓				
Pad Protectors 100 discs	✓				
180 grit abrasive 500 discs	✓				
240 grit abrasive 500 discs	✓				
320 grit abrasive 500 discs	✓				

^ See www.NSNCatalog.com for details

ACE-1000

Turn-key Dustless Sanding System includes Clayton random orbital sanders with abrasives, backup pads, and protector pads for each.

ACE-500

Complete Dustless Sanding System includes 5" Clayton random orbital sander.

ACE-400

Basic Dustless Sanding System. Customer supplies sander or purchases a Clayton sander separately.

ACE-300

Cleanup Vacuum, great for FOD pickup.

500-400

Hornet vacuum only. All hoses and accessories sold separately.

Hornet Ultra Portable HEPA Vac

Model	NSN	Price
500-400		
ACE-300		
ACE-400		
ACE-500		
ACE-1000	7910-01-390-5761	

Use our Hornet Wall Bracket to mount hornets in decontamination or transition areas for personal cleanup. Vacuum slides in and out from the top and gravity holds it in place.



Wall Mount Bracket



STINGRAY

HAZLOC HEPA VAC



Air Powered For Combustible Dust Atmospheres



Designed for use in potentially explosive dust atmospheres, and for the removal of Hexavalent Chromium (Cr VI), paints containing lead or chromates, aluminum dust, carbon fiber, ceramic dust, fiberglass and mold. These units feature extra heavy duty components that ensure long life and extreme durability for industrial and military environments.

The Stingray HazLoc HEPA Vacuum incorporates Safe Filter for the containment of hazardous dust when changing filters.

Features:

- ATEX Certified for Use in Combustible Dust Atmospheres
- All Stainless Steel Non-Sparking Construction
- Machined Aluminum, Adjustable, Peripheral Injection, Annular Venturi
- Grounding Jack and Cable
- Conductive Compressed Air Line
- Self Closing Vacuum Port
- 5 & 15 Gal Capacities
- All components are electrically bonded to ensure conductivity during use
- H14 HEPA filter Efficiency of 99.995% @ 0.3 micron

Ex II 3 D T85° C



STINGRAY

HAZLOC HEPA VAC



Air Powered
For Combustible Dust Atmospheres



Stingray Exp Vacs

Model	NSN	Tank Capacity gal (liters)	Consumption	CFM (lpm)	Vacuum "H2O (mbar)	dBA	Weight lbs (kg)	Price
STX-305T-4		5 ()	60 CFM @ 90 PSI (1699 lpm @ 621kPa)	105 (2973)	180 (447)	67		
STX-315T-4		15 (57)						
STP-305T-4		5 ()						
STP-315T-4		15 (57)						

Stingray EXP Accessories

Model	NSN	Description	Price
627-12HX		HEPA Filter Conductive Stingray H14	
627-12P		PreFilter Warthog 3 pk	
627-1414BC		Filter Bag, 5 Gal Conductive, 5 Pk	
627-16BC		Filter Bag, 15 Gal Conductive, 5 Pk	
92X-A08H30-II	4720-01-663-1575	Compressed Air Hose 1/2in x 30ft Exp Fittings	
900-A001-30	6150-01-671-8172	Aircraft Grounding Wire & Plug 30ft	
630-A008		Heavy Duty Cleanup Toolkit Conductive	



Bag Filter



HEPA Filter



Pre-Filter



Compressed Airline



Aircraft Grounding Cable

1-1/2" Cleanup Vac Hoses (Conductive)

Model	NSN	Vac Hose	Air Hose	Length	Price
67X-VHX24-10		1-1/2"	N/A	10'	
67X-VHX24-15		1-1/2"	N/A	15'	
67X-VHX24-20		1-1/2"	N/A	20'	
67X-VHX24-30		1-1/2"	N/A	30'	



1-1/2" Air / Vac Work Hoses (Conductive)

Model	NSN	Vac Hose	Air Line	Length	Price
67X-AVHW2416-10		1-1/2"	3/8"	10'	
67X-AVHW2416-20		1-1/2"	3/8"	20'	
67X-AVHW2416-30		1-1/2"	3/8"	30'	



BACKPACK

Electric Poly Tank

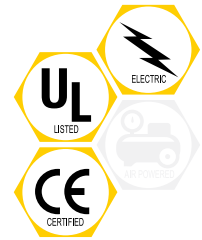

Electric Backpack Vacuum

The HEPA Backpack vacuum takes vacuum sanding and clean up to a new level of ergonomics. Lightweight poly tank and padded backpack harness are supple and supportive, and the powerful industrial motor makes short work of FOD and dust. 2.5 gallon filter capacity minimizes bag changes. Final stage HEPA protects against heavy metal dust exposure. The Backpack vacuum is an excellent choice for FOD cleanup and Vacuum Sanding.

Available with a 400 Hz motor for use on aircraft using power from APU.

Features:

- Ergonomic shoulder straps with chest clasp
- Critical HEPA filter
- Extremely quiet

Includes

- Vacuum Hose
- HEPA filter / Pre-filter
- Cord & Backpack Straps
- Bag filters



Back Pack Vac

Model	NSN	NSN	Price
BP-125-0		Backpack HEPA Vac 2.5 Gal 120V	
BP-125-0-A011	4130-01-501-7033	Backpack HEPA Vac 2.5 Gal 120V FOD Kit	
BP-125-5		Backpack HEPA Vac 2.5 Gal 120V-400Hz Electric	

Back Pack Vac Consumables

Model	NSN	Desc	Price
627-0815B		Bag Filter	
627-0815P		Pre-Filter	
627-0605H		HEPA Filter	



Call 732-363-2100 / 800 248-8650 or Order 24 hours a day from our website @ www.JClayton.com



PYTHON

— CONTINUOUS BAGGING SOLUTION —



CLEAN
SAFE
CONVENIENT
EFFICIENT

Python HEPA vacuums safely capture hazardous dust and debris and prevent exposure during bag changes. They support multiple users for maximum productivity. In operation, solid particulate settles in the base of the canister. Each time the vacuum is turned off, the collected debris falls into the collection bag. The continuous bagging system allows the material inside to be disposed of safely. Simply twist the top of the bag, and secure with two cable ties. Cut between the two ties, and continue operating the system. The design allows bag changes right on the shop floor, without special protective gear. Pythons are available in two sizes to support 1-2 and 2-3 users, and they can be powered by air or electricity. They are great choices for general cleanup or for source capture tools. Get a Python vacuum system today, and protect your workers and your workplace from hazardous dust and FOD.



HOW IT WORKS

Step 1

The bag cassette is sealed at one end with a cable tie. As the bag fills up, simply pull down to draw more material from the cassette.



Step 2

To make a new bag, pull the material down and seal it at the top with a cable tie.



Step 3

Add another cable tie above the first one and cut the bag material off between the two cable ties. The entire process takes less than 30 seconds!

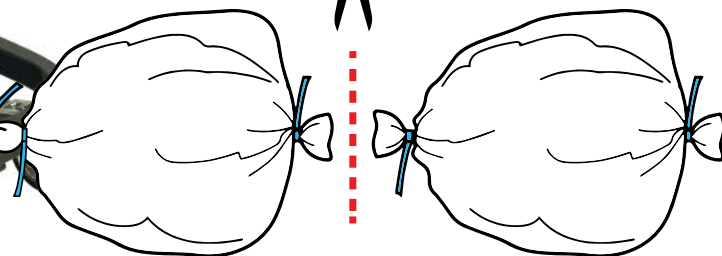

PYTHON

— CONTINUOUS BAGGING SOLUTION —



**Electric
2-3 User**



Python Electric Vacs

Model	NSN	Desc	Price
PV-202-0		Python 120V HEPA Vac CBS (212 cfm @ 98 in/H2O 2in IV)	
627-MN0023L		Longopac Mini Vacuum Bag Refill, 72ft, 4 pack	
684-C0234		Cartridge Filter for PV-202	
684-H0013		HEPA Filter for PV-202	

Accessories

Model	NSN	Desc	Price
684-R5050		Inlet Adapter, 50 x 50	
684-R505050		Inlet Adapter 50 x 50 x 50	

Electric 1-2 User Distribution Kits

Model	NSN	Desc	Price
PV-50Dist1W-0		Python 50mm Dist Kit 1 Way Electric	
PV-50Dist2W-0		Python 50mm Dist Kit 2 Way Electric	

Distribution Kits include compressed air manifold, inlet adapter, and hose cuffs for either 1 or 2 users

Features

- 1 -2 Users
- 2 Motors - 212 cfm
- 120V / 20A
- HEPA filter captures 99.995% 0.3µm and larger



PYTHON

— CONTINUOUS BAGGING SOLUTION —



**Electric
2-3 User**



Python Electric Vacs

Model	NSN	Desc	Price
PV-203-0		Python 120V HEPA Vac CBS (318 cfm @ 98 in/H2O 3in IV)	
627-MN0023L		Longopac Mini Vacuum Bag Refill, 72ft, 4 pack	
684-S0063		Star Filter for PV-203/219/225	
684-H0003		HEPA Filter for PV-203/219/225	

Accessories

Model	NSN	Desc	Price
684-R8050		Inlet Adapter 80 x 50	
684-R805050		Inlet Adapter 80 x 50 x 50	
684-R80505050		Inlet Adapter 80 x 50 x 50 x 50	

Electric 2-3 User Distribution Kits

Model	NSN	Desc	Price
PV-80Dist2W-0		Python 80mm Dist Kit 2 Way Electric	
PV-80Dist3W-0		Python 80mm Dist Kit 3 Way Electric	

Distribution Kits include compressed air manifold, inlet adapter, and hose cuffs for either 2 or 3 users

Features

- 2 -3 Users
- 3 Motors - 318 cfm
- 120V / 20A
- HEPA filter captures 99.995% 0.3µm and larger



PYTHON

— CONTINUOUS BAGGING SOLUTION —



Air Powered 1-2 User

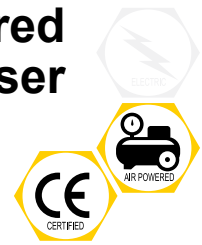

PV-202-4

Model	NSN	Desc	Price
PV-202-4		Python Air HEPA Vac CBS (168 cfm @ 165 in/H2O)	
627-MN0023L		Longopac Mini Vacuum Bag Refill, 72ft, 4 pack	
684-C0234		Cartridge Filter for PV-202	
684-H0013		HEPA Filter for PV-202	

Accessories

Model	NSN	Desc	Price
684-R5050		Inlet Adapter, 50 x 50	
684-R505050		Inlet Adapter 50 x 50 x 50	

Pneumatic 1-2 User Distribution Kits

Model	NSN	Desc	Price
PV-50Dist1W-4		Python 50mm Dist Kit 1 Way Pneumatic	
PV-50Dist2W-4		Python 50mm Dist Kit 2 Way Pneumatic	

Distribution Kits include compressed air manifold, inlet adapter, and hose cuffs for either 1 or 2 users

Features

- 1 -2 Users
- 168 cfm & 165 in/H2O
- Consumes 60cfm @ 90psi
- HEPA filter captures 99.995% 0.3µm and larger



PYTHON

— CONTINUOUS BAGGING SOLUTION —



**Air Powered
2-3 User**

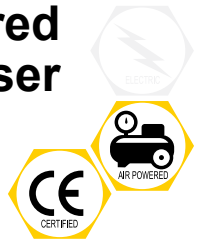

PV-219-4 & PV-225-4a

Model	NSN	Desc	Price
PV-219-4		Python Air HEPA Vac CBS (273 cfm @ 197 in/H2O)	
PV-225-4		Python Air HEPA Vac CBS (347 cfm @ 197 in/H2O)	
627-MN0023L		Longopac Mini Vacuum Bag Refill, 72ft, 4 pack	
684-S0063		Star Filter for PV-203/219/225	
684-H0003		HEPA Filter for PV-203/219/225	

Accessories

Model	NSN	Desc	Price
684-R8050		Inlet Adapter 80 x 50	
684-R805050		Inlet Adapter 80 x 50 x 50	
684-R80505050		Inlet Adapter 80 x 50 x 50 x 50	

Pneumatic 2-3 User Distribution Kits

Model	NSN	Desc	Price
PV-80Dist2W-4		Python 80mm Dist Kit 2 Way Pneumatic	
PV-80Dist3W-4		Python 80mm Dist Kit 3 Way Pneumatic	

Distribution Kits include compressed air manifold, inlet adapter, and hose cuffs for either 2 or 3 users

PV-219-4 Features

- 2 -3 Users
- 273 cfm & 197 in/H2O
- Consumes 50cfm @ 90psi
- HEPA filter captures 99.995% 0.3µm and larger

PV-225-4 Features

- 2 -3 Users
- 347 cfm & 197 in/H2O
- Consumes 60cfm @ 90psi
- HEPA filter captures 99.995% 0.3µm and larger



TWIN TECH

VACUUM MOUNTED WORKCENTER

A cool place for your sanders to hang out at break time.

Features

- Mounts to 15 gallon poly tank
- Storage for two sanders & two 30ft hoses
- Pegboard with hooks and bins
- Two work surfaces
- Paper towel holder
- Replaces existing vacuum handle

SEE STORAGE SECTION FOR MORE DETAILS





WARTHOG

Industrial & Aerospace HEPA Vacuums

Cleanup

- Industrial HEPA Vac
- Electric or Pneumatic
- Poly or Steel Tank

- Designed for general cleanup and house keeping where absolute HEPA filtration is required.

Aero

- Aerospace HEPA Vac
- Electric or Pneumatic
- Poly or Steel Tank
- Safe Filter Change
- Grounded / Bonded
- Filter Health Gauge
- Pass Thru Compressed Air

- Designed for use in environments where toxic dust and static buildup are an issue.

Wet-Dry

- Industrial HEPA Vac
- Electric or Pneumatic
- Poly Tank
- Wet fill auto shutoff

- Designed for general cleanup, house keeping and wet pickup with HEPA filtration.

CLEANUP

WARTHOG



Electric Poly & Steel Tanks

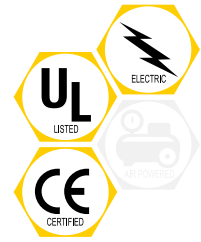

• **WartHog HEPA Cleanup Vacs** are an ideal solution for dust extraction and general cleanup. They provide the airflow, filtration, and durability expected from an industrial vacuum, and are designed for the removal of coatings containing Hexavalent Chromium (Cr VI), lead, cadmium and other heavy metals, carbon fiber, ceramic dust, fiberglass, mold, and asbestos. These units feature extra heavy duty components that ensure long life and extreme durability for industrial and military environments. Components are modular and field serviceable for easy replacement after years of service.

• **Electric Power Heads** feature a heavy duty 2hp 2 stage peripheral bypass 11A motor.

Features

- Self closing vacuum port
- Screw on H14 HEPA filter captures 99.995% of particles 0.3 μ m and larger
- 5, 15, or 30 Gal Capacities

Includes

- HEPA filter / Pre-filter
- Cord & Hose Straps
- Bag filter 5 pak



CLEANUP

WARTHOG



Electric Poly & Steel Tanks

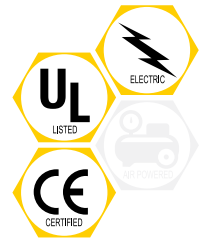

Vacuums al la carte - Choose your own hose and tools.

- **Poly Tanks** are light weight and won't dent, crack, or rust, providing g years of worry free performance in harsh or wet environments.

WartHog Cleanup Electric Poly

(83 dBA - 2hp)

Model	NSN	Tank Capacity gal (liters)	Consumption	CFM (lpm)	Vacuum "H2O (mbar)	Weight lbs (kg)	Price
WC-105-0		5 (19)	120V 11.4A	105 (2973)	110 (274)	25	
WC-115-0		15 (57)					
WC-105-1		5 (19)	220-240V 11.4A	100 (2832)	105 (261)	25	
WC-115-1		15 (57)					

- **Steel Tanks** and dollies are heavy weight powder coated steel and won't burn or melt.

WartHog Cleanup Electric Steel

(83 dBA - 2hp)

Model	NSN	Tank Capacity gal (liters)	Consumption	CFM (lpm)	Vacuum "H2O (mbar)	Weight lbs (kg)	Price
WC-202-0		2 (7.5)	120VAC 11.4A	105 (2973)	110 (274)		
WC-205-0		5 (19)				25	
WC-215-0		15 (57)				47	
WC-230-0		30 (115)					
WC-202-1		2 (7.5)	220-240V 11.4A	100 (2832)	105 (261)		
WC-205-1		5 (19)				25	
WC-215-1		15 (57)				47	
WC-230-1		30 (115)					



Vacuum Kits

- Order your WarHog with a hose below and save!
- Additional Kits Available at the end of this section!

WartHog Cleanup Electric Kits

Model	NSN	Desc	Price
WC-105-0-A000	4130-01-459-5891	WartHog Cleanup HEPA Vac 5G 120V Poly & Hose	
WC-115-0-A000		WartHog Cleanup HEPA Vac 15G 120V Poly & Hose	
WC-205-0-A000		WartHog Cleanup HEPA Vac 5G 120V Steel & Hose	
WC-215-0-A000		WartHog Cleanup HEPA Vac 15G 120V Steel & Hose	
WC-230-0-A000		WartHog Cleanup HEPA Vac 30G 120V Steel & Hose	



CLEANUP

WARTHOG



Air Powered Poly & Steel Tanks

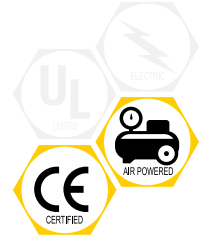

• **WartHog HEPA Cleanup Vacs** are an ideal solution for dust extraction and general cleanup. They provide the airflow, filtration, and durability expected from an industrial vacuum, and are designed for the removal of coatings containing Hexavalent Chromium (Cr VI), lead, cadmium and other heavy metals, carbon fiber, ceramic dust, fiberglass, mold, and asbestos. These units feature extra heavy duty components that ensure long life and extreme durability for industrial and military environments. Components are modular and field serviceable for easy replacement after years of service.

• **Pneumatic (Air) Power Heads** feature a machined aluminum, adjustable, peripheral injection, annular venturi.

Features

- Self closing vacuum port
- Screw on H14 HEPA filter captures 99.995% of particles 0.3µm and larger
- 5 or 15 Gal Capacities

Includes

- HEPA filter / Pre-filter
- Cord & Hose Straps
- Bag filter 5 pak



CLEANUP

WARTHOG



Air Powered Poly & Steel Tanks

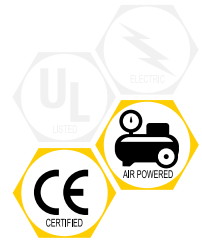

Vacuums al la carte - Choose your own hose and tools.

- **Poly Tanks** are light weight and won't dent, crack, or rust, providing years of worry free performance in harsh or wet environments.

WartHog Cleanup Air Poly

(79 dBA)

Model	NSN	Tank Capacity gal (liters)	Consumption	CFM (lpm)	Vacuum "H2O (mbar)	Weight lbs (kg)	Price
WC-105-4		5 (19)	60 CFM @ 90 PSI (1699 lpm @ 621kPa)	105 (2973)	180 (447)	23	
WC-115-4		15 (57)	60 CFM @ 90 PSI (1699 lpm @ 621kPa)	105 (2973)	180 (447)	44	

- **Steel Tanks** and dollies are heavy weight powder coated steel and won't burn or melt.

WartHog Cleanup Air Steel

(79 dBA)

Model	NSN	Tank Capacity gal (liters)	Consumption	CFM (lpm)	Vacuum "H2O (mbar)	Weight lbs (kg)	Price
WC-202-4		2 (7.5)	60 CFM @ 90 PSI (1699 lpm @ 621kPa)	105 (2973)	180 (447)		
WC-205-4		5 (19)				23	
WC-215-4		15 (57)				44	
WC-230-4		30 (115)					



Vacuum Kits

- Order your WartHog with a hose below and save!
- Additional Kits Available at the end of this section!

WartHog Cleanup Pneumatic Kits

Model	NSN	Description	Price
WC-105-4-A000		WartHog Cleanup HEPA Vac 5G Air Poly & Hose	
WC-115-4-A000		WartHog Cleanup HEPA Vac 15G Air Poly & Hose	
WC-205-4-A000		WartHog Cleanup HEPA Vac 5G Air Steel & Hose	
WC-215-4-A000		WartHog Cleanup HEPA Vac 15G Air Steel & Hose	
WC-230-4-A000		WartHog Cleanup HEPA Vac 30G Air Steel & Hose	



15' Cleanup Hose

AERO

WARTHOG



Electric Poly & Steel Tanks

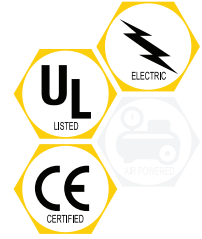

• **WartHog HEPA Aero Vacs** are an ideal solution for dustless sanding, dust extraction, and general cleanup. They provide the airflow, filtration, and durability expected from an industrial vacuum, and are designed for the removal of coatings containing Hexavalent Chromium (Cr VI), lead, cadmium and other heavy metals, carbon fiber, ceramic dust, fiberglass, mold, and asbestos. These units feature extra heavy duty components that ensure long life and extreme durability for industrial and military environments. Components are modular and field serviceable for easy replacement after years of service. Aerospace features include a grounding jack to eliminate static buildup and a Safe Filter Change port for containment of hazardous dust when changing filters.

• **Electric Power Heads** feature a heavy duty 2hp 2 stage peripheral bypass 11A motor. Aerospace features include a pressure differential gauge for monitoring filter condition.

Features

- Self closing vacuum port
- Screw on H14 HEPA filter captures 99.995% of particles 0.3µm and larger
- 5 or 15 Gal Capacities

Includes

- HEPA filter / Pre-filter
- Cord & Hose Straps
- Bag filter 5 pak



WartHog Aero Electric NSN Kits

Model	NSN	Description	Price
WH-105-0-A001	4130-01-459-0656	WartHog Aero HEPA Vac 5G 120V Poly Cleanup Kit	
WH-105-0-A011	4130-01-459-0563	WartHog Aero HEPA Vac 5G 120V Poly & FOD Kit	
WH-115-0-A002	7910-01-544-9446	WartHog Aero HEPA Vac 15G 120V Poly HD Cleanup Kit	



Electric Poly & Steel Tanks

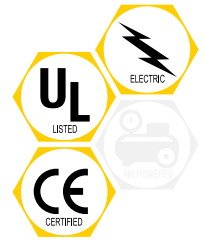

Vacuums al la carte - Choose your own hose and tools.

- **Poly Tanks** are light weight and won't dent, crack, or rust, providing years of worry free performance in harsh or wet environments.

WartHog Aero Electric Poly

(83 dBA - 2hp)

Model	NSN	Tank Capacity gal (liters)	Consumption	CFM (lpm)	Vacuum "H2O (mbar)	Weight lbs (kg)	Price
WH-105-0		5 (19)	120V @ 11.4A	105 (2973)	110 (274)	25	
WH-115-0		15 (57)					
WH-105-1		5 (19)	220-240V @ 11.4A	100 (2832)	105 (261)	25	
WH-115-1		15 (57)					

- **Steel Tanks** and dollies are heavy weight powder coated steel and won't burn or melt.

WartHog Aero Electric Steel

(83 dBA - 2hp)

Model	NSN	Tank Capacity gal (liters)	Consumption	CFM (lpm)	Vacuum "H2O (mbar)	Weight lbs (kg)	Price
WH-202-0		2 (7.5)	120VAC @ 11.4A	105 (2973)	110 (274)	25	
WH-205-0		5 (19)					
WH-215-0		15 (57)					
WH-202-1		2 (7.5)	220-240V @ 11.4A	100 (2832)	105 (261)	25	
WH-205-1		5 (19)					
WH-215-1		15 (57)					



Vacuum Kits

- Order your Warthog with a hose below and save!
- Additional Kits Available at the end of this section!

WartHog Aero Electric Kits

Model	NSN	Description	Price
WH-105-0-A000	4130-01-458-8679	WartHog Aero HEPA Vac 5G 120V Poly & Hose	
WH-115-0-A000			
WH-205-0-A000			
WH-215-0-A000	4130-01-459-0584	WartHog Aero HEPA Vac 15G 120V Steel & Hose	



15' Cleanup Hose

AERO

— WARTHOG —



Air Powered Poly & Steel Tanks

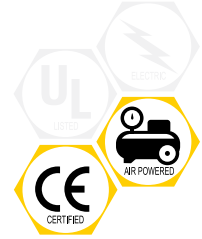

• **WartHog HEPA Aero Vacs** are an ideal solution for dustless sanding, dust extraction, and general cleanup. They provide the airflow, filtration, and durability expected from an industrial vacuum, and are designed for the removal of coatings containing Hexavalent Chromium (Cr VI), lead, cadmium and other heavy metals, carbon fiber, ceramic dust, fiberglass, mold, and asbestos. These units feature extra heavy duty components that ensure long life and extreme durability for industrial and military environments. Components are modular and field serviceable for easy replacement after years of service. Aerospace features include a grounding jack to eliminate static buildup and a Safe Filter Change port for containment of hazardous dust when changing filters.

• **Pneumatic (Air) Power Heads** feature a machined aluminum, adjustable, peripheral injection, annular venturi.

Features

- Self closing vacuum port
- Screw on H14 HEPA filter captures 99.995% of particles 0.3µm and larger
- 5 or 15 Gal Capacities

Includes

- HEPA filter / Pre-filter
- Cord & Hose Straps
- Bag filter 5 pak

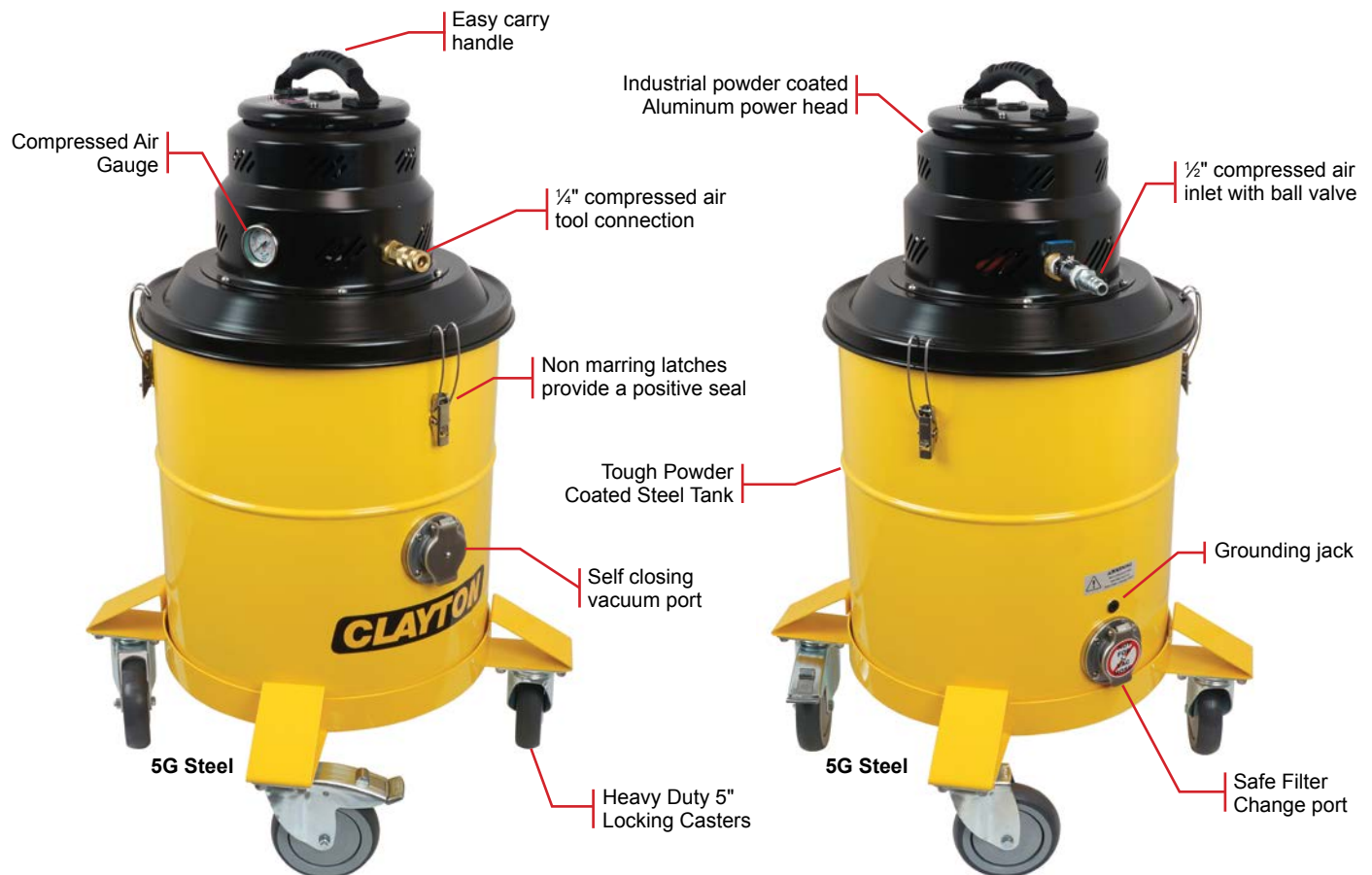

WartHog Aero Pneumatic NSN Kits

Model	NSN	Description	Price
WH-105-4-A011	4130-01-503-9359	WartHog Aero HEPA Vac 5G Air Poly & FOD Kit	



Air Powered Poly & Steel Tanks

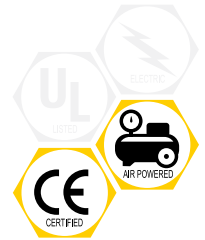

Vacuums a la carte - Choose your own hose and tools.

- Poly Tanks are light weight and won't dent, crack, or rust, providing years of worry free performance in harsh or wet environments.

Warthog Aero Air Poly

(79 dBA)

Model	NSN	Tank Capacity gal (liters)	Consumption	CFM (lpm)	Vacuum "H2O (mbar)	Weight lbs (kg)	Price
WH-105-4		5 (19)	60 CFM @ 90 PSI (1699 lpm @ 621kPa)	105 (2973)	180 (447)	23	
WH-115-4		15 (57)	60 CFM @ 90 PSI (1699 lpm @ 621kPa)	105 (2973)	180 (447)	44	

- **Steel Tanks** and dollies are heavy weight powder coated steel and won't burn or melt.

Warthog Aero Air Steel

(79 dBA)

Model	NSN	Tank Capacity gal (liters)	Consumption	CFM (lpm)	Vacuum "H2O (mbar)	Weight lbs (kg)	Price
WH-202-4		2 (7.5)	60 CFM @ 90 PSI (1699 lpm @ 621kPa)	105 (2973)	180 (447)		
WH-205-4		5 (19)				23	
WH-215-4		15 (57)				44	



Vacuum Kits

- Order your Warthog with a hose below and save!
- Additional Kits Available at the end of this section!

Warthog Aero Pneumatic Kits

Model	NSN	Description	Price
WH-105-4-A000	4130-01-459-0556	Warthog Aero HEPA Vac 5G Air Poly & Hose	
WH-115-4-A000			
WH-205-4-A000			
WH-215-4-A000	4130-01-459-0559	Warthog Aero HEPA Vac 15G Air Steel & Hose	



WET/DRY

WARTHOG



Electric Poly Tank

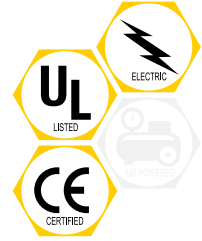

• **WartHog HEPA Wet/Dry Vacs** are an ideal solution for dust extraction and general cleanup. They provide the airflow, filtration, and durability expected from an industrial vacuum, and are designed for the removal of coatings containing Hexavalent Chromium (Cr VI), lead, cadmium and other heavy metals, carbon fiber, ceramic dust, fiberglass, mold, and asbestos. These units feature extra heavy duty components that ensure long life and extreme durability for industrial and military environments. Components are modular and field serviceable for easy replacement after years of service. Includes water level automatic shutoff for picking up bulk liquids or wet debris without HEPA filter.

• **Poly Tanks** are light weight and won't dent, crack, or rust, providing years of worry free performance in harsh or wet environments.

• **Electric Power Heads** feature a heavy duty 2hp 2 stage peripheral bypass 11A motor.

Features

- Screw on Hydrophobic HEPA filter captures 99.97% of particles 0.3µm and larger
- Self closing vacuum port
- Water Level Auto Shutoff
- 5 or 15 Gal Capacities

Includes

- HEPA filter / Pre-filter
- Cord & Hose Straps
- Bag filter 5 pak



WartHog Wet/Dry Electric Poly

(83 dBA - 2hp)

Model	NSN	Tank Capacity gal (liters)	Consumption	CFM (lpm)	Vacuum "H2O (mbar)	Weight lbs (kg)	Price
WW-105-0		5 (19)	120V @ 11.4A	105 (2973)	110 (274)	25	
WW-115-0		15 (57)				47	
WW-105-1		5 (19)	220-240V @ 11.4A	100 (2832)	105 (261)	25	
WW-115-1		15 (57)					

WartHog Wet/Dry Electric Kits

Model	NSN	Description	Price
WW-105-0-A010		WartHog Wet-Dry HEPA Vac 5G 120V Poly & Cleanup Kit	
WW-115-0-A010	4130-01-459-5894	WartHog Wet-Dry HEPA Vac 15G 120V w Cleanup Kit	



15' Cleanup Hose



Call 732-363-2100 / 800 248-8650 or Order 24 hours a day from our website @ www.JClayton.com



WET / DRY

WARTHOG



Air Powered Poly Tank

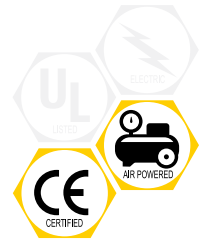

• **WartHog HEPA Wet/Dry Vacs** are an ideal solution for dust extraction and general cleanup. They provide the airflow, filtration, and durability expected from an industrial vacuum, and are designed for the removal of coatings containing Hexavalent Chromium (Cr VI), lead, cadmium and other heavy metals, carbon fiber, ceramic dust, fiberglass, mold, and asbestos. These units feature extra heavy duty components that ensure long life and extreme durability for industrial and military environments. Components are modular and field serviceable for easy replacement after years of service. Includes water level automatic shutoff for picking up bulk liquids or wet debris without HEPA filter.

• **Poly Tanks** are light weight and won't dent, crack, or rust, providing years of worry free performance in harsh or wet environments.

• **Air Pneumatic Power Heads** feature a machined aluminum, adjustable, peripheral injection, annular venturi.

Features

- Screw on Hydrophobic HEPA filter captures 99.97% of particles 0.3µm and larger
- Self closing vacuum port
- Water Level Auto Shutoff
- 5 or 15 Gal Capacities

Includes

- HEPA filter / Pre-filter
- Cord & Hose Straps
- Bag filter 5 pak



WartHog Wet/Dry Air Poly

(79 dBA)

Model	NSN	Tank Capacity gal (liters)	Consumption	CFM (lpm)	Vacuum "H2O (mbar)	Weight lbs (kg)	Price
WW-105-4		5 (19)	60 CFM @ 90 PSI (1699 lpm @ 621kPa)	105 (2973)	180 (447)	23	
WW-115-4		15 (57)	60 CFM @ 90 PSI (1699 lpm @ 621kPa)	105 (2973)	180 (447)	44	

WartHog Wet/Dry Pneumatic Kits

Model	NSN	Description	Price
WW-105-4-A010		WartHog Wet-Dry HEPA Vac 5G Air Poly & Cleanup Kit	
WW-115-4-A010	4130-01-459-5895	WartHog Wet-Dry HEPA Vac 15G Air Poly & Cleanup Kit	



Call 732-363-2100 / 800 248-8650 or Order 24 hours a day from our website @ www.JClayton.com



WartHog Kits

WartHog Cleanup Kits include vacuum, hose, one set of cleaning tools, tool control belt, and compressed airline (pneumatic vacs only)

WartHog Cleanup Kits Add this suffix to any Warthog	-A000	-A001	-A002	-A011
Cleanup Hose	✓	✓	✓	✓
Compressed Air Line 30' x 1/2"	x	x	x	x
Tool Control Kit		✓	✓	✓
Cleanup Tools Light Duty		✓		
Cleanup Tools Heavy Duty			✓	
Cleanup Tools HD Wheeled				✓
Cleanup Tools FOD Kit				✓

x Pneumatic Only



Compressed Airline



15' Cleanup Hose



Light Duty



Heavy Duty



Heavy Duty Wheeled



FOD

WartHog Sanding Kits include vacuum, hose, sander, abrasives, plus a host of other items. See table below for a complete list.

WartHog Sanding Kits Add this suffix to any Warthog	-1000	-600	-500
Cleanup Hose		✓	
Combination Hose 1 1/2" x 20'	✓		✓
Compressed Air Line 30' x 1/2"	x	x	x
3" DA Sander	✓		
5" DA Sander			✓
6" DA Sander	✓	✓	
3" Backup Pads 3 pak	✓		
6" Backup Pads 3 pak	✓		
3" Pad Protectors 50 pak	✓		
6" Pad Protectors 50 pak	✓		
3" 80 grit abrasive 250 pak	✓		
3" 120 grit abrasive 250 pak	✓		
3" 180 grit abrasive 250 pak	✓		
6" 80 grit abrasive 250 pak	✓		
6" 120 grit abrasive 250 pak	✓		
6" 180 grit abrasive 250 pak	✓		

x Pneumatic Only



15' Cleanup Hose



3" DA



5" DA



6" DA



Compressed Airline



Combination Hose

WartHog Accessories

WartHog Consumables

Model	NSN	Description	Price
627-12H	4310-01-520-6794	HEPA Filter Warthog	
627-12P		PreFilter Warthog 3pk	
627-0913B	4130-01-459-1257	Filter Bag 5 Gal Poly 5pk	
627-1414B		Filter Bag 5 Gal Steel 5pk	
627-16B	7910-01-459-0352	Filter Bag 15 Gal Warthog 5pk	
627-30B		Filter Bag 30 Gal Warthog 5pk	



627-12H



627-12P



627-0913B



627-1414B



627-16B

WartHog Accessories

Model	NSN	Description	Price
630-A004-05		Tool Control Belt (WartHog 5 gal)	
630-A004-15		Tool Control Belt (WartHog 15 gal)	
630-A004-30		Tool Control Belt (WartHog 30 gal)	
922-A08H30	4130-01-460-1337	Airline 1/2" x 30'	
671-VHX24-20	4130-01-460-1448	Vacuum Hose 1-1/2" x 20' (Static conductive)	
671-VHA24-003		Safe Filter Change Hose	
926-A08F40-01		Compressed Air Filter Integrated	
926-A08F40-02		Compressed Air Filter Quick Disconnect	



Vacuum Hose
Additional Lengths Available



Safe-Filter-Change Hose



Compressed Airline
Additional Lengths Available



Tool Control Belt



Air Filter
Integrated

Air Filter
Quick Disconnect

TWIN TECH

VACUUM MOUNTED WORKCENTER

A cool place for your sanders to hang out at break time.

Features

- Mounts to 15 gallon poly tank
- Storage for two sanders & two 30ft hoses
- Pegboard with hooks and bins
- Two work surfaces
- Paper towel holder
- Replaces existing vacuum handle

SEE STORAGE SECTION FOR MORE DETAILS





WARTHOG G2

Industrial & Aerospace HEPA Vacuums

General Dust

Toxic Dust

Cleanup

- Absolute HEPA
- Electric or Pneumatic
- Poly or Steel Tank

• Designed for general cleanup and house keeping where absolute HEPA filtration is required.

Dustless Sanding

- Absolute HEPA
- Electric or Pneumatic
- Poly or Steel Tank
- Auto on/off for Air Tools
- Auto on/off for Electric Tools

• Designed for dustless sanding and cleanup where absolute HEPA filtration is required.

Cleanup

- Absolute HEPA
- Electric or Pneumatic
- Poly or Steel Tank
- Safe Filter Change
- Grounded / Bonded
- Filter Health Gauge

• Designed for general cleanup and housekeeping where Safe-Filter-Change and static buildup are an issue.

Dustless Sanding

- Absolute HEPA
- Electric or Pneumatic
- Poly or Steel Tank
- Safe Filter Change
- Grounded / Bonded
- Filter Health Gauge
- Auto on/off for Air Tools

• Designed for dustless sanding and cleanup where Safe-Filter-Change and static buildup are an issue.

CLEANUP

— WARTHOG — MANUAL ON/OFF —



Designed for General Cleanup & Housekeeping (1-2 Users)

Best for the collection of dry dust & debris where absolute HEPA filtration is required.

Electric



Heavy duty 2 hp 2 stage peripheral bypass motor

On/Off toggle switch

Industrial powder coated stainless steel power head

30' grounded power cord

Air Powered



Machined aluminum air powered venturi

Compressed air pressure gauge

Self closing vacuum port

Tough poly or powder coated steel tank

1/2" compressed air inlet with ball valve

Heavy gauge stainless steel handle

Large knobby tires

Heavy duty 2" casters

CLEANUP

WARTHOG ——— MANUAL ON/OFF



Electric Poly & Steel Tanks

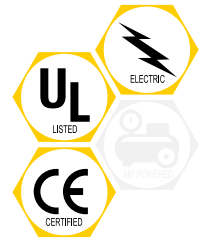

Features:

- Screw on H14 HEPA filter captures 99.995% of particles 0.3µm and larger
- Self-Closing Inlet
- Manual On/Off
- 30ft 15A Power Cord

Includes:

- HEPA Filter / Pre-filter
- Bag Filter 5 Pak

WartHog Electric - General Cleanup Poly (67 dBA - 2hp)

Model	NSN	Tank Capacity gal (liters)	Consumption	CFM (lpm)	Vacuum "H2O (mbar)	Weight lbs (kg)	Price
WGX-107G-0		7 (26)	120V 13.5A	120 (3398)	120 (298)		
WGX-107G-1		7 (26)	220-240V 7.5	115 (3256)	115 (286)		
WGX-115G-0		15 (57)	120V 13.5A	120 (3398)	120 (298)		
WGX-115G-1		15 (57)	220-240V 7.5	115 (3256)	115 (286)		



30-Gal Steel Tank

WartHog Electric - General Cleanup Steel (67 dBA - 2hp)

Model	NSN	Tank Capacity gal (liters)	Consumption	CFM (lpm)	Vacuum "H2O (mbar)	Weight lbs (kg)	Price
WGX-205G-0		5 (19)	120V 13.5A	120 (3398)	120 (298)		
WGX-215G-0		15 (57)					
WGX-230G-0		30 (115)					
WGX-205G-1		5 (19)	220-240V 7.5A	115 (3256)	115 (286)		
WGX-215G-1		15 (57)					
WGX-230G-1		30 (115)					



7-Gal Poly Tank



15-Gal Poly Tank



15-Gal Steel Tank



5-Gal Steel Tank

CLEANUP

— WARTHOG — MANUAL ON/OFF —



Air Powered Poly & Steel Tanks

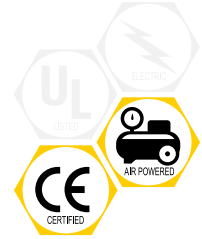

Features:

- Screw on H14 HEPA filter captures 99.995% of particles 0.3µm and larger
- Self-Closing Inlet
- Manual On/Off

Includes:

- HEPA Filter / Pre-filter
- Bag Filter 5 Pak

WartHog Air - General Cleanup Poly

(67 dBA - 2hp)

Model	NSN	Tank Capacity gal (liters)	Consumption	CFM (lpm)	Vacuum "H2O (mbar)	Weight lbs (kg)	Price
WGX-107G-4		7 (26)	60 CFM @ 90 PSI (1699 lpm @ 621kPa)	105 (2973)	180 (447)		
WGX-115G-4		15 (57)	60 CFM @ 90 PSI (1699 lpm @ 621kPa)	105 (2973)	180 (447)		

WartHog Air - General Cleanup Steel

(67 dBA - 2hp)

Model	NSN	Tank Capacity gal (liters)	Consumption	CFM (lpm)	Vacuum "H2O (mbar)	Weight lbs (kg)	Price
WGX-205G-4		5 (19)	60 CFM @ 90 PSI (1699 lpm @ 621kPa)	105 (2973)	180 (447)		
WGX-215G-4		15 (57)					
WGX-230G-4		30 (115)					



30-Gal Steel Tank



7-Gal Poly Tank



15-Gal Poly Tank



15-Gal Steel Tank



5-Gal Steel Tank

SANDING

— WARTHOG — PNEUMATIC AUTO ON/OFF —



Designed for Dustless Sanding with Pneumatic Sanders (1-2 Users)

Best for the collection of dry dust & debris from sanding operations where absolute HEPA filtration is required.

Electric



Air Powered



SANDING

— WARTHOG — PNEUMATIC AUTO ON/OFF —



Electric Poly & Steel Tanks

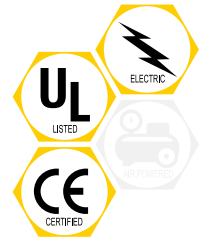

Features:

- Screw on H14 HEPA filter captures 99.995% of particles 0.3µm and larger
- Self-Closing Inlet
- Manual On/Off
- Auto On/Off for 2 Air Tools
- 30ft 15A Power Cord
- Auto System Time Delay Adjustment
- Auto System Time Delay Gauge

Includes:

- HEPA Filter / Pre-filter
- Bag Filter 5 Pak

WartHog Electric - Auto Pneumatic Poly

(67 dBA - 2hp)

Model	NSN	Tank Capacity gal (liters)	Consumption	CFM (lpm)	Vacuum "H2O (mbar)	Weight lbs (kg)	Price
WGP-107G-0		7 (26)	120V 13.5A	120 (3398)	120 (298)		
WGP-107G-1		7 (26)	220-240V	115 (3256)	115 (286)		
WGP-115G-0		15 (57)	120V 13.5A	120 (3398)	120 (298)		
WGP-115G-1		15 (57)	220-240V	115 (3256)	115 (286)		



30-Gal Steel Tank

WartHog Electric - Auto Pneumatic Steel

(67 dBA - 2hp)

Model	NSN	Tank Capacity gal (liters)	Consumption	CFM (lpm)	Vacuum "H2O (mbar)	Weight lbs (kg)	Price
WGP-205G-0		5 (19)	120V 13.5A	120 (3398)	120 (298)		
WGP-215G-0		15 (57)					
WGP-230G-0		30 (115)					
WGP-205G-1		5 (19)	220-240V	115 (3256)	115 (286)		
WGP-215G-1		15 (57)					
WGP-230G-1		30 (115)					



7-Gal Poly Tank



15-Gal Poly Tank



15-Gal Steel Tank



5-Gal Steel Tank



Call 732-363-2100 / 800 248-8650 or Order 24 hours a day from our website @ www.JClayton.com



SANDING

— WARTHOG — PNEUMATIC AUTO ON/OFF —



Air Powered Poly & Steel Tanks

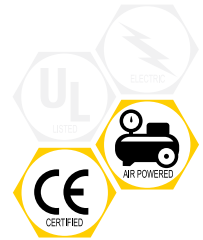

Features:

- Screw on H14 HEPA filter captures 99.995% of particles 0.3µm and larger
- Self-Closing Inlet
- Manual On/Off
- Auto On/Off for 2 Air Tools
- Auto System Time Delay Adjustment
- Auto System Time Delay Gauge

Includes:

- HEPA Filter / Pre-filter
- Bag Filter 5 Pak

WartHog Air - Auto Pneumatic Poly

Model	NSN	Tank Capacity gal (liters)	Consumption	CFM (lpm)	Vacuum "H2O (mbar)	Weight lbs (kg)	Price
WGP-107G-4		7 (26)	60 CFM @ 90 PSI (1699 lpm @ 621kPa)	105 (2973)	180 (447)		
WGP-115G-4		15 (57)	60 CFM @ 90 PSI (1699 lpm @ 621kPa)	105 (2973)	180 (447)		

WartHog Air - Auto Pneumatic Steel

(67 dBA - 2hp)

Model	NSN	Tank Capacity gal (liters)	Consumption	CFM (lpm)	Vacuum "H2O (mbar)	Weight lbs (kg)	Price
WGP-205G-4		5 (19)	60 CFM @ 90 PSI (1699 lpm @ 621kPa)	105 (2973)	180 (447)		
WGP-215G-4		15 (57)					
WGP-230G-4		30 (115)					



30-Gal Steel Tank



7-Gal Poly Tank



15-Gal Poly Tank



15-Gal Steel Tank



5-Gal Steel Tank

SANDING



— WARTHOG — PNEUMATIC OR ELECTRIC AUTO ON/OFF —

Designed for Dustless Sanding with Pneumatic and Electric Sanders (1-2 Users)

Best for the collection of dry dust & debris from sanding operations where absolute HEPA filtration is required.

Electric



SANDING



— WARTHOG — PNEUMATIC OR ELECTRIC AUTO ON/OFF —

Electric Poly & Steel Tanks

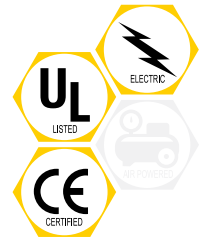

Features:

- Screw on H14 HEPA filter captures 99.995% of particles 0.3µm and larger
- Self-Closing Inlet
- Manual On/Off
- Auto On/Off for 2 Air Tools
- Auto On/Off for 2 Electric Tools
- 30ft 20A Power Cord
- Auto System Time Delay Adjustment
- Auto System Time Delay Gauge

Includes:

- HEPA Filter / Pre-filter
- Bag Filter 5 Pak

Warthog Electric - Auto Combo Poly

(67 dBA - 2hp)

Model	NSN	Tank Capacity gal (liters)	Consumption	CFM (lpm)	Vacuum "H2O (mbar)	Weight lbs (kg)	Price
WGC-107G-0		7 (26)	120V 13.5A	120 (3398)	120 (298)		
WGC-107G-1		7 (26)	220-240V 7.5"	115 (3256)	115 (286)		
WGC-115G-0		15 (57)	120V 13.5A	120 (3398)	120 (298)		
WGC-115G-1		15 (57)	220-240V 7.5	115 (3256)	115 (286)		

Warthog Electric - Auto Combo Steel

(67 dBA - 2hp)

Model	NSN	Tank Capacity gal (liters)	Consumption	CFM (lpm)	Vacuum "H2O (mbar)	Weight lbs (kg)	Price
WGC-205G-0		5 (19)	120V 13.5A	120 (3398)	120 (298)		
WGC-215G-0		15 (57)					
WGC-230G-0		30 (115)					
WGC-205G-1		5 (19)	220-240V 7.5A	115 (3256)	115 (286)		
WGC-215G-1		15 (57)					
WGC-230G-1		30 (115)					



30-Gal Steel Tank



7-Gal Poly Tank



15-Gal Poly Tank



15-Gal Steel Tank



5-Gal Steel Tank

CLEANUP

— WARTHOG — MANUAL ON/OFF —



Designed for Toxic Cleanup & Housekeeping (1-2 Users)

Best for the collection of dry dust & debris where absolute HEPA filtration is required. Vacuums include a Differential Pressure Gauge for filter monitoring, grounding / bonding jack, and Safe-Filter-Change port for in situ bag changes.

Electric



Air Powered



CLEANUP

WARTHOG ——— MANUAL ON/OFF



Electric Poly & Steel Tanks

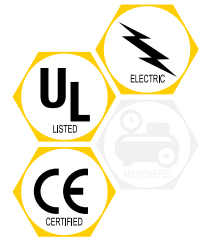

Features:

- Screw on H14 HEPA filter captures 99.995% of particles 0.3µm and larger
- Self-Closing Inlet
- Manual On/Off
- 30ft 15A Power Cord
- Differential Pressure / Filter Change Gauge
- Safe-Filter-Change Port
- Grounding / Bonding Jack

Includes:

- HEPA Filter / Pre-filter
- Bag Filter 5 Pak

WartHog Electric - Toxic Cleanup Poly

(67 dBA - 2hp)

Model	NSN	Tank Capacity gal (liters)	Consumption	CFM (lpm)	Vacuum "H2O (mbar)	Weight lbs (kg)	Price
WTX-107T-0		7 (26)	120V 13.5A	120 (3398)	120 (298)		
WTX-107T-1		7 (26)	220-240V 7.5	115 (3256)	115 (286)		
WTX-115T-0		15 (57)	120V 13.5A	120 (3398)	120 (298)		
WTX-115T-1		15 (57)	220-240V 7.5	115 (3256)	115 (286)		

WartHog Electric - Toxic Cleanup Steel

(67 dBA - 2hp)

Model	NSN	Tank Capacity gal (liters)	Consumption	CFM (lpm)	Vacuum "H2O (mbar)	Weight lbs (kg)	Price
WTX-205T-0		5 (19)	120V 13.5A	120 (3398)	120 (298)		
WTX-215T-0		15 (57)					
WTX-215T-0		15 (57)	220-240V 7.5A	115 (3256)	115 (286)		
WTX-205T-1		5 (19)					
WTX-215T-1		15 (57)					
WTX-230T-1		30 (115)					



30-Gal Steel Tank



7-Gal Poly Tank



15-Gal Poly Tank



15-Gal Steel Tank



5-Gal Steel Tank

CLEANUP

WARTHOG MANUAL ON/OFF



Features:

- Screw on H14 HEPA filter captures 99.995% of particles 0.3µm and larger
- Self-Closing Inlet
- Manual On/Off
- Safe-Filter-Change Port
- Grounding / Bonding Jack

Includes:

- HEPA Filter / Pre-filter
- Bag Filter 5 Pak



Air Powered Poly & Steel Tanks

WartHog Air - Toxic Cleanup Poly

(67 dBA - 2hp)

Model	NSN	Tank Capacity gal (liters)	Consumption	CFM (lpm)	Vacuum "H2O (mbar)	Weight lbs (kg)	Price
WTX-107T-4		7 (26)	60 CFM @ 90 PSI (1699 lpm @ 621kPa)	105 (2973)	180 (447)		
WTX-115T-4		15 (57)	60 CFM @ 90 PSI (1699 lpm @ 621kPa)	105 (2973)	180 (447)		

WartHog Air - Toxic Cleanup Steel

(67 dBA - 2hp)

Model	NSN	Tank Capacity gal (liters)	Consumption	CFM (lpm)	Vacuum "H2O (mbar)	Weight lbs (kg)	Price
WTX-205T-4		5 (19)	60 CFM @ 90 PSI (1699 lpm @ 621kPa)	105 (2973)	180 (447)		
WTX-215T-4		15 (57)					
WTX-230T-4		30 (115)					



30-Gal Steel Tank



7-Gal Poly Tank



15-Gal Poly Tank



15-Gal Steel Tank



5-Gal Steel Tank

SANDING

— WARTHOG — PNEUMATIC AUTO ON/OFF —



Designed for Toxic Dustless Sanding with Pneumatic Sanders (1-2 Users)

Best for the collection of dry dust & debris from sanding operations where absolute HEPA filtration is required. Vacuums include a Differential Pressure Gauge for filter monitoring, grounding / bonding jack, and Safe-Filter-Change port for in situ bag changes.

Electric



Air Powered



SANDING

— WARTHOG — PNEUMATIC AUTO ON/OFF —



Electric Poly & Steel Tanks

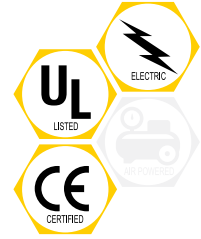

Features:

- Screw on H14 HEPA filter captures 99.995% of particles 0.3µm and larger
- Self-Closing Inlet
- Manual On/Off
- Auto On/Off for 2 Air Tools
- 30ft 15A Power Cord
- Auto System Time Delay Adjustment
- Auto System Time Delay Gauge
- Differential Pressure / Filter Change Gauge
- Safe-Filter-Change Port
- Grounding / Bonding Jack

Includes:

- HEPA Filter / Pre-filter
- Bag Filter 5 Pak

WartHog Air - Toxic Auto Pneumatic Poly

(67 dBA - 2hp)

Model	NSN	Tank Capacity gal (liters)	Consumption	CFM (lpm)	Vacuum "H2O (mbar)	Weight lbs (kg)	Price
WTP-107T-0		7 (26)	120V 13.5A	120 (3398)	120 (298)		
WTP-107T-1		7 (26)	220-240V 7.5	115 (3256)	115 (286)		
WTP-115T-0		15 (57)	120V 13.5A	120 (3398)	120 (298)		
WTP-115T-1		15 (57)	220-240V 7.5	115 (3256)	115 (286)		

WartHog Air - Toxic Auto Pneumatic Steel

(67 dBA - 2hp)

Model	NSN	Tank Capacity gal (liters)	Consumption	CFM (lpm)	Vacuum "H2O (mbar)	Weight lbs (kg)	Price
WTP-205T-0		5 (19)	120V 13.5A	120 (3398)	120 (298)		
WTP-215T-0		15 (57)					
WTP-230T-0		30 (115)					
WTP-205T-1		5 (19)	220-240V 7.5A	115 (3256)	115 (286)		
WTP-215T-1		15 (57)					
WTP-230T-1		30 (115)					



30-Gal Steel Tank



7-Gal Poly Tank



15-Gal Poly Tank



15-Gal Steel Tank



5-Gal Steel Tank



Call 732-363-2100 / 800 248-8650 or Order 24 hours a day from our website @ www.JClayton.com



SANDING

— WARTHOG — PNEUMATIC AUTO ON/OFF —



Air Powered Poly & Steel Tanks

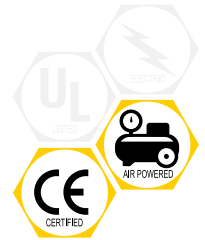

Features:

- Screw on H14 HEPA filter captures 99.995% of particles 0.3µm and larger
- Self-Closing Inlet
- Manual On/Off
- Auto On/Off for 2 Air Tools
- Auto System Time Delay Adjustment
- Auto System Time Delay Gauge
- Safe-Filter-Change Port
- Grounding / Bonding Jack

Includes:

- HEPA Filter / Pre-filter
- Bag Filter 5 Pak

WarHog Air - Toxic Auto Pneumatic Poly

(67 dBA - 2hp)

Model	NSN	Tank Capacity gal (liters)	Consumption	CFM (lpm)	Vacuum "H2O (mbar)	Weight lbs (kg)	Price
WTP-107T-4		7 (26)	60 CFM @ 90 PSI (1699 lpm @ 621kPa)	105 (2973)	180 (447)		
WTP-115T-4		15 (57)	60 CFM @ 90 PSI (1699 lpm @ 621kPa)	105 (2973)	180 (447)		

WarHog Air - Toxic Auto Pneumatic Steel

(67 dBA - 2hp)

Model	NSN	Tank Capacity gal (liters)	Consumption	CFM (lpm)	Vacuum "H2O (mbar)	Weight lbs (kg)	Price
WTP-205T-4		5 (19)	60 CFM @ 90 PSI (1699 lpm @ 621kPa)	105 (2973)	180 (447)		
WTP-215T-4		15 (57)					
WTP-230T-4		30 (115)					



30-Gal Steel Tank



7-Gal Poly Tank

15-Gal Poly Tank

15-Gal Steel Tank

5-Gal Steel Tank

SANDING



— WARTHOG — PNEUMATIC OR ELECTRIC AUTO ON/OFF —

Designed for Dustless Sanding with Pneumatic and Electric Sanders (1-2 Users)

Best for the collection of dry dust & debris from sanding operations where absolute HEPA filtration is required. Vacuums include a Differential Pressure Gauge for filter monitoring, grounding / bonding jack, and Safe-Filter-Change port for in situ bag changes.

Electric



SANDING



— WARTHOG — PNEUMATIC OR ELECTRIC AUTO ON/OFF —

Electric Poly & Steel Tanks

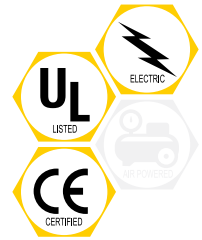

Features:

- Screw on H14 HEPA filter captures 99.995% of particles 0.3µm and larger
- Self-Closing Inlet
- Manual On/Off
- Auto On/Off for 2 Air Tools
- Auto On/Off for Electric Tools
- 30ft 15A Power Cord
- Auto System Time Delay Adjustment
- Auto System Time Delay Gauge
- Differential Pressure / Filter Change Gauge
- Safe-Filter-Change Port
- Grounding / Bonding Jack

Includes:

- HEPA Filter / Pre-filter
- Bag Filter 5 Pak

Warthog Electric - Toxic Auto Combo Poly

(67 dBA - 2hp)

Model	NSN	Tank Capacity gal (liters)	Consumption	CFM (lpm)	Vacuum "H2O (mbar)	Weight lbs (kg)	Price
WTC-107T-0		7 (26)	120V 13.5A	120 (3398)	120 (298)		
WTC-107T-1		7 (26)	220-240V 7.5	115 (3256)	115 (286)		
WTC-115T-0		15 (57)	120V 13.5A	120 (3398)	120 (298)		
WTC-115T-1		15 (57)	220-240V 7.5	115 (3256)	115 (286)		

Warthog Electric - Toxic Auto Combo Steel

(67 dBA - 2hp)

Model	NSN	Tank Capacity gal (liters)	Consumption	CFM (lpm)	Vacuum "H2O (mbar)	Weight lbs (kg)	Price
WTC-205T-0		5 (19)	120V 13.5A	120 (3398)	120 (298)		
WTC-215T-0		15 (57)					
WTC-230T-0		30 (115)					
WTC-205T-1		5 (19)	220-240V 7.5A	115 (3256)	115 (286)		
WTC-215T-1		15 (57)					
WTC-230T-1		30 (115)					



30-Gal Steel Tank



7-Gal Poly Tank



15-Gal Poly Tank



15-Gal Steel Tank



5-Gal Steel Tank



Call 732-363-2100 / 800 248-8650 or Order 24 hours a day from our website @ www.JClayton.com



Barracuda Two User Immersion Vac / Separator



Designed specifically for the capture of live sparks, embers, and combustible dust, like aluminum and titanium, the Barracuda's powerful vacuum motor draws air and collected particulate into the immersion tank, and forces it through a roiling water bath, instantly quenching sparks, and thoroughly wetting dust out of the airstream. Three stages of additional filtration ensure that the air exhausted from the system is dust and moisture free.

When it's time to empty the tank, simply pull the valve lever to dump the water and debris out through a filter sock and into any floor drain. Once the tank is empty, connect the system to a normal garden hose, and a series of spray heads inside the unit continue to flush the tank, ensuring that no sediment builds up on the internal components. The large window makes it simple to confirm the water level in the tank, and allows spectators to view the carnage as dust and debris gets consumed by the Barracuda.

Features:

- Two User
- All stainless steel construction will never rust
- Multi nozzle internal wash down system keeps the unit clean
- Large window to monitor water level and vacuum activity
- 4 stage filtration system ensures dust containment
- Drain filter for easy collection and disposal of sludge
- Low level water shutoff
- Pneumatic tool sync auto on/off

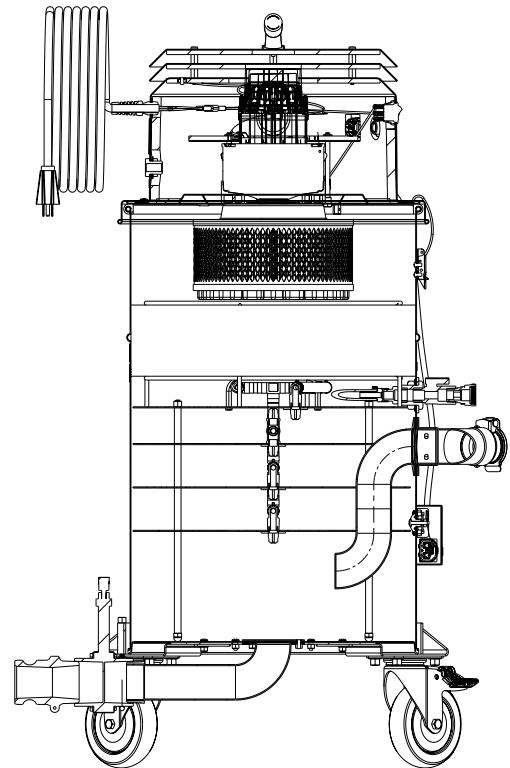

Barracuda Comparison

Barracuda Volt Immersion Vac	Barracuda Air Immersion Vac	Barracuda Immersion Pre-Separator
CMP-315C-0/1	CMP-315C-4	CMX-315C-X
		
Includes an Electric Power Head 120V, 220V, or 240V	Includes a Pneumatic Power Head Requires 60 CFM of compressed air	No Power Head Requires an External Vacuum Source 80-120 cfm

Barracuda Auto On/Off Vacs

Model	NSN	Tank Capacity gal (liters)	Consumption	CFM (lpm)	Vacuum "H2O (mbar)	dBA	HP	Weight lbs (kg)	Price
CMP-315C-0		4 (15)	120V @ 11.4A	112 (3171)	106 (263)	67	2		
CMP-315C-1			220-240V @ 6.4A	108 (3058)	100 (248)	67	2		
CMP-315C-4			60 CFM @ 90 PSI (1699 lpm @ 621kPa)	105 (2973)	180 (447)	79	-		

Barracuda Pre-Separator

Model	NSN	Tank Capacity gal (liters)							
CMX-315C-X		4 (15)							

Barracuda Consumables

Model	NSN	Description	Price
627-12C		HEPA Filter Coalescing Hydrophobic Barracuda	
627-1218M10		Filter Sock Barracuda 12 x 18 x 1mu, 5 pk	
627-16C		Coalescing Filter Stainless Steel	



Accessories for the Pneumatic Barracuda in a HazLoc environment.

Barracuda Exp Accessories

Model	NSN	Description	Price
67X-VHX24-20		Cleanup Hose 1-1/2" x 20' Conductive	
67X-AVHW2416-20		Air Vac Work Hose 20' Conductive	
92X-A08H30-II	4720-01-663-1575	Compressed Airline 30' Conductive	
630-A008		Heavy Duty Cleanup Toolkit Conductive	
900-A001-30	6150-01-671-8172	Aircraft Grounding Cable	



* see hose section for additional sizes

**HEPA Vac Accessories**

Model	NSN	Description	Price
671-VHX24-10	4130-01-460-6094	Vacuum Cleanup Hose, 1.5in X 10ft	
671-VHX24-15		Vacuum Cleanup Hose, 1.5in X 15ft	
671-VHX24-20	4130-01-460-1448	Vacuum Cleanup Hose, 1.5in X 20ft	
671-VHX24-25		Vacuum Cleanup Hose, 1.5in X 25ft	
671-AVHW2416-10	4720-01-652-0544	Air Vac Combo Hose 1.5in X 1in X 10ft	
671-AVHW2416-15	4130-01-460-6088	Air Vac Combo Hose 1.5in X 1in X 15ft	
671-AVHW2416-20	4130-01-460-1438	Air Vac Combo Hose 1.5in X 1in X 20ft	
671-AVHW2416-25		Air Vac Combo Hose 1.5in X 1in X 25ft	
630-A001		Clean Up Toolkit - 5 Piece Light Duty	
630-A002		Clean Up Toolkit - 5 Piece Heavy Duty	
922-A08H30	4130-01-460-1337	Compressed Air Hose 30ft x 1/2in Steel Fittings	

* see hose section for additional sizes

55 GALLON

DRUM ADAPTER

Designed for High Volume Collection Media Collection (1-2 Users)

When collecting high volume debris like blast media where disposing of the entire drum is desired, use our 55 gallon drum adapter. The drum adapter simply sits on any 55 gallon open head drum, and latches to any Electric or Air Powered Gen 2 Clayton Warthog HEPA Warthog power head. The drum adapter has 2 ports for 2 simultaneous users and auto shut off when the drum is full. Adapter comes with HEPA filter and 2-packs of cover bonnets. Power head, drum and dolly not included.

55 Gallon Drum Adapter

Model	NSN	Description	Price
WH-255-X		Warthog 55gal Drum Adapter Assembly	
627-12H		HEPA Filter Warthog H14	
600-M12C		Cover Bonnet HEPA Filter 2PK	

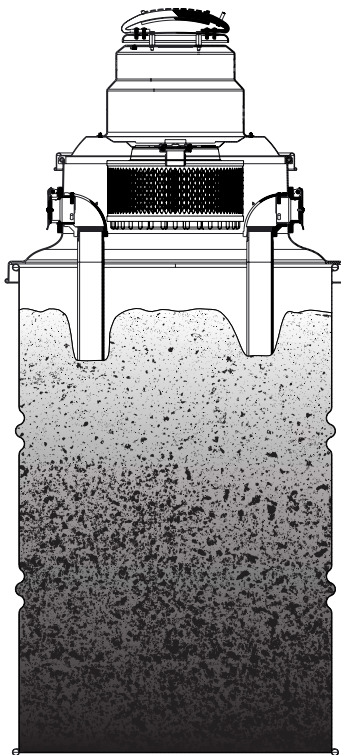

The drum adapter has 10in down tubes that protrude into the 55 gallon drum. When debris inside the tank rises to approximately 5in from the top, the down tubes are blocked and the suction ceases. This indicates that it is time to changez the drum.

DustMaster Electric & Pneumatic ULPA Vacs

Available in both **electric** and **pneumatic**, the DustMaster Series ULPA Vacs are our most powerful solution for portable dustless sanding, dust extraction, and general cleanup. They are designed for the removal of coatings containing Hexavalent Chromium (Cr VI), lead, cadmium and other heavy metals, carbon fiber, ceramic dust, fiberglass and mold. These units are portable, and include features for the most demanding applications. All components are extra heavy duty to ensure long life and extreme durability for industrial and military environments.

Three Stage Filtration

Stage 1: Filter Bag. Change as needed.

Stage 3: ULPA Filter (not visible)

Stage 2: Pre-filter is 95% efficient @ 0.3 µm. Change once a year or when Minihelic reads above 5.

Stage 3: ULPA Filter is 99.9995% efficient @ 0.12 µm (U15). Change when magnahelic reads above 5 with a new pre-filter installed. With proper maintenance and use, this filter will last several years.



Minihelic

Stage 2: Pre-filter

Stage 1: Filter Bag



Patented Safe-Filter-Change

This unique Clayton design allows workers to change disposable filters in complete safety.

- Leave vacuum running while changing filter bag; downdraft into pre-filter contains any dust trying to escape, preventing worker exposure.
- Leave vacuum running while changing pre-filter, downdraft into ULPA filter contains any dust trying to escape, preventing worker exposure.



Filter Bag change



Pre-filter change

Twin Vacuum Motors

Our Electric and Pneumatic DustMaster Vacuum systems both employ dual vacuum motors for unmatched performance and support for up to 3 simultaneous users.



Auto On / Off

Compressed air is an expensive part of running any operation. Facility managers and engineers know the real cost of compressed air is significant. The electricity required to operate large screw compressors is a huge part of the daily operating expense for a shop or hangar.

We've observed in many facilities air powered vacuums left running continuously, reducing available pressure to the facility, and putting a heavy and continuous strain on the compressor. Our engineers have put years of research and development into the design of the industry's first automatic tool sensing all pneumatic vacuum - available only from Clayton.

All pneumatic DustMaster vacuums and systems have an Auto On/Off feature which allows the vacuum to start when any connected sander, grinder, etc. is started, and an adjustable shut off delay keeps the vacuum running for up to 60 seconds after the tool is stopped.

- Vacuum can be set to ON for continuous run
- AUTO for tool actuated mode
- Shut off delay adjustable from 5 to 60 seconds



Gauge Panel



Our gauge panel helps you monitor the health and performance of your DustMaster system.

Our Auto On/Off System Pressure acts as a countdown monitor. When a connected tool is actuated the Auto System is pressurized. When the tool is stopped the shut off delay bleeds air from the Auto System and the pressure counts down to zero at which time the vacuum shuts off.

To help monitor the ULPA filter, our Minihelic compares the pressure on either side of the filter. As particles build up in the ULPA filter, the pressure difference increases. When the gauge is in the red, it's time to change the ULPA filter. With proper maintenance of the pre-filter and bag filters, the ULPA filter should last several years.

Since the DustMaster has a built in manifold for providing compressed air to your tools, it's helpful to see the Air Supply Line Pressure. This lets you know if your compressor is keeping up with demand. In a properly operating system with an adequate air supply, this gauge should remain between 80 and 100 psi.

The DustMaster System is available in 5 configurations

These configurations build on one another by adding components of the DustMaster system. These components interlock to form a single standalone unit.

- 1**

Consolidated Hose Reel & Toolkit	Cyclone
ULPA Vacs	

The DustMaster ULPA Vacuum is available as a standalone unit. This is the Heart of the DustMaster System.
- 2**

Consolidated Hose Reel & Toolkit	Cyclone
ULPA Vacs	

The Consolidated Hose Reel & Toolkit (CTK) provides storage for vacuum hoses, compressed air lines, sanders, tools, and abrasives. It's available with or without casters, and can ride atop the vacuum.
- 3**

Consolidated Hose Reel & Toolkit	Cyclone
ULPA Vacs	

In this configuration the Consolidated Hose Reel & Toolkit (CTK) rides atop the vacuum creating a single unit for easy deployment and storage.
- 4**

Consolidated Hose Reel & Toolkit	Cyclone
ULPA Vacs	

Our Cyclonic pre-separator is an add-on unit that captures 99% of debris before it gets to the primary filter bag. This means fewer filter changes and less loss of suction.
- 5**

Consolidated Hose Reel & Toolkit	Cyclone
ULPA Vacs	

Suction, tool storage, and cyclonic pre separation all in one package.

DustMaster Vacuums

Model	NSN	Power	Weight lbs (kg)	Price
DM-100	7910-01-520-6439	Electric	84 (38)	
DM-104	7910-01-520-6436	Pneumatic	77 (35)	

CTK Only

Model	NSN	Power	Weight lbs (kg)	Price
650-201	5140-01-520-8551	CTK without Casters	100 (45)	
650-301		CTK with Casters	108 (49)	

DustMaster Vacuums (CTK)

Model	NSN	Power	Weight lbs (kg)	Price
DM-100CTK		Electric	184 (83)	
DM-104CTK		Pneumatic	177 (80)	

DustMaster Systems (Cyclone)

Model	NSN	Power	Weight lbs (kg)	Price
DM-100Cyclone		Electric	164 (74)	
DM-104Cyclone		Pneumatic	167 (75)	

DustMaster Systems (CTK & Cyclone)

Model	NSN	Power	Weight lbs (kg)	Price
DM-300		Electric	207 (93)	
DM-304		Pneumatic	200 (90)	

* Available on GSA Advantage website @ www.GSAadvantage.gov





Precision tuned compressed air motors

DustMaster Electric Vacuums



Features

- Supports up to 3 users with optional Y adapter
- Uses a single compressed air line and an internal manifold to supply 3 users with compressed air
- Safe-Filter-Change protects users from exposure to hazardous dust when changing filters
- Self closing vacuum port prevents hazardous dust from escaping when not in use
- Low profile design won't tip
- Lightweight aluminum chassis
- Heavy duty dual electric motors
- ULPA Filter is 99.9995% efficient @ 0.12 µm (U15)
- Each vacuum certified leak free
- Pre-filter protects ULPA filter for longer life
- Includes all filters and bags

Consolidated Hose Reel & Toolkit	Cyclone
ULPA Vacs	

DustMaster Electric Vacuum

Model	NSN	Power	Weight lbs (kg)	Dimensions Inches (cm)	Consumption	CFM (lpm)	Vacuum "H2O (mbar)	dBA	HP	Price
DM-100	7910-01-520-6439	Electric	84	28w x 22d x 20h (71w x 55d x 50h)	120VAC @ 20A	182 (5153)	85 (212)	77	2	

★ Available on GSA Advantage website @ www.GSAadvantage.gov
 ⓘ Hoses sold separately

DustMaster Pneumatic Vacuums

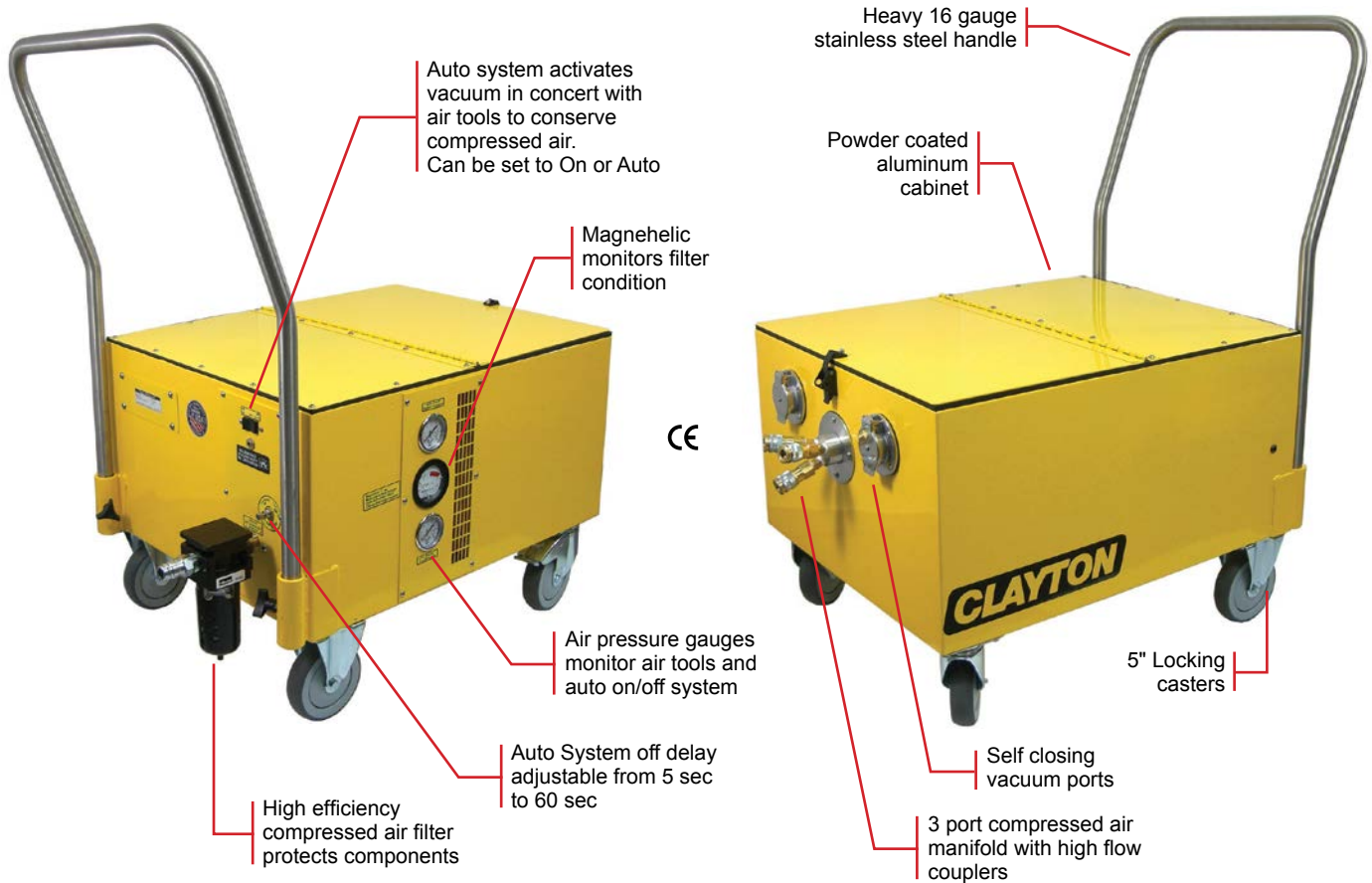

Features

- Supports up to 3 users
- Auto On/Off System turns vacuum on when pneumatic tool is actuated (user adjustable)
- Uses a single compressed air line and an internal manifold to supply 3 users with compressed air
- Safe-Filter-Change protects users from exposure to hazardous dust when changing filters
- Self closing vacuum port prevents hazardous dust from escaping when not in use
- Low profile design won't tip
- Lightweight aluminum chassis
- Heavy duty dual pneumatic motors
- ULPA Filter is 99.9995% efficient @ 0.12 µm (U15)
- Pre-filter protects ULPA filter for longer life
- Includes all filters and bags

Consolidated Hose Reel & Toolkit	Cyclone
ULPA Vacs	

DustMaster Pneumatic Vacuum

Model	NSN	Power	Weight lbs (kg)	Dimensions Inches (cm)	Consumption	CFM (lpm)	Vacuum "H2O (mbar)	dBA	HP	Price
DM-104	7910-01-520-6436	Pneumatic	77	28w x 22d x 20h (71w x 55d x 50h)	75 CFM @ 90 PSI (2123 lpm @ 621kPa)	212 (6003)	125 (310)	75	-	

* CFM with cyclone pre separator

★ Available on GSA Advantage website @ www.GSAadvantage.gov
 ⓘ Hoses sold separately

DustMaster Consolidated Tool Kit & Hose Reel

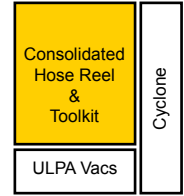

The Consolidated Tool Kit & Hose Reel provides storage for three vacuum hoses. The top of the CTK is a shadowboxed tool tray which holds sanders and tools. Every item is tethered or shadowed, so tool control can be easily maintained. Each compartment is lockable for tool security.

The CTK is available with wheels as a standalone unit or without wheels for mounting on a Clayton DustMaster Vacuum.

Includes:

- All steel powder coated construction
- Heavy duty tie down rings
- Foldable hose reel crank handle
- Heavy duty lift handles
- Gas springs hold lid open
- Large 5" locking casters on 650-301
- Lockable hasps
- Three position hose reel
- Two color shadow box foam

Hose reel provides storage for up to three 30' combination air/vacuum hoses.

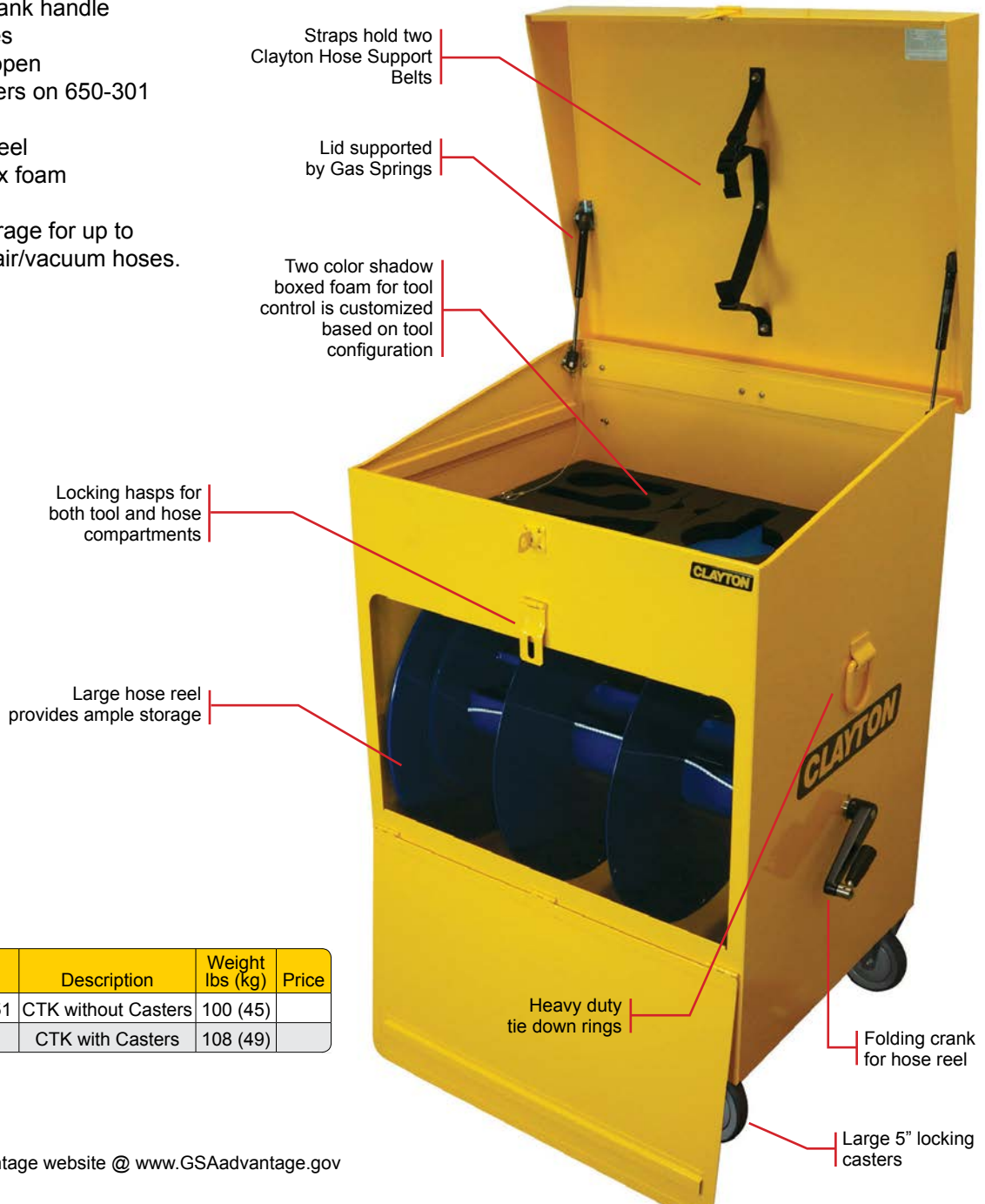

CTK Only

Model	NSN	Description	Weight lbs (kg)	Price
650-201	5140-01-520-8551	CTK without Casters	100 (45)	
650-301		CTK with Casters	108 (49)	

★ Available on GSA Advantage website @ www.GSAadvantage.gov
 ⓘ Hoses sold separately



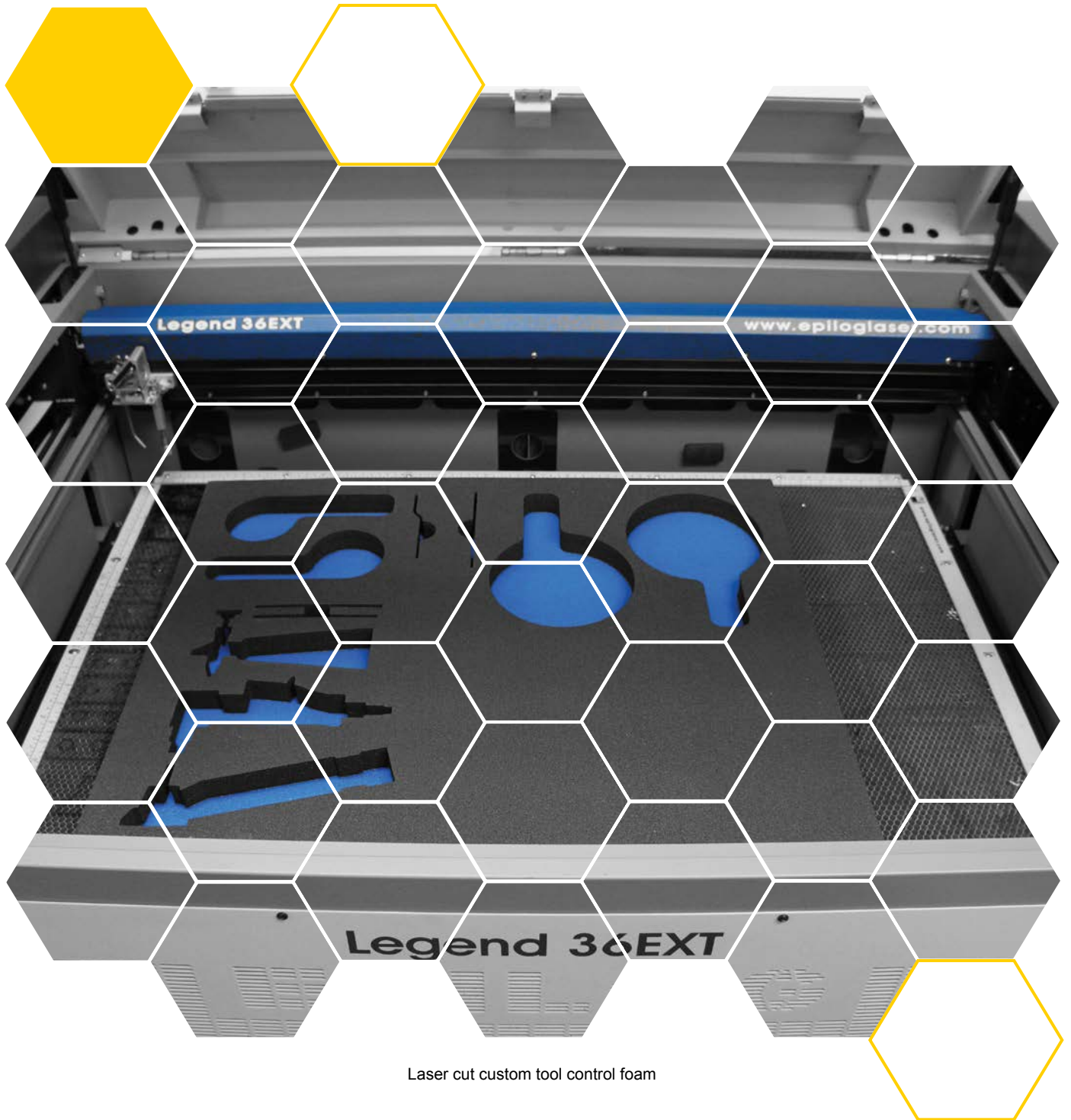

Laser cut custom tool control foam

DustMaster CTK Systems

The DustMaster CTK Systems combine a DustMaster Electric or Pneumatic vacuum with a CTK to form a single self contained portable unit with space for hoses tools and abrasives in a single place. This makes deployment and storage a one man job.

Features

- Supports up to 3 users
- Use a single compressed air line and an internal manifold to supply 3 users with compressed air
- Self closing vacuum port prevents hazardous dust from escaping when not in use
- Heavy duty dual motors
- ULPA Filter is 99.9995% efficient @ 0.12 µm (U15)
- Pre-filter protects ULPA filter for longer life
- Includes all filters and bags for turnkey operation

Consolidated Hose Reel & Toolkit	Cyclone
HEPA Vac	



DustMaster Systems (CTK)

Model	NSN	Power	Dimensions Inches (cm)	Weight lbs (kg)	Price
DM-100CTK		Electric	28w x 22d x 53h	184 (83)	
DM-104CTK		Pneumatic	(71w x 55d x 134h)	177 (80)	

DustMaster CTK / Cyclone Systems

The DustMaster CTK Cyclone systems, in either Electric or Air Powered, include the addition of our Cyclonic separator that captures 99% of debris before it gets to the primary filter bag. This means fewer filter changes and less loss of suction. The cyclone is only available with the CTK.

Features

- Use a single compressed air line and the internal manifold to supply 3 users with compressed air
- Supports up to 3 users
- Self closing vacuum port prevents hazardous dust from escaping when not in use
- Heavy duty dual motors
- ULPA Filter is 99.9995% efficient @ 0.12 µm (U15)
- Pre-filter protects ULPA filter for longer life
- Includes all filters and bags for turnkey operation

Consolidated Hose Reel & Toolkit	Cyclone
HEPA Vac	



DustMaster Systems (CTK)

Model	NSN	Power	Dimensions Inches (cm)	Weight lbs (kg)	Price
DM-300		Electric	36w x 22d x 53h	207 (93)	
DM-304		Pneumatic	(91w x 55d x 134h)	200 (90)	

* Available on GSA Advantage website @ www.GSAadvantage.gov



Call 732-363-2100 / 800 248-8650 or Order 24 hours a day from our website @ www.JClayton.com



The DustMaster Turn-Key Kits

This turn-key kit includes tools, hose, and abrasives.

660-DM-1000-4 (pneumatic) / 660-DM-1000-0 (electric)

This DustMaster System is ideal for maintenance on both airframes and ground support equipment. A core set of tools provides flexibility to tackle larger surfaces like the wing or fuselage, or tighter areas and curves, like rotor blades or munitions. Multiple hoses and tools allow up to three artisans to work simultaneously

- DustMaster ULPA Vacuum with patented Safe-Filter-Change.
- Consolidated Tool Kit (CTK) with shadow-boxed two-color foam
- One 2" Grinder kit with abrasives and accessories
- Two 3" Random Orbital Sanders, backup pads, protector pads, & 750 sheets of 3" abrasive
- Two 6" Random Orbital Sanders, backup pads, protector pads, and 750 sheets of 6" abrasive
- Two 20' Air/Vac work hoses, One 30' Air/Vac work hose
- One Compressed air supply line, and a complement of fittings

DustMaster Turn-Key Kits

Model	NSN	Power	Price
660-DM-1000-4	5130-01-413-9122	Pneumatic	
660-DM-1000-0		Electric	

670-DM-1535-4 (pneumatic) / 670-DM-1535-0 (electric)

This DustMaster System contains a robust set of tools selected by NAVAIR maintainers to support all types of aviation assets during long deployments. Multiple hoses and tools allow up to three artisans to work simultaneously.

- DustMaster ULPA Vacuum with patented Safe-Filter-Change.
- Consolidated Tool Kit (CTK) with shadow-boxed two-color foam
- Two 3" Random Orbital Sanders, backup pads, protector pads, and 1000 sheets of 3" abrasive
- One 3x4" Orbital Sander, backup pads, and 500 sheets of 3x4" abrasive
- One 3-2/3 x 7" Orbital Sander, backup pads, and 500 sheets of 3-2/3 x 7" abrasive
- Two 6" Random Orbital Sanders, backup pads, protector pads, and 1000 sheets of 6" abrasive
- Two 20' Air/Vac work hoses, One 30' Air/Vac work hose, Two Hose support belts
- One Compressed air supply line, and a complement of fittings
- Complement of Filter bags, Pre-filters, and Waste disposal bags

DustMaster Turn-Key Kits

Model	NSN	Power	Price
670-DM-1535-4	7910-01-653-4892	Pneumatic	
670-DM-1535-0	5130-01-551-2270	Electric	

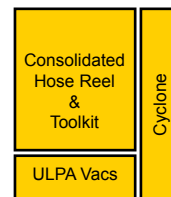

* Available on GSA Advantage website @ www.GSAadvantage.gov

This turn-key kit includes tools, hose, and abrasives.

660-DM-500-4 (pneumatic) / 660-DM-500-0 (electric)

This DustMaster System is ideal for maintenance on both airframes and ground support equipment. A core set of tools provides flexibility to tackle larger surfaces like the wing or fuselage, or tighter areas and curves, like rotor blades or munitions. Multiple hoses and tools allow 2 artisans to work simultaneously. Add a third vacuum hose to support three users.

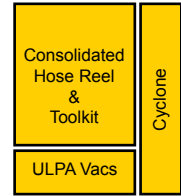

- DustMaster ULPA Vacuum with patented Safe-Filter-Change.
- Consolidated Tool Kit (CTK) with shadow-boxed two-color foam
- One 2" Grinder kit with abrasives and accessories
- Two 3.5" Random Orbital Sanders, backup pads, protector pads, & 200 sheets of 3.5" abrasive
- Two 5" Random Orbital Sanders, backup pads, protector pads, and 200 sheets of 5" abrasive
- Two 20' Air/Vac work hoses
- One Compressed air supply line, and a complement of fittings

DustMaster Turn-Key Kits

Model	NSN	Power	Price
660-DM-500-4	4130-01-532-9524	Pneumatic	
660-DM-500-0		Electric	



Please call for other Tool & Shroud combinations that may be available.

* Available on GSA Advantage website @ www.GSAadvantage.gov

DustMaster Accessories

Covers

This black nylon cover will keep your DustMaster looking like new.

- Dual ply 420 Denier Nylon with water proof urethane backing
- Cover is sized so that it will not drag on the ground
- Handle slots expose handle for easy movement
- Waterproof



DustMaster System Covers

Model	NSN	Description	Price
954-006		System cover for CTK system	
954-005		System cover for CTK Cyclone system	

Cyclone Add On

Our Cyclonic pre-separator is an add-on unit that captures 99% of debris before it gets to the primary filter bag. This means fewer filter changes and less loss of suction.

- Kit includes all mounting hardware

Cyclone Add-On

Model	NSN	Power	Weight lbs (kg)	Price
682-A102		Cyclone Add on Kit	40 (19)	



DustMaster Filters

Clayton ULPA are engineered to provide maximum protection from hazardous dust. ULPA Filter is 99.9995% efficient @ 0.12 µm (U15). These filters are the ideal solution when working with chromated primers, lead paints, or composites.

Clayton Pre-filters have been designed to prolong the life of the ULPA filter. Pre-filters provide protection from larger particles which might escape when a bag filter is installed incorrectly or has sustained damage.

Disposable bag filters are the first stage of filtration on most Clayton vacuums. These vacuum bags are designed to capture larger particles and debris. Most are manufactured with a lining to resist 'caking' of dust on the inside of the bag. Bag filters are intended for single use.

DustMaster Bags & Filters

Model	NSN	Description	Price
600-313A	7910-01-520-6435	Bag Filter 5 pack (DM Vac)	
610-313A	4310-01-520-8595	Collection Bag Cloth 10 pack (Cyclone)	
600-115	4310-01-519-5205	Pre-filter 3 pack	
600-116	4310-01-519-5796	ULPA Filter 1 pack	
600-114DM	8105-01-521-2119	Black 6 mil poly bag 25 pack	
926-75F		Compressed Air Filter 40	
926-75F-01		Replacement Filter Element 40µm	



600-115

600-116

926-75F



600-114DM



610-313A



600-313A

Hippo Reversible Liquid Drum Vac



The heart of the system is our stainless steel air powered reversible drum pump. Pair it with any 5, 30, 55, or 110 gallon closed head drum to create a high powered drum vac for picking up floor spills or transferring liquids.

Our flow thru pump has no moving parts and can fill or empty a 55 gallon drum in less than 2 minutes. It's great for recovery of hydraulic oils, coolants, and other non combustible fluids.

Hippo Drum Vac Includes:

- Stainless Steel Drum Pump
- Riser Assembly
- 1-1/2" x 90° quick disconnect coupler

Hippo Drum Vac Kits Include:

- Hippo Drum Vac
- 1-1/2" Vacuum Hose
- 2 Piece Wand, Squeegee Floor Tool, and Crevice Tool

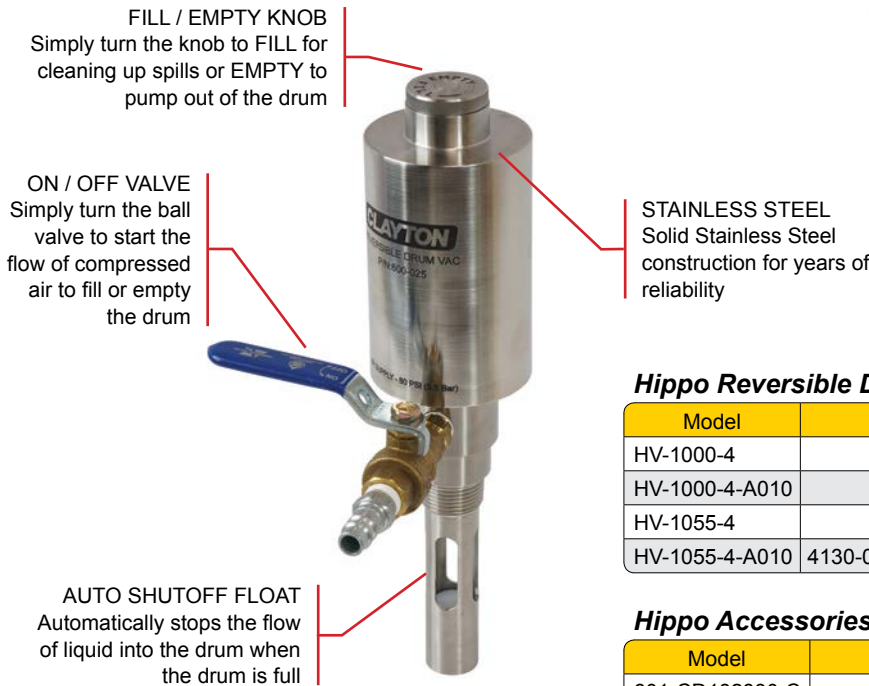

Hippo Reversible Drum Pump

Model	NSN	Description	Price
HV-1000-4		Hippo Drum Vac (No Drum)	
HV-1000-4-A010		Hippo Drum Vac Kit (No Drum)	
HV-1055-4		Hippo Drum Vac 55 Gallon	
HV-1055-4-A010	4130-01-526-4627	Hippo Drum Vac Kit 55 Gallon	

Hippo Accessories

Model	NSN	Description	Price
601-CD182830-C		30 Gallon Closed Head Drum	
601-CD223455-C		55 Gallon Closed Head Drum	
610-8030		Drum Dolly 30 Gallon	
610-8055		Drum Dolly 55 Gallon	
671-VHL24-10		Vacuum Hose 10 ft	
671-VHL24-20		Vacuum Hose 20 ft	
630-A010		Cleanup Toolkit for Wet Pickup	



1-1/2" x 20' hose



Cleanup Toolkit for Wet Pickup includes a tool control belt (not shown)



Pump, Riser, and Coupler

HEPA Grinding Station

Stand at this HEPA filtered grinding station to work on small parts without source capture vacuum tools. 1350 CFM and a face velocity of 450 ft/min entrain dust and a three stage filtration system captures it. Safe Filter Change allows users to change stage 1 & 2 panel filters without exposure to hazardous dust.

Features:

- Three Stage Filtration
- Stage 1 MERV 8 Primary Panel Filter
- Stage 2 MERV 13 Secondary Panel Filter
- Stage 3 HEPA Cartridges filter 99.97% of particles down to 0.3 µm
- Differential pressure gauges monitor filters
- Large work area 31w x 12d x 13h
- Overall 32w x 37d x 50h x 300 lbs
- Requires 120V 20A circuit

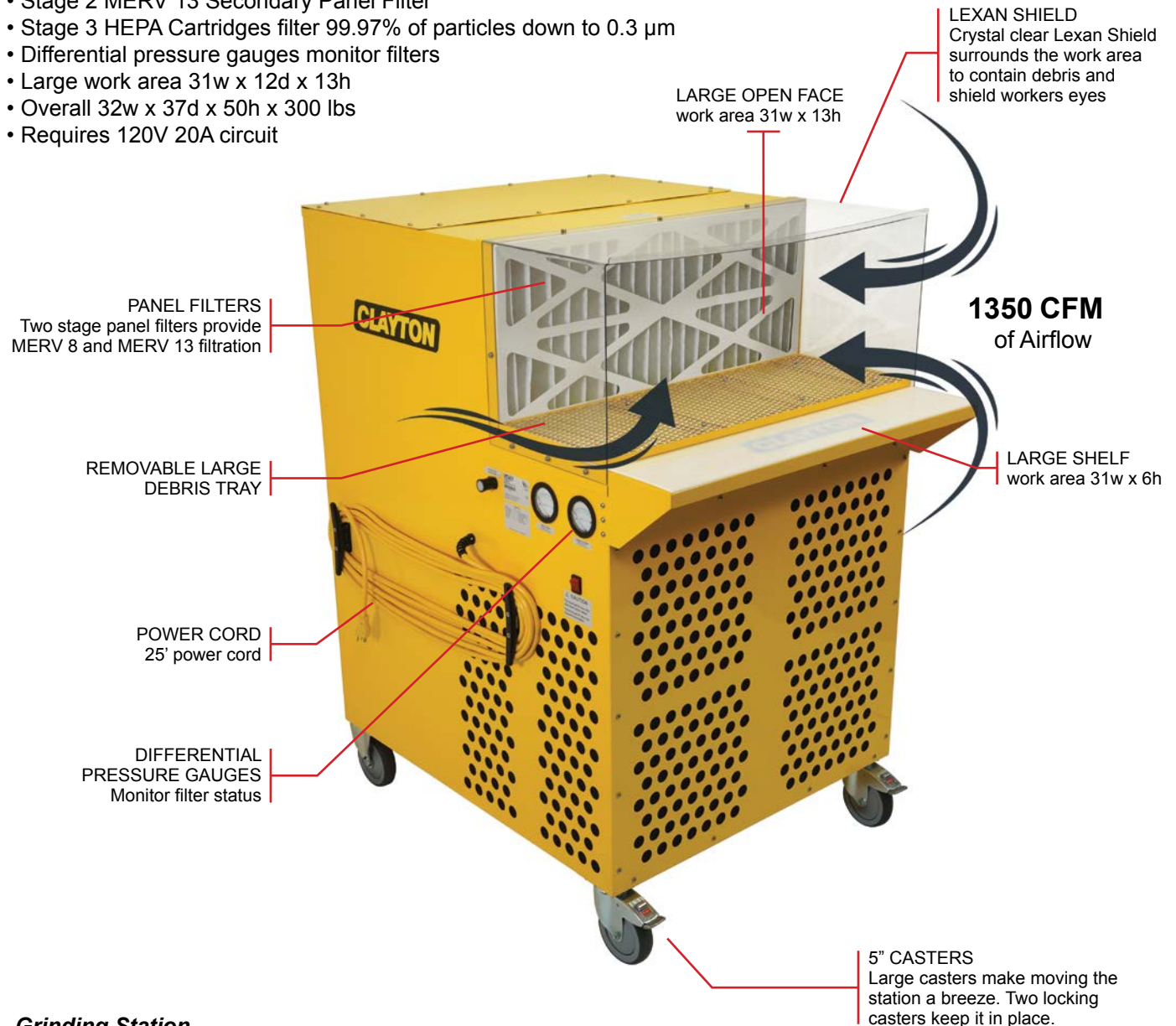

Grinding Station

Model	NSN	Description	Price
GS-1350-01	4130-01-460-7698	Grinding Station 1350 CFM	
627-1350PM08		Panel Filter 30in x 13in MERV 8	
627-1350PM13		Panel Filter 30in x 13in MERV 13	
627-1350H		HEPA Filter 14in x 30in (2 required)	
610-202G		Replacement Lexan Shield	

Clayton Tent & Vent Overspray Filtration System Paint Anywhere, Any Shift! - NESHAP 98 - 3 Stage Method 319 Compliant



The Clayton Tent & Vent is designed to allow aircraft painting on the hangar floor without exposing workers to overspray and VOCs. The TV-1400 enables a better paint application with less rework, as it removes and filters overspray paint particulate which can often dry in the air and contaminate the fresh paint job.

Systems designed for the removal of airborne paint particulate, especially those containing chromates, must adhere to NESHAP 98 Test Method 319 for Aerospace painting and de-painting operations. The TV-1400 meets all standards for the safe evacuation and filtration of chromated primers and other coatings.

After the work area is masked with a poly tent, the TV-1400 is connected to compressed air. It maintains the tented area under negative pressure, rapidly turning over the air within, while three wet particulate filters collect overspray and a 24" charcoal filter absorbs VOCs returning clean odor free exhaust air back into the hangar. The TV-1400 exhaust can be connected to optional flex ducting to route the clean air to the outside.

- Exceeds the requirements of 40 CFR 63
- 1200 cfm of air flow easily evacuates 12x10x10 painting tents
- Includes 18" inlet extension and 12" muffler
- Air powered – requires 60cfm of compressed air @ 90psi
- 48w x 24d x 48h

All Tent components are included in Kit 1 and Kit 2



Protect the floor and mask aircraft with rosin paper.



Build your tent with poly sheeting. Include inlets for make up air.



Attach Tent & Vent Filtration System to tent, then add tubing to reroute exhaust if desired.



Run the filtration system during painting and curing.

Clayton Tent & Vent Overspray Filtration System



Tent & Vent Filtration

Model	NSN	Description	Price
TV-1400		Tent-N-Vent Paint Tent Filtration System	
TV-1400-KIT1	4130-01-503-9364	Tent & Vent plus Consumables	
TV-1400-KIT2	4130-01-460-8189	Consumable Replenishment Kit Only	

Tent & Vent Accessories

Model	Description	Price
627-242401-PM08	Panel Filter 24x24 Merv8 (10pk)	
627-242401-PN99	Panel Filter 24x24 NESHAP 99 (10pk)	
627-242415-PM14	Multi-Pocket Filter 24x24x15 (5pk)	
627-242404PC-02	Carbon Filter 24x24x4 (2pk)	



Duct Extension Kit

Painting areas not at floor level like vertical stabilizers, may require sections of flexible 8" conductive ducting. Each section is 15' long and designed to connect directly to the Tent & Vent intake. An available cart holds ducting for transport and storage.

Tent & Vent Add Ons

Model	NSN	Description	Price
671-VHD80-15		Flexible Ducting Inlet Extension 15ft	
955-TVC5225		Ducting Storage Cart Only	



MOBILE PAINT BOOTH

The Clayton Mobile Paint Booth is a portable inflatable enclosure that allows painting almost anywhere. The booth evacuates overspray and keeps the inside of the booth free of airborne particulate. Each unit has a wide entrance, allowing easy access with large parts or rolling carts. The clear side panels provide plenty of light to illuminate the work area. The entire booth, powered by 120V portable blowers, inflates in under 2 minutes. Deflated, it fits on a pallet.

Each kit includes: Inflatable Booth, Pump, Blower and storage crate.

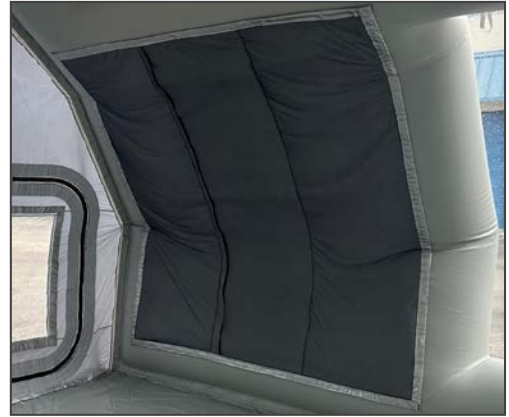

Neshap Filter / Carbon Filter Panels discharge clean filtered air

Mobile Paint Booth

Model	NSN	Description	Price
CC-PB151510-01	4130-01-458-8667	Mobile Paint Booth 15x15x9	
CC-PB402312-01	4130-01-458-8670	Mobile Paint Booth 40x23x12	



Filtered air enters booth at the rear



**Contaminated air exits through side filters
Main Entry unzips for large vehicle access**



**23ft x 40ft Booth
6 side windows and front entry windows let in plenty of light.**

HELI-CELL

HUMIDITY CONTROLLED ENVIRONMENTS

The Heli-Cell provides a controlled environment for storage of rotary wing aircraft and similarly sized assets. It maintains 40% or lower relative humidity, dramatically reducing corrosion and preserving the critical components and electronics. Assets stored in the Heli-Cell remain dust-free, clean and in the condition they were left. The Heli-Cell also reduces and defers maintenance and related costs by freezing calendar items and Due List requirements.

Multiple sizes available to suit your airframe.



Maneuver asset onto floor panel, then pull cover up and over vehicle

Heli-Cell Booth

Model	NSN	Description	Price
C3-HE-154015		Heli-Cell 40ft	
C3-HE-156015		Heli-Cell 60ft	



Once covered, seal the edges



Activate fan motors to inflate the structure



Service Offerings

Clayton systems are designed with a core focus on safety and health, and it is important to keep the vacuums, tools, and accessories in proper condition to ensure that the system can continue to protect workers and the environment. Clayton offers a variety of service contracts and maintenance plans to meet the requirements of most organizations. These services are intended to make it simple for customers to keep their tools and equipment running in accordance with factory performance specifications.

Return-to-Factory Service

Clayton maintains a repair and refurb center in our NJ factory. Technicians are trained in the remanufacture of vacuums, tools, and accessories. Customers can ship in products that are damaged, worn, or underperforming, and our team will rebuild them and return them to factory performance specifications. Customers can opt to have older equipment upgraded at the same time. Products that cannot be repaired may be returned to the customer or held at Clayton in exchange for a credit towards new tools or equipment.

On-Site Service

Clayton factory trained technicians can provide on-site service for our products. On-site service can take many forms, depending on your organization's needs. Clayton can provide a full time technician to maintain vacuums, performing all maintenance tasks from filter bag changes to major repairs. e can also provide monthly, quarterly, or yearly service visits to change HEPA filters, run performance tests on vacuums, and handle on-site repairs of wear items. On-Site service plans are custom designed around the specific customer, and take into account the number of vacuums, the level of service required, and other customer-centric variables.

Training

Clayton systems are very effective at reducing exposure and safely containing hazardous dust. Proper use and care of the tools and vacuums is essential to getting maximum performance. Clayton representatives are available for on-site training sessions with individuals or groups. We can provide training on equipment, tool usage, tool repair, or vacuum maintenance. Many customers find it beneficial to have annual or bi-annual re-training of employees.

SANDERS

Random Orbital • Orbital • Specialty • Hand Sanders



CHOOSE YOUR WEAPON



AeroLite

Pneumatic Sanders

- Composite Housing
- Light weight Design
- Available in DA & Orbital
- Central Vac
- Self Generated Vac
- Non-Vac



ErgoLite

Pneumatic Sanders

- Advanced Composite Housing
- Ergonomic Design
- Available in DA
- Central Vac
- Self Generated Vac
- Non-Vac



DuraLite

Pneumatic Sanders

- Aluminum Housing
- Lower Vibration
- Available in DA & Orbital
- Central Vac
- Self Generated Vac
- Non-Vac



ElectroLite

Electric Sanders

- Central Vac
- Non-Vac



AeroLite Two Hand

High Torque Sanders

- Available in DA Only
- Central Vac
- Self Generated Vac
- Non-Vac

ERGOLITE



Next Generation Palm Sanders

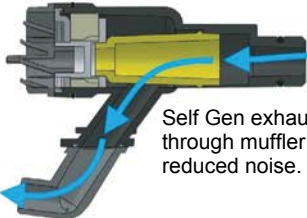

Self Gen exhaust flows through muffler for reduced noise.

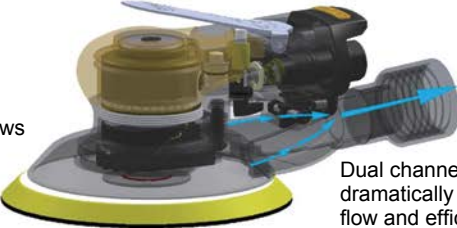

Dual channel vacuum design dramatically increases vacuum flow and efficiency.



Fan Blade cooling system lowers bearing temperature for increased life.

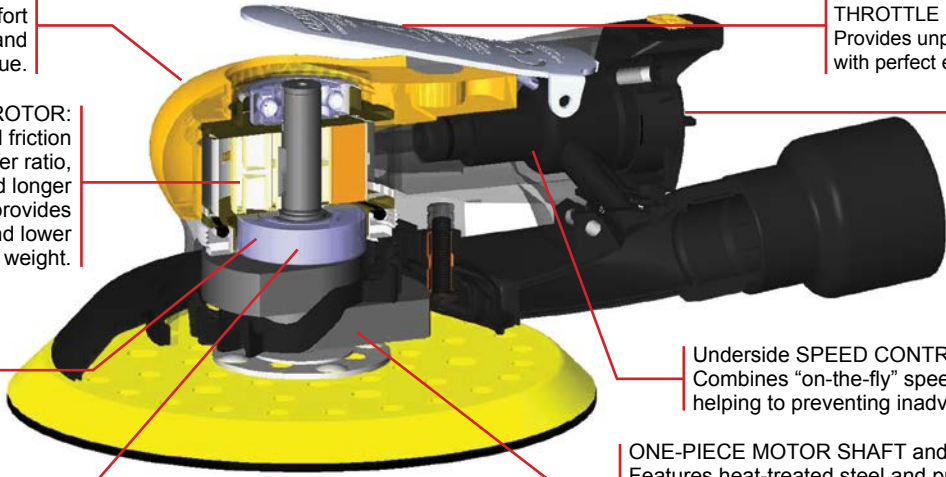

COMFORT GRIP:
Vibration absorbing Comfort Grip improves feel and reduces hand fatigue.

CURVED ALLOY STEEL THROTTLE LEVEL:
Provides unparalleled durability with perfect ergonomics.

FULL FLOATING ROTOR:
Designed to reduce internal friction for a higher power transfer ratio, simplified maintenance, and longer tool life. Polymer rotor provides faster acceleration and lower overall tool weight.

DIRECTIONAL EXHAUST:
360° user Rotation on compressed air exhaust vent.

BEARING PROTECTION SYSTEM:
Allows one way filtered airflow to pass into spindle bearing chamber. Cooler running, dust free bearings mean longer bearing life.

Underside SPEED CONTROL:
Combines "on-the-fly" speed adjustment while helping to preventing inadvertent switching.

RUGGED BEARING:
Provides for longer tool life.

ONE-PIECE MOTOR SHAFT and PAD BALANCER:
Features heat-treated steel and precision machined construction for smooth and durable operation.

ERGOLITE

COMPOSITE HOUSING

Central Vac DA (Dual Action / Random Orbital)

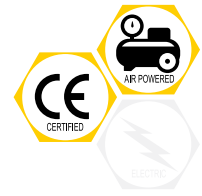

- **Central Vac** sanders require a portable or central vacuum for dust extraction. They come standard with a 1in threaded vacuum port for attachment to any Clayton vacuum system.
- **Random Orbital (RO)** or **Dual Action (DA)** sanders simultaneously spin the sanding disk and move in an ellipse. This unique random sanding action eliminates swirl marks in your work. They are available in 2 sizes and 3 orbits.

Sander Features

- J-Hook backup pad for hook & loop abrasives
- Vacuum hose swivel adapter 1in
- Ergonomic Wrist support
- 1/4" (6.4mm) Air inlet
- Consumes 17 cfm (481 lpm)
- Produces 12,000 rpm & .28 hp (209 w)

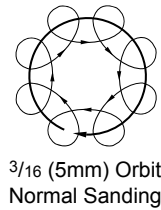
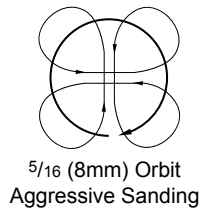

🔊 Don't forget our interface and protector pads to extend the life of your backup pad!

DA Sanders - CV

Model	Pad Size	NSN	Orbit inch (mm)	Sound dBA	Weight lbs (kg)	Price
770-12311J	3" (76mm)		3/32 (2)	74	1.7 (0.76)	
770-12301J	3" (76mm)		3/16 (5)	74	1.7 (0.79)	
770-12511J	5" (125mm)		3/32 (2)	74	1.7 (0.77)	
770-12501J	5" (125mm)	4130-01-504-3970	3/16 (5)	74	1.8 (0.79)	
770-12521J	5" (125mm)	4130-01-460-4055	5/16 (8)	74	1.8 (0.82)	
770-12611J	6" (150mm)		3/32 (2)	74	1.8 (0.82)	
770-12601J	6" (150mm)	4130-01-517-1019	3/16 (5)	74	1.9 (0.85)	
770-12621J	6" (150mm)	4130-01-460-4052	5/16 (8)	74	1.9 (0.88)	

* Replace J with S for Vinyl Pad on all models



① All tool performance ratings measured @ 90 PSI (620 kPa) compressed air pressure.
 ★ Available on GSA Advantage website @ www.GSAadvantage.gov

ERGOLITE

COMPOSITE HOUSING

Central Vac Orbital



- **Central Vac** sanders require a portable or central vacuum for dust extraction. They come standard with a 1in threaded vacuum port for attachment to any Clayton vacuum system.
- **Orbital or Jitter** sanders move front to back and side to side simultaneously. They are typically used for fine finish sanding or getting into square corners. They are available in 7 sizes, all 1/8in orbit.

Sander Features

- J-Hook backup pad for hook & loop abrasives
- Vacuum hose swivel adapter 1in
- Ergonomic Wrist support
- 1/4" (6.4mm) Air inlet
- Consumes 17 cfm (481 lpm)
- Produces 12,000 rpm & .28 hp (209 w)



1/8 (3.2mm) Orbit
Finish Sanding

Orbital Sanders - CV

Model	Pad Size	NSN	Sound dBA	Weight lbs (kg)	Price
770-10341J*	3 x 4" (75 x 100mm)			1.8 (0.81)	
770-10281J*	2-3/4 x 8" (70 x 200mm)			2.2 (1)	
770-10341J-56R	Radius 3 x 5" (75 x 127mm)			1.8 (0.82)	
770-10341J-66R	Radius 3 x 5" (75 x 127mm)			1.8 (0.82)	

* Replace J with S for Vinyl Pad on select models



Large 1in Central Vac Port



2-3/4x8in



3x4in



Radius 56R



Radius 66R

① All tool performance ratings measured @ 90 PSI (620 kPa) compressed air pressure.
 ★ Available on GSA Advantage website @ www.GSAadvantage.gov

ERGOLITE

COMPOSITE HOUSING

Self Generated Vac DA (Dual Action / Random Orbital)



- **Self Generated Vac** sanders use the sanders compressed air exhaust to generate their own vacuum for dust extraction. They come standard with a 1in threaded vacuum port. Bag & 1in Bag Adapter Sold Separately.
- **Random Orbital (RO) or Dual Action (DA)** sanders simultaneously spin the sanding disk and move in an ellipse. This unique random sanding action eliminates swirl marks in your work. They are available in 2 sizes and 3 orbits.
- **Lubricant Contamination** on sensitive parts can be eliminated by using a Central Vac with any SGV Sander instead of a Bag, since all compressed air is diverted into the Vac Hose.

Sander Features

- J-Hook backup pad for hook & loop abrasives
- Bag swivel adapter 1in
- Ergonomic Wrist support
- ¼" (6.4mm) Air inlet
- Consumes 17 cfm (481 lpm)
- Produces 12,000 rpm & .28 hp (209 w)

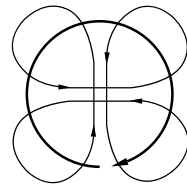

5/16 (8mm) Orbit
Aggressive Sanding

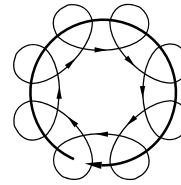

3/16 (5mm) Orbit
Normal Sanding

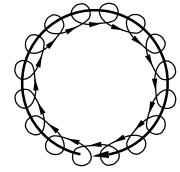

3/32 (2.5mm) Orbit
Finish Sanding

🔊 Don't forget our interface and protector pads to extend the life of your backup pad!

DA Sanders - Self Gen

Model	Pad Size	NSN	Orbit inch (mm)	Sound dBA	Weight lbs (kg)	Price
770-12313J	3" (76mm)		3/32 (2)	87	1.7 (0.76)	
770-12303J	3" (76mm)		3/16 (5)	87	1.7 (0.79)	
770-12513J	5" (125mm)		3/32 (2)	87	1.7 (0.77)	
770-12503J	5" (125mm)		3/16 (5)	87	1.8 (0.79)	
770-12523J	5" (125mm)		5/16 (8)	87	1.8 (0.82)	
770-12613J	6" (150mm)		3/32 (2)	87	1.8 (0.82)	
770-12603J	6" (150mm)		3/16 (5)	87	1.9 (0.85)	
770-12623J	6" (150mm)		5/16 (8)	87	1.9 (0.88)	

* Replace J with S for Vinyl Pad on all models

Self Gen Sander Bags

Model	NSN	Description	Price
678-20453		3M Filter Bag Adapter	
678-20452		3M Clean Sanding Filter Bag 10 pk	
130123	4130-01-460-8514	3M Clean Sanding Filter Bag 100 pk	



3in



5in



6in

① All tool performance ratings measured @ 90 PSI (620 kPa) compressed air pressure.
 ★ Available on GSA Advantage website @ www.GSAadvantage.gov

ERGOLITE

COMPOSITE HOUSING

Self Generated Vac Orbital



- **Self Generated Vac** sanders use the sanders compressed air exhaust to generate their own vacuum for dust extraction. They come standard with a 1in threaded vacuum port. Bag & 1in Adapter Sold Separately.
- **Orbital** or **Jitter** sanders move front to back and side to side simultaneously. They are typically used for fine finish sanding or getting into square corners. They are available in 7 sizes, all 1/8in orbit.
- **Lubricant Contamination** on sensitive parts can be eliminated by using a Central Vac with any SGV Sander instead of a Bag, since all compressed air is diverted into the Vac Hose.

Sander Features

- J-Hook backup pad for hook & loop abrasives
- Bag swivel adapter 1in
- Ergonomic Wrist support
- 1/4" (6.4mm) Air inlet
- Consumes 17 cfm (481 lpm)
- Produces 10,000 rpm & .28 hp (209 w)

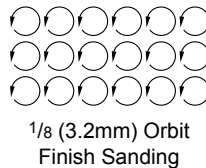

Large 1in SGV Bag Port

Orbital Sanders - Self Gen

Model	Pad Size	NSN	Sound dBA	Weight lbs (kg)	Price
770-10343J*	3 x 4" (75 x 100mm)			1.6 (0.73)	
770-10283J*	2-3/4 x 8" (70 x 200mm)			2.4 (1.07)	
770-10343J-56R	Radius 3 x 5" (75 x 127mm)			1.8 (0.73)	
770-10343J-66R	Radius 3 x 5" (75 x 127mm)			1.8 (0.73)	

* Replace J with S for Vinyl Pad on select models

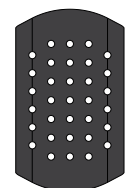
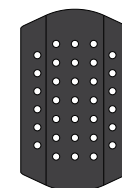
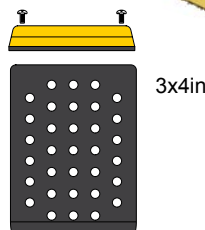
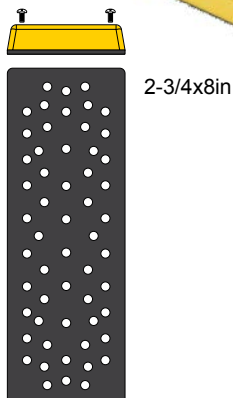

① All tool performance ratings measured @ 90 PSI (620 kPa) compressed air pressure.
 ★ Available on GSA Advantage website @ www.GSAadvantage.gov

ERGOLITE

COMPOSITE HOUSING

Non Vac DA (Dual Action / Random Orbital)



- **Random Orbital (RO) or Dual Action (DA)** sanders simultaneously spin the sanding disk and move in an ellipse. This unique random sanding action eliminates swirl marks in your work. They are available in 2 sizes and 3 orbits.

Sander Features

- J-Hook backup pad for hook & loop abrasives
- Ergonomic Wrist support
- 1/4" (6.4mm) Air inlet
- Consumes 17 cfm (481 lpm)
- Produces 12,000 rpm & .28 hp (209 w)

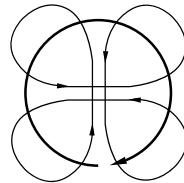

5/16 (8mm) Orbit
Aggressive Sanding

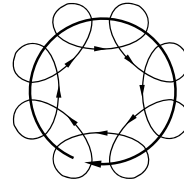

3/16 (5mm) Orbit
Normal Sanding

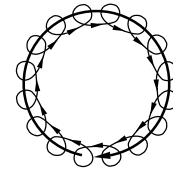

3/32 (2.5mm) Orbit
Finish Sanding

🔊 Don't forget our interface and protector pads to extend the life of your backup pad!

DA Sanders - Non Vac

Model	Pad Size	NSN	Orbit inch (mm)	Sound dBA	Weight lbs (kg)	Price
770-12310J	3" (76mm)		3/32 (2)	74	1.7 (0.76)	
770-12300J	3" (76mm)		3/16 (5)	74	1.7 (0.79)	
770-12510J	5" (125mm)		3/32 (2)	74	1.7 (0.77)	
770-12500J	5" (125mm)		3/16 (5)	74	1.8 (0.79)	
770-12520J	5" (125mm)		5/16 (8)	74	1.8 (0.82)	
770-12610J	6" (150mm)		3/32 (2)	74	1.8 (0.82)	
770-12600J	6" (150mm)		3/16 (5)	74	1.9 (0.85)	
770-12620J	6" (150mm)		5/16 (8)	74	1.9 (0.88)	



Air Tool Lubricant
00313
NSN: 4130-01-502-0850

* Replace J with S for Vinyl Pad on all models

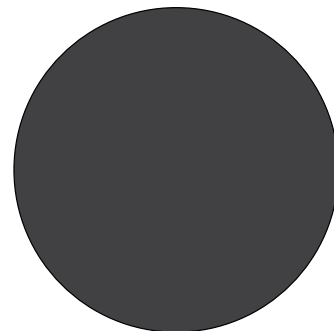
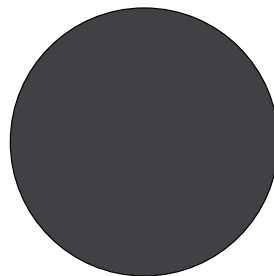
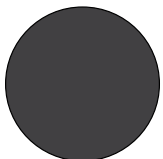

① All tool performance ratings measured @ 90 PSI (620 kPa) compressed air pressure.
 ★ Available on GSA Advantage website @ www.GSAadvantage.gov

ERGOLITE

COMPOSITE HOUSING

Non Vac Orbital



- **Central Vac** sanders require a portable or central vacuum for dust extraction. They come standard with a 1" threaded vacuum port for attachment to any Clayton vacuum system.
- **Orbital** or **Jitter** sanders move in an ellipse. They are typically used for fine finish sanding or getting into square corners. They are available in 3 sizes and 3 orbits.

Sander Features

- J-Hook backup pad for hook & loop abrasives
- Ergonomic Wrist support
- 1/4" (6.4mm) Air inlet
- Consumes 17 cfm (481 lpm)
- Produces 10,000 rpm & .28 hp (209 w)

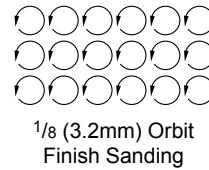

🔊 Don't forget our interface and protector pads to extend the life of your backup pad!

Orbital Sanders - Non Vac

Model	Pad Size	NSN	Sound dBA	Weight lbs (kg)	Price
770-10340J*	3 x 4" (75 x 100mm)			1.7 (0.75)	
770-10280J*	2-3/4 x 8" (70 x 200mm)			2.1 (0.95)	
770-10340J-56R	Radius 3 x 5" (75 x 127mm)			1.7 (0.77)	
770-10340J-66R	Radius 3 x 5" (75 x 127mm)			1.7 (0.77)	

* Replace J with S for Vinyl Pad on select models



Air Tool Lubricant
00313
NSN: 4130-01-502-0850



2-3/4x8in



3x4in



Radius 56R

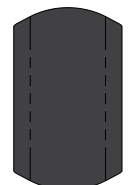

Radius 66R

① All tool performance ratings measured @ 90 PSI (620 kPa) compressed air pressure.
★ Available on GSA Advantage website @ www.GSAadvantage.gov

AEROLITE



Composite Housing Palm Sanders

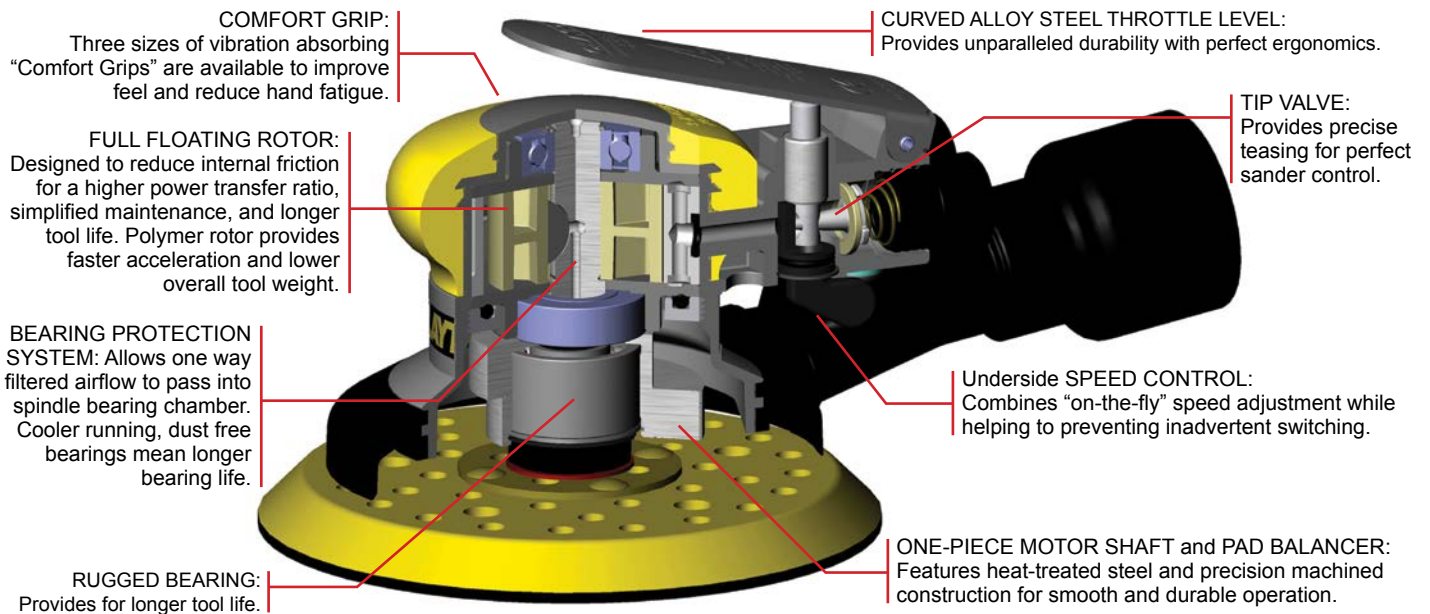

AEROLITE

COMPOSITE HOUSING

Central Vac DA (Dual Action / Random Orbital)

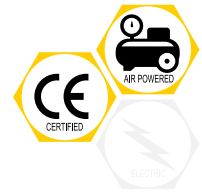

- **Central Vac** sanders require a portable or central vacuum for dust extraction. They come standard with a 1in threaded vacuum port for attachment to any Clayton vacuum system.
- **Random Orbital (RO) or Dual Action (DA)** sanders simultaneously spin the sanding disk and move in an ellipse. This unique random sanding action eliminates swirl marks in your work. They are available in 3 sizes and 3 orbits.

Sander Features

- J-Hook backup pad for hook & loop abrasives
- Vacuum hose swivel adapter 1in
- Ergonomic Wrist support
- ¼" (6.4mm) Air inlet
- Consumes 17 cfm (481 lpm)
- Produces 12,000 rpm & .28 hp (209 w)

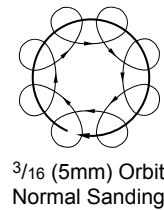
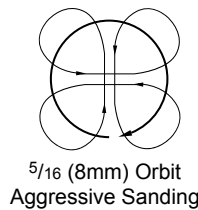

🔊 Don't forget our interface and protector pads to extend the life of your backup pad!

DA Sanders - CV

Model	Pad Size	NSN	Orbit inch (mm)	Sound dBA	Weight lbs (kg)	Price
675-12311J	3" (75mm)		3/32 (2)	72	1.5 (0.68)	
675-12301J	3" (75mm)	5130-01-520-5673	3/16 (5)	72	1.6 (0.7)	
670-12511J	5" (125mm)		3/32 (2)	74	1.7 (0.77)	
670-12501J	5" (125mm)		3/16 (5)	74	1.8 (0.79)	
670-12521J	5" (125mm)		5/16 (8)	74	1.8 (0.82)	
670-12611J	6" (150mm)		3/32 (2)	74	1.8 (0.82)	
670-12601J	6" (150mm)	5130-01-520-5669	3/16 (5)	74	1.9 (0.85)	
670-12621J	6" (150mm)		5/16 (8)	74	1.9 (0.88)	



Large 1in Central Vac Port

* Replace J with S for Vinyl Pad on all models

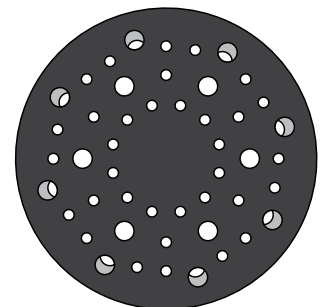
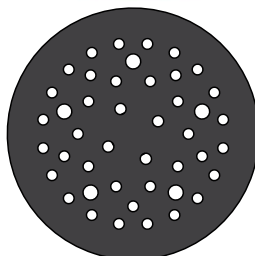
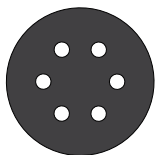

① All tool performance ratings measured @ 90 PSI (620 kPa) compressed air pressure.
 ★ Available on GSA Advantage website @ www.GSAadvantage.gov

AEROLITE

COMPOSITE HOUSING

Central Vac Orbital



- **Central Vac** sanders require a portable or central vacuum for dust extraction. They come standard with a 1in threaded vacuum port for attachment to any Clayton vacuum system.
- **Orbital** or **Jitter** sanders move front to back and side to side simultaneously. They are typically used for fine finish sanding or getting into square corners. They are available in 7 sizes, all 1/8in orbit.

Sander Features

- J-Hook backup pad for hook & loop abrasives
- Vacuum hose swivel adapter 1in
- Ergonomic Wrist support
- 1/4" (6.4mm) Air inlet
- Consumes 17 cfm (481 lpm)
- Produces 12,000 rpm & .28 hp (209 w)



1/8 (3.2mm) Orbit
Finish Sanding



Large 1in Central Vac Port

Orbital Sanders - CV

Model	Pad Size	NSN	Sound dBA	Weight lbs (kg)	Price
675-10341J*	3 x 4" (75 x 100mm)	5130-01-520-5670	71	1.6 (0.73)	
675-10341J-80D	Corner 3 x 4" (75 x 100mm)		71	1.6 (0.73)	
675-10351J*	3 x 5" (75 x 125mm)		77	2.4 (1.07)	
675-10281J*	2-3/4 x 8" (70 x 200mm)		77	2.4 (1.07)	
670-10371J*	3-2/3 x 7" (90 x 175mm)	5130-01-520-5672	77	2.4 (1.07)	
675-10341J-56R	Radius 3 x 5" (75 x 100mm)		77	1.6 (0.73)	
675-10341J-66R	Radius 3 x 5" (75 x 100mm)		77	1.6 (0.73)	

* Replace J with S for Vinyl Pad on select models

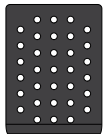

3x4in

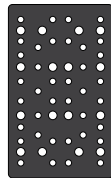

3x5in

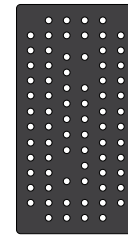

3-2/3x7in

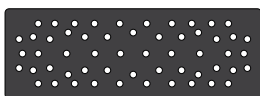

2-3/4x8in

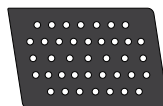

Corner

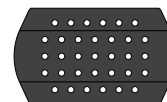

Radius 56R

① All tool performance ratings measured @ 90 PSI (620 kPa) compressed air pressure.
 ★ Available on GSA Advantage website @ www.GSAadvantage.gov

AEROLITE

COMPOSITE HOUSING

Self Generated Vac DA (Dual Action / Random Orbital)



- **Self Generated Vac** sanders use the sanders compressed air exhaust to generate their own vacuum for dust extraction. They come standard with a 1in threaded vacuum port. Bag & 1in Bag Adapter Sold Separately.
- **Random Orbital (RO) or Dual Action (DA)** sanders simultaneously spin the sanding disk and move in an ellipse. This unique random sanding action eliminates swirl marks in your work. They are available in 3 sizes and 3 orbits.
- **Lubricant Contamination** on sensitive parts can be eliminated by using a Central Vac with any SGV Sander instead of a Bag, since all compressed air is diverted into the Vac Hose.

Sander Features

- J-Hook backup pad for hook & loop abrasives
- Bag swivel adapter 1in
- Ergonomic Wrist support
- 1/4" (6.4mm) Air inlet
- Consumes 17 cfm (481 lpm)
- Produces 12,000 rpm & .28 hp (209 w)

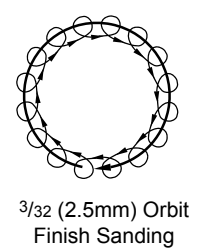
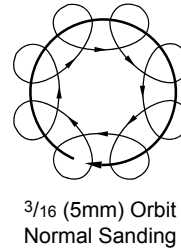
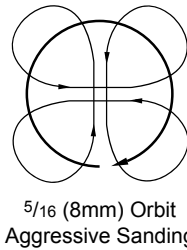

🔊 Don't forget our interface and protector pads to extend the life of your backup pad!

DA Sanders - Self Gen

Model	Pad Size	NSN	Orbit inch (mm)	Sound dBA	Weight lbs (kg)	Price
675-12313J	3" (75mm)		3/32 (2)	87	1.5 (0.68)	
675-12303J	3" (75mm)		3/16 (5)	87	1.6 (0.7)	
670-12513J	5" (125mm)		3/32 (2)	87	1.7 (0.77)	
670-12503J	5" (125mm)	5130-01-645-3399	3/16 (5)	87	1.8 (0.79)	
670-12523J	5" (125mm)		5/16 (8)	87	1.8 (0.82)	
670-12613J	6" (150mm)		3/32 (2)	87	1.8 (0.82)	
670-12603J	6" (150mm)		3/16 (5)	87	1.9 (0.85)	
670-12623J	6" (150mm)		5/16 (8)	87	1.9 (0.88)	

* Replace J with S for Vinyl Pad on all models



Self Gen Sander Bags

Model	NSN	Description	Price
678-20453		3M Filter Bag Adapter	
678-20452		3M Clean Sanding Filter Bag 10 pk	
130123	4130-01-460-8514	3M Clean Sanding Filter Bag 100 pk	
130043	4130-01-460-8507	5in SGV Sander & Filter Bag 50 pk	
130063	4130-01-460-8508	6in SGV Sander & Filter Bag 50 pk	



① All tool performance ratings measured @ 90 PSI (620 kPa) compressed air pressure.
 ★ Available on GSA Advantage website @ www.GSAadvantage.gov

AEROLITE

COMPOSITE HOUSING

Self Generated Vac Orbital

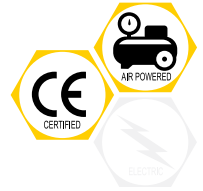

- **Self Generated Vac** sanders use the sanders compressed air exhaust to generate their own vacuum for dust extraction. They come standard with a 1in threaded vacuum port. Bag & 1in Adapter Sold Separately.
- **Orbital** or **Jitter** sanders move front to back and side to side simultaneously. They are typically used for fine finish sanding or getting into square corners. They are available in 7 sizes, all 1/8in orbit.
- **Lubricant Contamination** on sensitive parts can be eliminated by using a Central Vac with any SGV Sander instead of a Bag, since all compressed air is diverted into the Vac Hose.

Sander Features

- J-Hook backup pad for hook & loop abrasives
- Bag swivel adapter 1in
- Ergonomic Wrist support
- 1/4" (6.4mm) Air inlet
- Consumes 17 cfm (481 lpm)
- Produces 10,000 rpm & .28 hp (209 w)

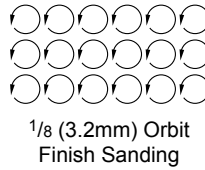

Orbital Sanders - Self Gen

Model	Pad Size	NSN	Sound dBA	Weight lbs (kg)	Price
675-10343J*	3 x 4" (75 x 100mm)		83	1.6 (0.73)	
675-10343J-80D	Corner 3 x 4" (75 x 100mm)		83	1.6 (0.73)	
675-10353J*	3 x 5" (75 x 125mm)		91	2.4 (1.07)	
675-10283J*	2-3/4 x 8" (70 x 200mm)		91	2.4 (1.07)	
670-10373J*	3-2/3 x 7" (90 x 175mm)		91	2.4 (1.07)	
675-10343J-56R	Radius 3 x 5" (75 x 100mm)		83	1.6 (0.73)	
675-10343J-66R	Radius 3 x 5" (75 x 100mm)		83	1.6 (0.73)	



Large 1in SGV Bag Port

* Replace J with S for Vinyl Pad on select models



① All tool performance ratings measured @ 90 PSI (620 kPa) compressed air pressure.
 ★ Available on GSA Advantage website @ www.GSAadvantage.gov

AEROLITE

COMPOSITE HOUSING

Non Vac DA (Dual Action / Random Orbital)

- **Random Orbital (RO) or Dual Action (DA)** sanders simultaneously spin the sanding disk and move in an ellipse. This unique random sanding action eliminates swirl marks in your work. They are available in 3 sizes and 3 orbits.



Sander Features

- J-Hook backup pad for hook & loop abrasives
- Ergonomic Wrist support
- ¼" (6.4mm) Air inlet
- Consumes 17 cfm (481 lpm)
- Produces 12,000 rpm & .28 hp (209 w)

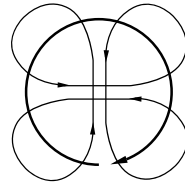

5/16 (8mm) Orbit
Aggressive Sanding

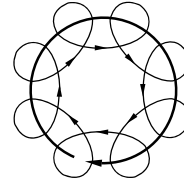

3/16 (5mm) Orbit
Normal Sanding



3/32 (2.5mm) Orbit
Finish Sanding

🔊 Don't forget our interface and protector pads to extend the life of your backup pad!

DA Sanders - Non Vac

Model	Pad Size	NSN	Orbit inch (mm)	Sound dBA	Weight lbs (kg)	Price
675-12310J	3" (75mm)		3/32 (2)	72	1.4 (0.65)	
675-12300J	3" (75mm)		3/16 (5)	72	1.5 (0.67)	
670-12510J	5" (125mm)		3/32 (2)	74	1.7 (0.77)	
670-12500J	5" (125mm)		3/16 (5)	74	1.8 (0.79)	
670-12520J	5" (125mm)		5/16 (8)	74	1.8 (0.82)	
670-12610J	6" (150mm)		3/32 (2)	74	1.8 (0.82)	
670-12600J	6" (150mm)		3/16 (5)	74	1.9 (0.85)	
670-12620J	6" (150mm)		5/16 (8)	74	1.9 (0.88)	



Air Tool Lubricant
00313
NSN: 4130-01-502-0850

* Replace J with S for Vinyl Pad on all models



① All tool performance ratings measured @ 90 PSI (620 kPa) compressed air pressure.
★ Available on GSA Advantage website @ www.GSAadvantage.gov

AEROLITE

COMPOSITE HOUSING

Non Vac Orbital



- **Central Vac** sanders require a portable or central vacuum for dust extraction. They come standard with a 1" threaded vacuum port for attachment to any Clayton vacuum system.
- **Orbital** or **Jitter** sanders move in an ellipse. They are typically used for fine finish sanding or getting into square corners. They are available in 3 sizes and 3 orbits.

Sander Features

- J-Hook backup pad for hook & loop abrasives
- Ergonomic Wrist support
- 1/4" (6.4mm) Air inlet
- Consumes 17 cfm (481 lpm)
- Produces 10,000 rpm & .28 hp (209 w)

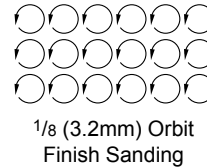

🔊 Don't forget our interface and protector pads to extend the life of your backup pad!

Orbital Sanders - Non Vac

Model	Pad Size	NSN	Sound dBA	Weight lbs (kg)	Price
675-10340J*	3 x 4" (75 x 100mm)		71	1.6 (0.71)	
675-10340J-80D	Corner 3 x 4" (75 x 100mm)		83	1.6 (0.73)	
675-10350J*	3 x 5" (75 x 125mm)		77	2.3 (1.05)	
675-10280J*	2-3/4 x 8" (70 x 200mm)		77	2.4 (1.07)	
670-10370J*	3-2/3 x 7" (90 x 175mm)		77	2.3 (1.05)	
675-10340J-56R	Radius 3 x 5" (75 x 100mm)		83	1.6 (0.73)	
675-10340J-66R	Radius 3 x 5" (75 x 100mm)		83	1.6 (0.73)	

* Replace J with S for Vinyl Pad on select models



Air Tool Lubricant
00313
NSN: 4130-01-502-0850



① All tool performance ratings measured @ 90 PSI (620 kPa) compressed air pressure.
★ Available on GSA Advantage website @ www.GSAadvantage.gov

AEROLITE



Composite Housing Two-Hand Sanders

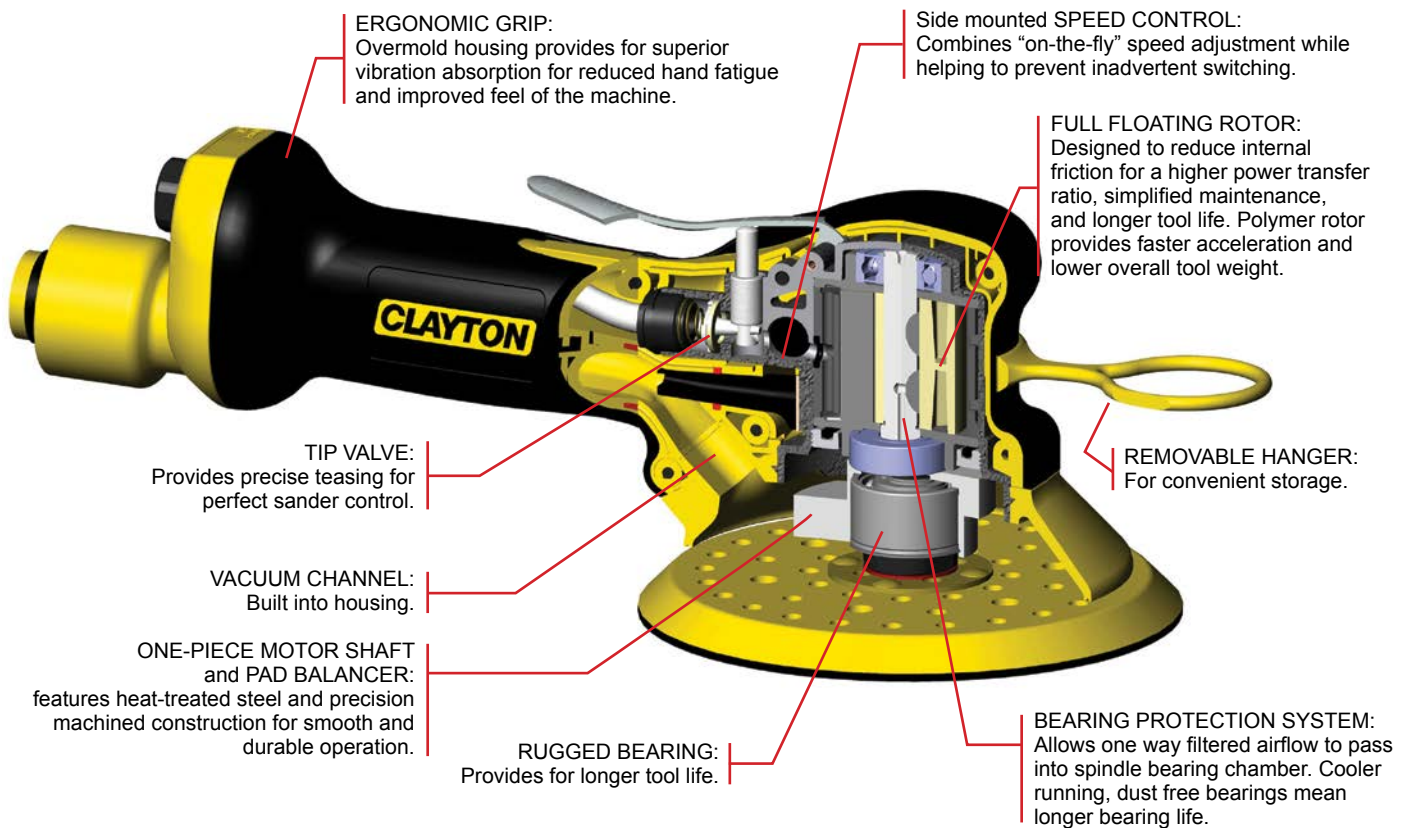

AEROLITE

COMPOSITE HOUSING

Central Vac Two-Hand DA (Dual Action / Random Orbital)

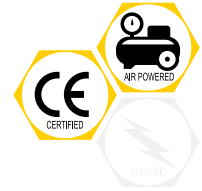

- **Central Vac** sanders require a portable or central vacuum for dust extraction. They come standard with a 1in threaded vacuum port for attachment to any Clayton vacuum system.
- **Random Orbital (RO)** or **Dual Action (DA)** sanders simultaneously spin the sanding disk and move in an ellipse. This unique random sanding action eliminates swirl marks in your work. They are available in 3 sizes and 3 orbits.

Sander Features

- J-Hook backup pad for hook & loop abrasives
- Vacuum hose swivel adapter 1in
- Built in Throttle Safety Lock
- ¼" (6.4mm) Air inlet
- Consumes 22 cfm (623 lpm)
- Produces 12,000 rpm & .45 hp (336 w)

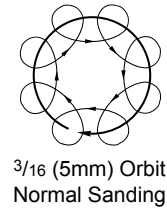
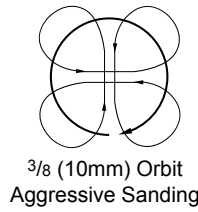

Two Hand DA Sanders - CV

Model	Pad Size	NSN	Orbit inch (mm)	Sound dBA	Weight lbs (kg)	Price
676-12501J	5" (125mm)		3/16 (5)	79	2.7 (1.22)	
676-12521J	5" (125mm)		3/8 (10)	79	2.7 (1.22)	
676-12601J	6" (150mm)		3/16 (5)	79	2.9 (1.29)	
676-12621J	6" (150mm)		3/8 (10)	79	2.9 (1.29)	
676-12801J	8" (203mm)		3/16 (5)	79	3.6 (1.61)	

* Replace J with S for Vinyl Pad on all models



① All tool performance ratings measured @ 90 PSI (620 kPa) compressed air pressure.
 ★ Available on GSA Advantage website @ www.GSAadvantage.gov

AEROLITE

COMPOSITE HOUSING

Self Generated Vac Two-Hand DA (Dual Action / Random Orbital)



- **Self Generated Vac** sanders use the sanders compressed air exhaust to generate their own vacuum for dust extraction. They come standard with a 1in threaded vacuum port. Bag & 1in Adapter Sold Separately.
- **Random Orbital (RO) or Dual Action (DA)** sanders simultaneously spin the sanding disk and move in an ellipse. This unique random sanding action eliminates swirl marks in your work. They are available in 3 sizes and 3 orbits.
- **Lubricant Contamination** on sensitive parts can be eliminated by using a Central Vac with any SGV Sander instead of a Bag, since all compressed air is diverted into the Vac Hose.

Sander Features

- J-Hook backup pad for hook & loop abrasives
- Vacuum hose swivel adapter 1in
- Built in Throttle Safety Lock
- 1/4" (6.4mm) Air inlet
- Bag swivel adapter 1in
- Consumes 22 cfm (623 lpm)
- Produces 12,000 rpm & .45 hp (336 w)

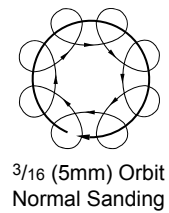
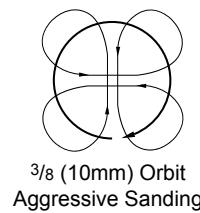

Two Hand DA Sanders - SGV

Model	Pad Size	NSN	Orbit inch (mm)	Sound dBA	Weight lbs (kg)	Price
676-12503J	5" (125mm)		3/16 (5)	79	2.7 (1.22)	
676-12523J	5" (125mm)		3/8 (10)	79	2.7 (1.22)	
676-12603J	6" (150mm)		3/16 (5)	79	2.9 (1.29)	
676-12623J	6" (150mm)		3/8 (10)	79	2.9 (1.29)	
676-12803J	8" (203mm)		3/16 (5)	79	3.6 (1.61)	

* Replace J with S for Vinyl Pad on all models

Self Gen Sander Bags

Model	NSN	Description	Price
678-20453		3M Filter Bag Adapter	
678-20452		3M Clean Sanding Filter Bag 10 pk	
130123	4130-01-460-8514	3M Clean Sanding Filter Bag 100 pk	



① All tool performance ratings measured @ 90 PSI (620 kPa) compressed air pressure.
 ★ Available on GSA Advantage website @ www.GSAadvantage.gov

AEROLITE

COMPOSITE HOUSING

Non Vac Two-Hand DA (Dual Action / Random Orbital)

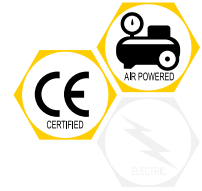

- **Central Vac** sanders require a portable or central vacuum for dust extraction. They come standard with a 1in threaded vacuum port for attachment to any Clayton vacuum system.
- **Random Orbital (RO) or Dual Action (DA)** sanders simultaneously spin the sanding disk and move in an ellipse. This unique random sanding action eliminates swirl marks in your work. They are available in 3 sizes and 3 orbits.

Sander Features

- J-Hook backup pad for hook & loop abrasives
- Vacuum hose swivel adapter 1in
- Built in Throttle Safety Lock
- ¼" (6.4mm) Air inlet
- Consumes 22 cfm (623 lpm)
- Produces 12,000 rpm & .45 hp (336 w)

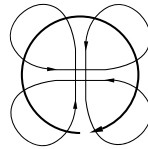

3/8 (10mm) Orbit
Aggressive Sanding

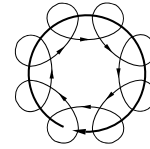

3/16 (5mm) Orbit
Normal Sanding

Two Hand DA Sanders - Non Vac

Model	Pad Size	NSN	Orbit inch (mm)	Sound dBA	Weight lbs (kg)	Price
676-12500J	5" (75mm)		3/16 (5)	79	2.7 (1.22)	
676-12520J	5" (75mm)		3/8 (10)	79	2.7 (1.22)	
676-12600J	6" (125mm)		3/16 (5)	79	2.9 (1.29)	
676-12620J	6" (125mm)		3/8 (10)	79	2.9 (1.29)	
676-12800J	8" (125mm)		3/16 (5)	79	3.6 (1.61)	

* Replace J with S for Vinyl Pad on all models

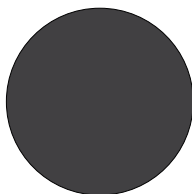

5in

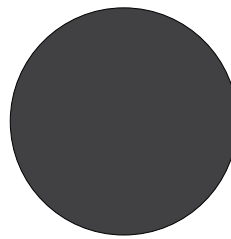

6in

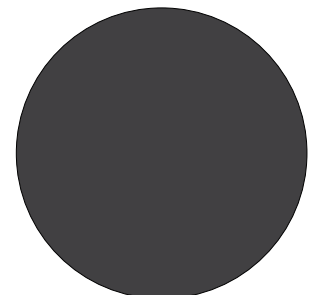

8in

① All tool performance ratings measured @ 90 PSI (620 kPa) compressed air pressure.
 ★ Available on GSA Advantage website @ www.GSAadvantage.gov

DURALITE



Aluminum Housing Palm Sanders

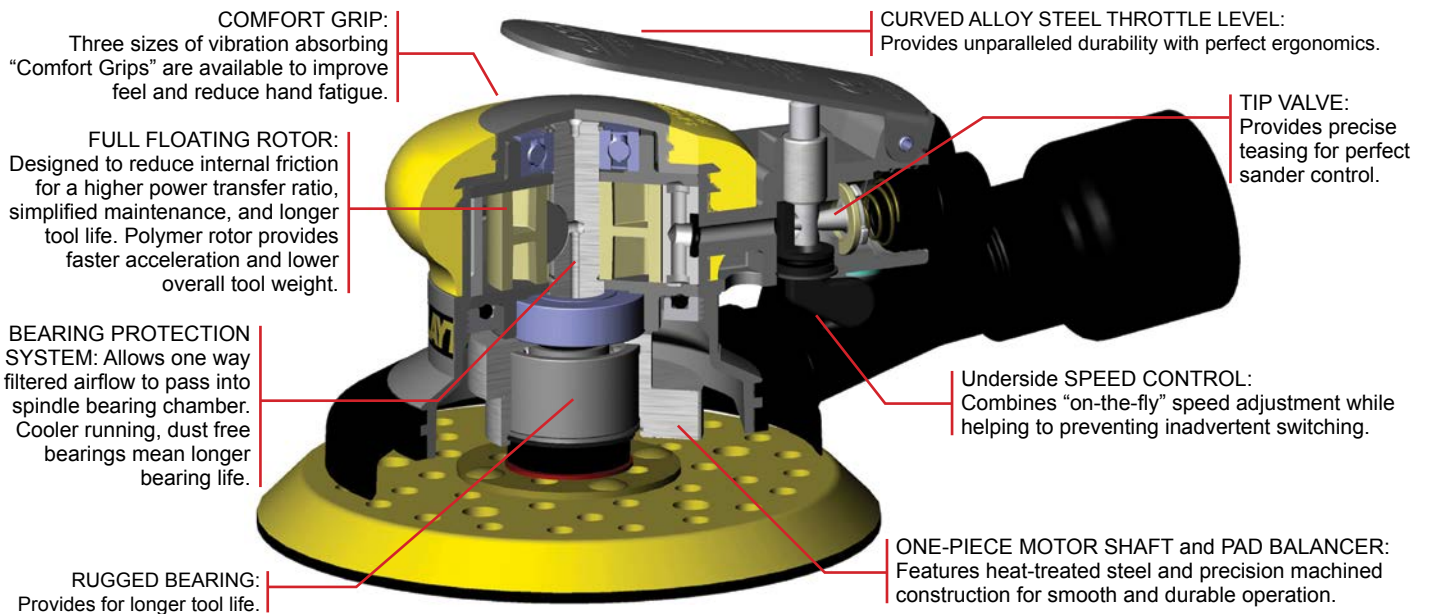

DURALITE

ALUMINUM HOUSING

Central Vac DA (Dual Action / Random Orbital)



- **Central Vac** sanders require a portable or central vacuum for dust extraction. They come standard with a 1in threaded vacuum port for attachment to any Clayton vacuum system.
- **Random Orbital (RO) or Dual Action (DA)** sanders simultaneously spin the sanding disk and move in an ellipse. This unique random sanding action eliminates swirl marks in your work. They are available in 3 sizes and 3 orbits.

Sander Features

- J-Hook backup pad for hook & loop abrasives
- Vacuum hose swivel adapter 1in
- Ergonomic Wrist support
- 1/4" (6.4mm) Air inlet
- Consumes 17 cfm (481 lpm)
- Produces 12,000 rpm & .28 hp (209 w)

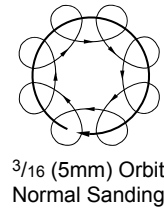
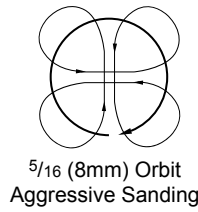

🔊 Don't forget our interface and protector pads to extend the life of your backup pad!

DA Sanders - CV

Model	Pad Size	NSN	Orbit inch (mm)	Sound dBA	Weight lbs (kg)	Price
775-12311J	3" (75mm)		3/32 (2)	72	1.6 (0.71)	
775-12301J	3" (75mm)		3/16 (5)	72	1.6 (0.73)	
775-12511J	5" (125mm)		3/32 (2)	74	1.8 (0.79)	
775-12501J	5" (125mm)		3/16 (5)	74	1.8 (0.82)	
775-12521J	5" (125mm)		5/16 (8)	74	1.9 (0.85)	
775-12611J	6" (150mm)		3/32 (2)	74	1.9 (0.85)	
775-12601J	6" (150mm)		3/16 (5)	74	1.9 (0.88)	
775-12621J	6" (150mm)		5/16 (8)	74	2 (0.93)	



Large 1in Central Vac Port

* Replace J with S for Vinyl Pad on all models

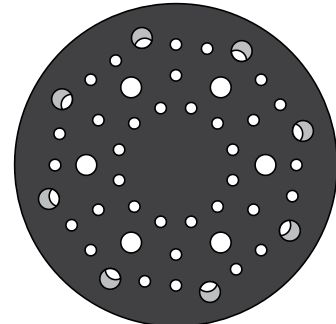
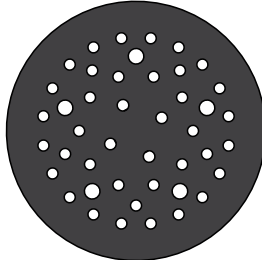
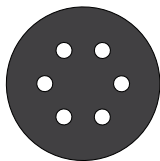

① All tool performance ratings measured @ 90 PSI (620 kPa) compressed air pressure.
 ★ Available on GSA Advantage website @ www.GSAadvantage.gov

DURALITE

ALUMINUM HOUSING

Central Vac Orbital

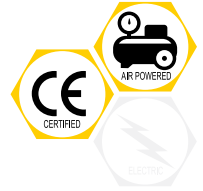

- **Central Vac** sanders require a portable or central vacuum for dust extraction. They come standard with a 1in threaded vacuum port for attachment to any Clayton vacuum system.
- **Orbital** or **Jitter** sanders move front to back and side to side simultaneously. They are typically used for fine finish sanding or getting into square corners. They are available in 7 sizes, all 1/8in orbit.

Sander Features

- J-Hook backup pad for hook & loop abrasives
- Vacuum hose swivel adapter 1in
- Ergonomic Wrist support
- 1/4" (6.4mm) Air inlet
- Consumes 17 cfm (481 lpm)
- Produces 12,000 rpm & .28 hp (209 w)

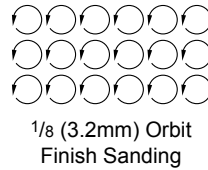

Orbital Sanders - CV

Model	Pad Size	NSN	Sound dBA	Weight lbs (kg)	Price
775-10341J*	3 x 4" (75 x 100mm)	5130-01-520-5670	71	1.6 (0.73)	
775-10341J-80D	Corner 3 x 4" (75 x 100mm)		71	1.6 (0.73)	
775-10351J*	3 x 5" (75 x 125mm)		77	2.4 (1.07)	
775-10281J*	2-3/4 x 8" (70 x 200mm)		77	2.4 (1.07)	
775-10371J*	3-2/3 x 7" (90 x 175mm)	5130-01-520-5672	77	2.4 (1.07)	
775-10341J-56R	Radius 3 x 5" (75 x 100mm)		77	1.6 (0.73)	
775-10341J-66R	Radius 3 x 5" (75 x 100mm)		77	1.6 (0.73)	



Large 1in Central Vac Port

* Replace J with S for Vinyl Pad on select models



DURALITE

ALUMINUM HOUSING

Self Generated Vac DA (Dual Action / Random Orbital)

• **Self Generated Vac** sanders use the sanders compressed air exhaust to generate their own vacuum for dust extraction. They come standard with a 1in threaded vacuum port. Bag & 1in Bag Adapter Sold Separately.

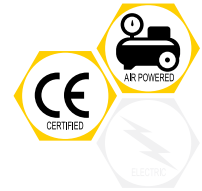

• **Random Orbital (RO)** or **Dual Action (DA)** sanders simultaneously spin the sanding disk and move in an ellipse. This unique random sanding action eliminates swirl marks in your work. They are available in 3 sizes and 3 orbits.

• **Lubricant Contamination** on sensitive parts can be eliminated by using a Central Vac with any SGV Sander instead of a Bag, since all compressed air is diverted into the Vac Hose.

Sander Features

- J-Hook backup pad for hook & loop abrasives
- Bag swivel adapter 1in
- Ergonomic Wrist support
- ¼" (6.4mm) Air inlet
- Consumes 17 cfm (481 lpm)
- Produces 12,000 rpm & .28 hp (209 w)

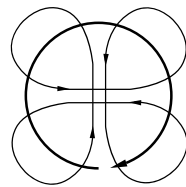

5/16 (8mm) Orbit
Aggressive Sanding

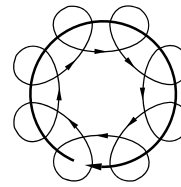

3/16 (5mm) Orbit
Normal Sanding

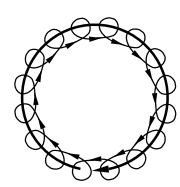

3/32 (2.5mm) Orbit
Finish Sanding

🔊 Don't forget our interface and protector pads to extend the life of your backup pad!

DA Sanders - Self Gen

Model	Pad Size	NSN	Orbit inch (mm)	Sound dBA	Weight lbs (kg)	Price
775-12313J	3" (75mm)		3/32 (2)	87	1.6 (0.71)	
775-12303J	3" (75mm)		3/16 (5)	87	1.6 (0.73)	
775-12513J	5" (125mm)		3/32 (2)	87	1.8 (0.79)	
775-12503J	5" (125mm)		3/16 (5)	87	1.8 (0.82)	
775-12523J	5" (125mm)		5/16 (8)	87	1.9 (0.85)	
775-12613J	6" (150mm)		3/32 (2)	87	1.9 (0.85)	
775-12603J	6" (150mm)		3/16 (5)	87	1.9 (0.88)	
775-12623J	6" (150mm)		5/16 (8)	87	2 (0.93)	

* Replace J with S for Vinyl Pad on all models

Self Gen Sander Bags

Model	NSN	Description	Price
678-20453		3M Filter Bag Adapter	
678-20452		3M Clean Sanding Filter Bag 10 pk	
130123	4130-01-460-8514	3M Clean Sanding Filter Bag 100 pk	



3in

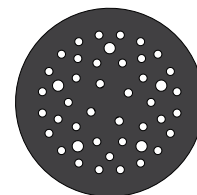

5in

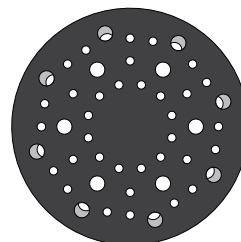

6in



① All tool performance ratings measured @ 90 PSI (620 kPa) compressed air pressure.

* Available on GSA Advantage website @ www.GSAadvantage.gov

DURALITE

ALUMINUM HOUSING

Self Generated Vac Orbital



- **Self Generated Vac** sanders use the sanders compressed air exhaust to generate their own vacuum for dust extraction. They come standard with a 1in threaded vacuum port. Bag & 1in Adapter Sold Separately.
- **Orbital** or **Jitter** sanders move front to back and side to side simultaneously. They are typically used for fine finish sanding or getting into square corners. They are available in 7 sizes, all 1/8in orbit.
- **Lubricant Contamination** on sensitive parts can be eliminated by using a Central Vac with any SGV Sander instead of a Bag, since all compressed air is diverted into the Vac Hose.

Sander Features

- J-Hook backup pad for hook & loop abrasives
- Bag swivel adapter 1in
- Ergonomic Wrist support
- 1/4" (6.4mm) Air inlet
- Consumes 17 cfm (481 lpm)
- Produces 10,000 rpm & .28 hp (209 w)



1/8 (3.2mm) Orbit
Finish Sanding



Large 1in SGV Bag Port

Orbital Sanders - Self Gen

Model	Pad Size	NSN	Sound dBA	Weight lbs (kg)	Price
775-10343J*	3 x 4" (75 x 100mm)		83	1.6 (0.73)	
775-10343J-80D	Corner 3 x 4" (75 x 100mm)		83	1.6 (0.73)	
775-10353J*	3 x 5" (75 x 125mm)		91	2.4 (1.07)	
775-10283J*	2-3/4 x 8" (70 x 200mm)		91	2.4 (1.07)	
775-10373J*	3-2/3 x 7" (90 x 175mm)		91	2.4 (1.07)	
775-10343J-56R	Radius 3 x 5" (75 x 100mm)		83	1.6 (0.73)	
775-10343J-66R	Radius 3 x 5" (75 x 100mm)		83	1.6 (0.73)	

* Replace J with S for Vinyl Pad on select models



① All tool performance ratings measured @ 90 PSI (620 kPa) compressed air pressure.
 * Available on GSA Advantage website @ www.GSAadvantage.gov

DURALITE

ALUMINUM HOUSING

Non Vac DA (Dual Action / Random Orbital)

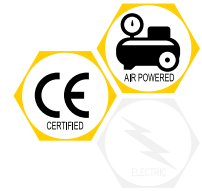

• **Random Orbital (RO) or Dual Action (DA)** sanders simultaneously spin the sanding disk and move in an ellipse. This unique random sanding action eliminates swirl marks in your work. They are available in 3 sizes and 3 orbits.

Sander Features

- J-Hook backup pad for hook & loop abrasives
- Ergonomic Wrist support
- 1/4" (6.4mm) Air inlet
- Consumes 17 cfm (481 lpm)
- Produces 12,000 rpm & .28 hp (209 w)

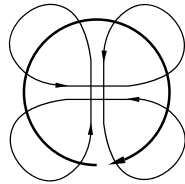

5/16 (8mm) Orbit
Aggressive Sanding

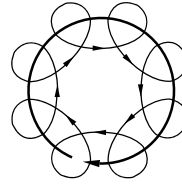

3/16 (5mm) Orbit
Normal Sanding



3/32 (2.5mm) Orbit
Finish Sanding

🔊 Don't forget our interface and protector pads to extend the life of your backup pad!

DA Sanders - Non Vac

Model	Pad Size	NSN	Orbit inch (mm)	Sound dBA	Weight lbs (kg)	Price
775-12310J	3" (75mm)		3/32 (2)	72	1.6 (0.71)	
775-12300J	3" (75mm)		3/16 (5)	72	1.6 (0.73)	
775-12510J	5" (125mm)		3/32 (2)	74	1.8 (0.79)	
775-12500J	5" (125mm)		3/16 (5)	74	1.8 (0.82)	
775-12520J	5" (125mm)		5/16 (8)	74	1.9 (0.85)	
775-12610J	6" (150mm)		3/32 (2)	74	1.9 (0.85)	
775-12600J	6" (150mm)		3/16 (5)	74	1.9 (0.88)	
775-12620J	6" (150mm)		5/16 (8)	74	2 (0.93)	



Air Tool Lubricant
00313
NSN: 4130-01-502-0850

* Replace J with S for Vinyl Pad on all models

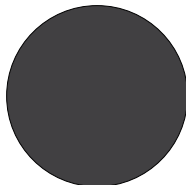

3in

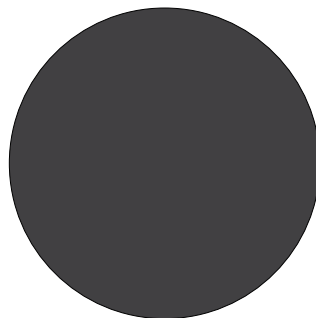

5in

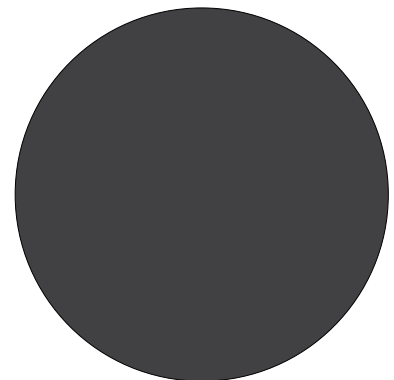

6in

DURALITE

ALUMINUM HOUSING

Non Vac Orbital



- **Central Vac** sanders require a portable or central vacuum for dust extraction. They come standard with a 1" threaded vacuum port for attachment to any Clayton vacuum system.
- **Orbital** or **Jitter** sanders move in an ellipse. They are typically used for fine finish sanding or getting into square corners. They are available in 3 sizes and 3 orbits.

Sander Features

- J-Hook backup pad for hook & loop abrasives
- Ergonomic Wrist support
- 1/4" (6.4mm) Air inlet
- Consumes 17 cfm (481 lpm)
- Produces 10,000 rpm & .28 hp (209 w)

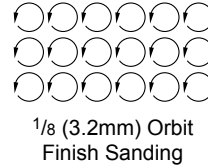

🔊 Don't forget our interface and protector pads to extend the life of your backup pad!

Orbital Sanders - Non Vac

Model	Pad Size	NSN	Sound dBA	Weight lbs (kg)	Price
775-10340J*	3 x 4" (75 x 100mm)		71	1.6 (0.71)	
775-10340J-80D	Corner 3 x 4" (75 x 100mm)		83	1.6 (0.73)	
775-10350J*	3 x 5" (75 x 125mm)		77	2.3 (1.05)	
775-10280J*	2-3/4 x 8" (70 x 200mm)		77	2.4 (1.07)	
775-10370J*	3-2/3 x 7" (90 x 175mm)		77	2.3 (1.05)	
775-10340J-56R	Radius 3 x 5" (75 x 100mm)		83	1.6 (0.73)	
775-10340J-66R	Radius 3 x 5" (75 x 100mm)		83	1.6 (0.73)	

* Replace J with S for Vinyl Pad on select models



Air Tool Lubricant
00313
NSN: 4130-01-502-0850

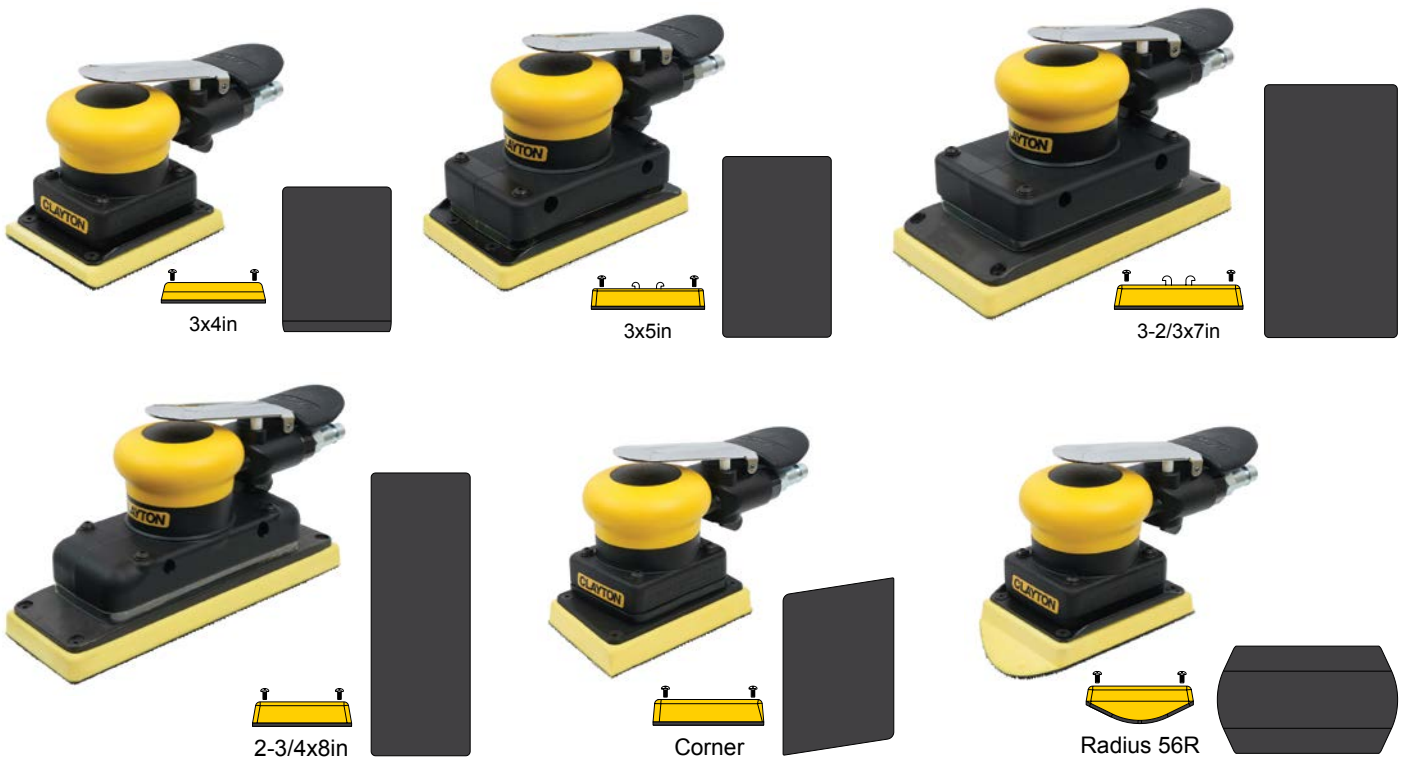

ELECTROLITE



Electric Palm Sanders

ELECTROLITE

COMPOSITE HOUSING

Central Vac DA (Dual Action / Random Orbital)

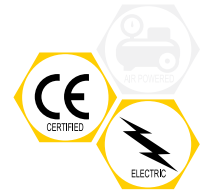

- **Central Vac** sanders require a portable or central vacuum for dust extraction. They come standard with a 1in threaded vacuum port for attachment to any Clayton vacuum system.
- **Random Orbital (RO) or Dual Action (DA)** sanders simultaneously spin the sanding disk and move in an ellipse. This unique random sanding action eliminates swirl marks in your work. They are available in 3 sizes and 3 orbits.

Sander Features

- J-Hook backup pad for hook & loop abrasives
- Vacuum hose swivel adapter 1in
- Ergonomic Wrist support
- 120VAC 150W
- Produces 10,000 rpm

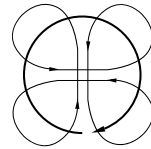

5/16 (8mm) Orbit
Aggressive Sanding

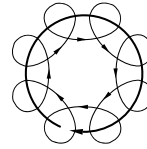

3/16 (5mm) Orbit
Normal Sanding



3/32 (2.5mm) Orbit
Finish Sanding

🔊 Don't forget our interface and protector pads to extend the life of your backup pad!

DA Sanders - CV

Model	Pad Size	Orbit inch (mm)	Sound dBA	Weight lbs (kg)	Price
870-10311J	3" (150mm)	3/32 (2)		0 (0)	
870-10301J	3" (150mm)	3/16 (5)		0 (0)	
870-10511J	5" (125mm)	3/32 (2)		0 (0)	
870-10501J	5" (125mm)	3/16 (5)		0 (0)	
870-10611J	6" (150mm)	3/32 (2)		0 (0)	
870-10601J	6" (150mm)	3/16 (5)		0 (0)	

* Replace J with S for Vinyl Pad on all models



Large 1in
Central Vac Port



3in

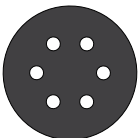

5in

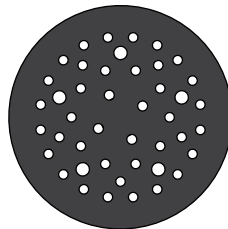

6in

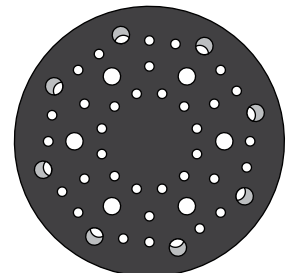

① All tool performance ratings measured @ 90 PSI (620 kPa) compressed air pressure.
 ★ Available on GSA Advantage website @ www.GSAadvantage.gov

ELECTROLITE

COMPOSITE HOUSING

Central Vac Orbital

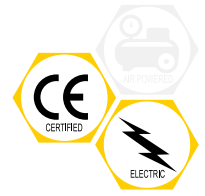

- **Central Vac** sanders require a portable or central vacuum for dust extraction. They come standard with a 1in threaded vacuum port for attachment to any Clayton vacuum system.
- **Orbital** or **Jitter** sanders move front to back and side to side simultaneously. They are typically used for fine finish sanding or getting into square corners. They are available in 2 sizes, all 1/8in orbit.

Sander Features

- J-Hook backup pad for hook & loop abrasives
- Vacuum hose swivel adapter 1in
- Ergonomic Wrist support
- 120VAC 150W
- Produces 10,000 rpm



1/8 (3.2mm) Orbit
Finish Sanding

🔊 Don't forget our interface and protector pads to extend the life of your backup pad!

DA Sanders - CV

Model	Pad Size	NSN	Orbit inch (mm)	Sound dBA	Weight lbs (kg)	Price
870-10341J*	3 x 4" (75 x 100mm)		1/8 (3)		0 (0)	
870-10281J*	2-3/4 x 8" (75 x 100mm)		1/8 (3)		0 (0)	

* Replace J with S for Vinyl Pad on all models



Large 1in Central Vac Port



2-3/4x8in

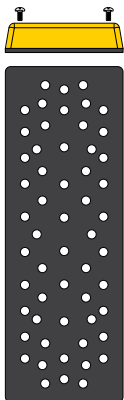

3x4in

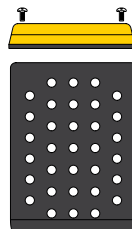

① All tool performance ratings measured @ 90 PSI (620 kPa) compressed air pressure.
 ★ Available on GSA Advantage website @ www.GSAadvantage.gov

Radius 3" x 5" Orbital Sanders

This innovative sander was designed to help OEMs and maintainers deal with the concave surfaces of certain aircraft jet intakes. In the past, sanders would only make contact with the outer edges of the abrasive on concave surfaces. These tools follow the contour of the aircraft skin providing even contact over the entire abrasive surface. Lightweight and rugged composite housing with patented bearing design for extended motor life.



- Designed in cooperation with Lockheed Martin for F-22 intakes
- Designed in cooperation with Northrop Grumman for F-35 intakes
- Available in two sizes for narrow and wide concave areas
- Backup pad extended nose and tail allows sander to accept 5" disc abrasives

Sanders include:

- Curved J-Hook backup pad for hook & loop abrasives
- Swivel adapter for 1" vacuum hose
- Wrist support
- Standard 3/16" orbit and 10,000 RPM
- 1/4" Air Inlet

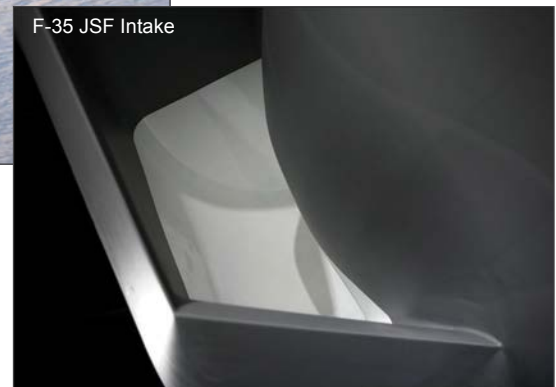

Radius 3" x 5" Orbital Sander (75 x 100 mm)

Model	NSN	Radius	Motor HP (W)	Sound dBA	Air Consumption CFM (LPM)	Weight lbs (kg)	Price
675-10341J-56R		Short	0.28 (209)	72	17 (481)	25.8 (0.73)	
675-10341J-66R		Long	0.28 (209)	72	17 (481)	25.8 (0.73)	

Radius Pads

Model	NSN	Size	Holes	Radius	Abrasive Attachment	Price
672-401J-56R		3 x 5	33	Short	J-Hook	
672-401J-66R		3 x 5	33	Long	J-Hook	

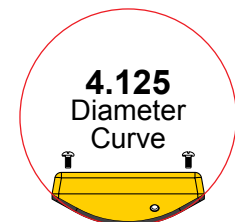
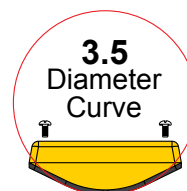

① All tool performance ratings measured @ 90 PSI (620 kPa) compressed air pressure.
 ★ Available on GSA Advantage website @ www.GSAadvantage.gov

Extended Reach Low Profile Sander Option

This was designed to help maintainers deal with small spaces like ECS ducts or between jet intakes and the aircraft fuselage. At only 3" tall, the Extended Reach Low Profile Sander option fits deep into tight spaces. The actuator has been relocated from the top of sander to the airline and the sander can be held by the extended rigid air line connection.



- Designed by Clayton and tested by engineers at Lockheed Martin on the F-22
- Sander not included.
- This is a factory installed option.
- Simultaneous sander purchase required.

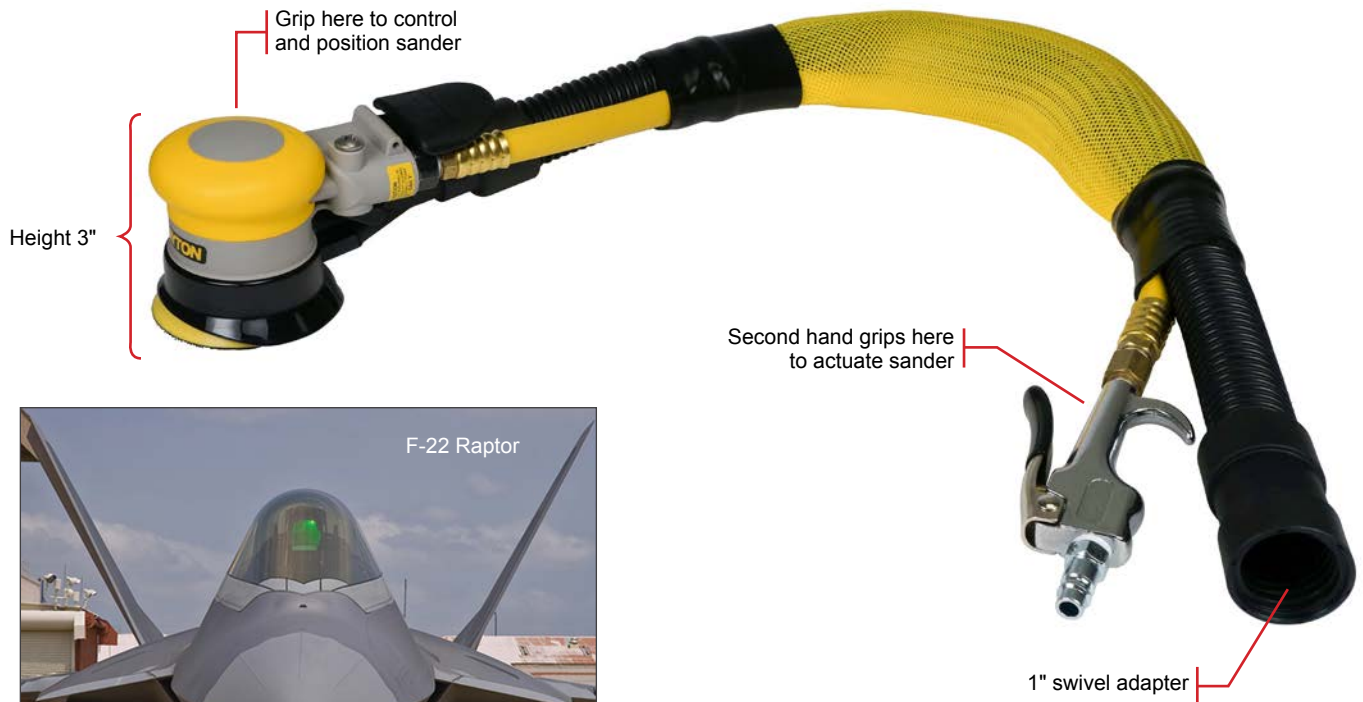

Extended Reach Low Profile Sander Option

Model	NSN	Description
690-026		Extended Reach Low Profile Sander Option

**Factory installed option only.
Simultaneous sander purchase required.**

① All tool performance ratings measured @ 90 PSI (620 kPa) compressed air pressure.
 ★ Available on GSA Advantage website @ www.GSAadvantage.gov

HAND SANDING BLOCKS

Vacuum Hand Sanding Blocks

Clayton hand sanding blocks provide dust free sanding without a compressed air supply. They're ideal for quick spot repairs or areas where finesse is required. The hand sanding blocks can be easily connected to either a Clayton vacuum system or a central vacuum. The ergonomic design fits comfortably in the palm and ensures fatigue-free sanding. For best results, use these sanders with DustMaster Supreme Screen Abrasives.

Features

- Hook & Loop attachment for abrasives
- Vacuum Relief Valve
- 1in Swivel Connection
- 2ft x 1in Vacuum Hose and Cuff

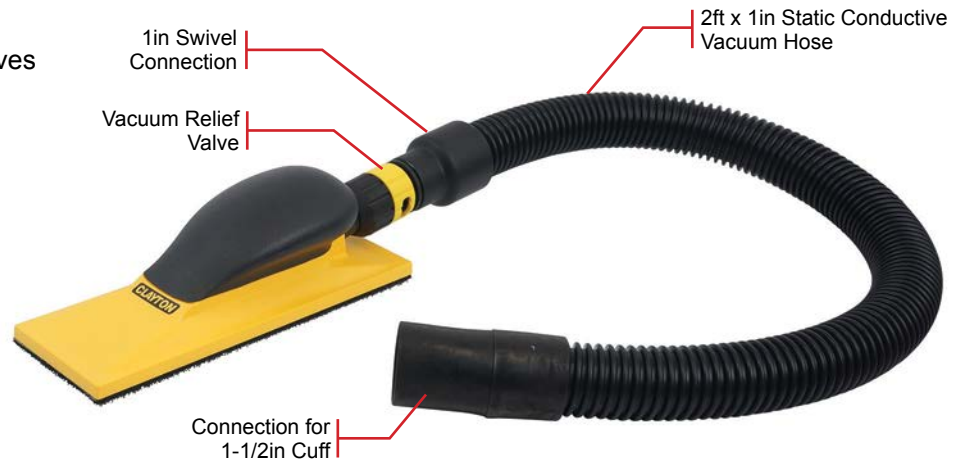

Hand Sanding Blocks

Model	NSN	Description	Price
680-A27505J	4130-01-509-0261	Hand Sander 2.75in x 5in	
680-A27508J		Hand Sander 2.75in x 8in	
680-A27516J		Hand Sander 2.75in x 16in	
680-A275R16J		Hand Sander 2.75in x 16in Symmetric Rigid	
680-A275F16J		Hand Sander 2.75in x 16in Symmetric Flex	
680-A275XXJ	4130-01-509-0276	Hand Sander Kit 5in, 8in, 16in	



2-3/4 x 5



2-3/4 x 8



2-3/4 x 16



2-3/4 x 16 Symmetric

The **Symmetric Flex** Hand Sanding Block can be adjusted to Concave, Flat, or Convex surfaces.

Features

- Hook & Loop attachment for abrasives
- Vacuum Relief Valve
- 1in Swivel Connection
- 2ft x 1in Vacuum Hose and Cuff



2-3/4 x 16 Symmetric Flex

HAND SANDING BLOCKS

Vacuum Hand Sanding Blocks

The **Curved Shape Kits** provide interchangeable concave and convex backup pads that snap on and off the hand sander bodies.

Features

- Hook & Loop attachment for abrasives
- Vacuum Relief Valve
- 1in Swivel Connection
- 2ft x 1in Vacuum Hose and Cuff
- Available in 3 Sizes

Hand Sanding Blocks Curved Shapes

Model	NSN	Description	Price
680-A27505CK		Hand Sander 2.75in x 5in Curved Shapes Kit	
680-A27508CK		Hand Sander 2.75in x 8in Curved Shapes Kit	
680-A27505DK		Hand Sander 2.75in x 5in Disc Curved Shapes Kit	
680-A275F16J		Hand Sander 2.75in x 16in Symmetric Flex	



2-3/4 x 5 Curved Shapes Kit

Accepts 2-3/4 x 5in Abrasive

Features

- 1 5in Sander Body
- 1 Flat Pad
- 1 Concave Pad
- 2 Different convex pads



2-3/4 x 8 Curved Shapes Kit

Accepts 2-3/4 x 8in Abrasive

Features

- 1 8in Sander Body
- 1 Flat Pad
- 1 Concave Pad
- 2 Different Convex Pads



5in Disc Curved Shapes Kit

Accepts 5in Disc Abrasive

Features

- 1 5in Sander Body
- 1 Flat Pad
- 1 Concave Pad
- 1 Convex Pad



SANDER PARTS & ACCESSORIES

Backup Pads • Pad Protectors • Interface Pads • Sander Parts • Drop In Motors



Circular Backup Pads

Clayton has a wide variety of backup pads for all your sanding needs.

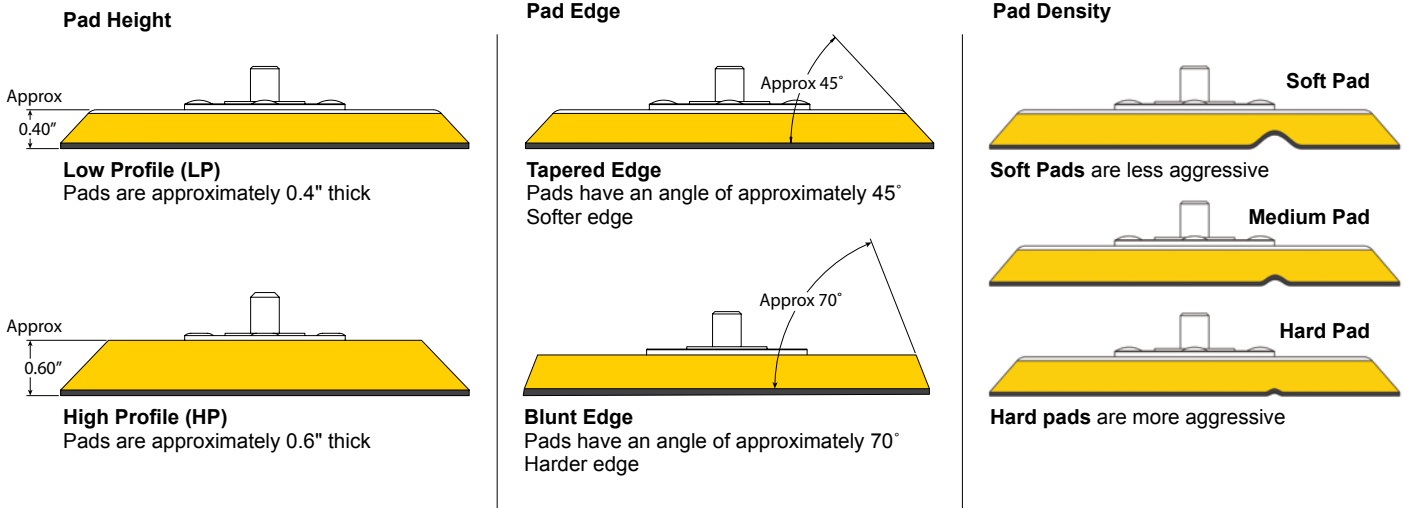

Hook Pads uses tiny hooks to hold the abrasive loops securely to the sander.

JHook Pads uses longer hooks hold the abrasive loops securely to the sander. The JHooks are longer than the hooks in the Hook attachment method and create a small space between the abrasive and foam pad. This channel provides more air flow and better transport for the dust across and thru the disc, and slightly more cushion for better performance on contours. JHook is preferred for screen abrasives.

Vinyl Pads have a smooth vinyl surface and a small number of large holes for dust collection.

Disc Pads Hook & Loop Multi-Hole

These low profile tapered edge backup pads are designed specifically for vacuum sanding. The large number of holes provides unmatched airflow and dust capture. They come standard on all Clayton sanders and feature J-Hook abrasive attachment and multi-hole pattern for maximum air flow.

Disc Pads Hook & Loop Multi-Hole

Model	NSN	Desc	Price
672-511H		Backup Pad 5in Multihole Hook LP	
672-511J	4130-01-531-6807	Backup Pad 5in MultiHole JHook LP	
672-511JH		Backup Pad 5in MultiHole JHook LP Hard	
672-511JS		Backup Pad 5in MultiHole JHook LP Soft	
672-611H		Backup Pad 6in Multihole Hook LP	
672-611J	4130-01-531-6803	Backup Pad 6in Multihole JHook LP	
672-611JH		Backup Pad 6in Multihole JHook LP Hard	
672-611JS		Backup Pad 6in Multihole JHook LP Soft	
672-811H		Backup Pad 8in Multihole Hook LP	



5in and 6in (5/16-18 Stud)



8in (8 x 1/4-20 Female)

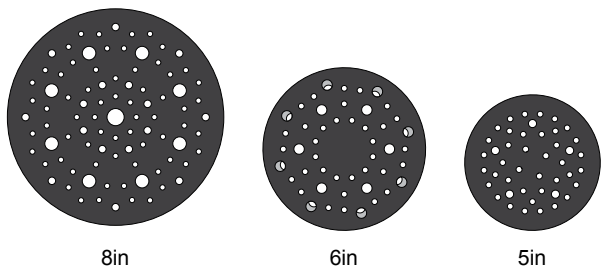

Disc Pads Hook & Loop Standard-Hole

These pads are available in Low Profile / High Profile, Tapered Edge / Blunt Edge, Hook / JHook.

Disc Pads Hook & Loop Standard-Hole

Model	NSN	Desc	Price
672-301H		Backup Pad 3in 6 Hole Hook LP	
672-301J	4130-01-459-5206	Backup Pad 3in 6 Hole JHook LP	
672-351J	4130-01-526-0051	Backup Pad 3-1/2in 6 Hole JHook LP	
672-501H		Backup Pad 5in 5 Hole Hook LP	
672-501J	4130-01-531-6799	Backup Pad 5in 5 Hole JHook LP	
672-601H		Backup Pad 6in 6 Hole Hook LP	
672-601J		Backup Pad 6in 6 Hole JHook LP	
675-511H		Backup Pad 5in 5-Hole Hook Tapered	
675-511J		Backup Pad 5in 5-Hole JHook Tapered	
675-611H		Backup Pad 6in 6-Hole Hook Tapered	
675-611J		Backup Pad 6in 6 Hole JHook Tapered	



5in and 6in



8in

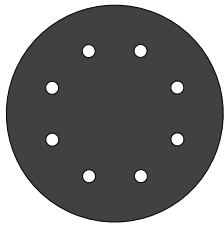

8in

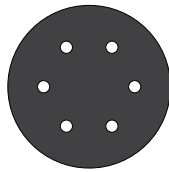

6in

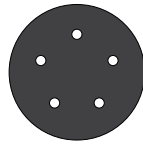

5in

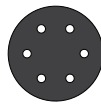

3.5in



3in

Disc Pads Hook & Loop No-Hole

These pads are available in Low Profile / High Profile, Tapered Edge / Blunt Edge, Hook / JHook.

Disc Pads Hook & Loop No-Hole

Model	NSN	Desc	Price
672-300H		Backup Pad 3in NV Hook LP	
672-300J		Backup Pad 3in NV JHook LP	
672-352H		Backup Pad 3-1/2in NV Hook LP	
672-500H		Backup Pad 5in NV Hook LP	
672-500J		Backup Pad 5in NV JHook LP	
672-510H		Backup Pad 5in NV Hook Tapered	
672-600H		Backup Pad 6in NV Hook LP	
672-600J		Backup Pad 6in NV JHook LP	
672-610H		Backup Pad 6in NV Hook Tapered	
672-610J		Backup Pad 6in NV JHook Tapered	



5in and 6in



8in

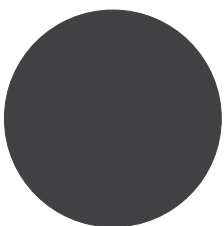

8in

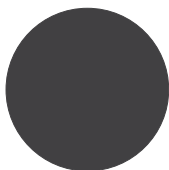

6in

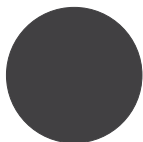

5in



3.5in



3in

Disc Pads Vinyl Standard-Hole

These pads are available in Low Profile / High Profile, Tapered Edge / Blunt Edge.

Disc Pads Vinyl Standard-Hole

Model	NSN	Desc	Price
672-301S		Backup Pad 3in 6 Hole Vinyl LP	
672-351S	4130-01-460-3205	Backup Pad 3-1/2in 6 Hole Vinyl LP	
672-501S		Backup Pad 5in 5 Hole Vinyl LP	
672-511S	4130-01-501-7031	Backup Pad 5in 5 Hole Vinyl Tapered	
672-601SH		Backup Pad 6in 6 Hole Vinyl LP Hard	
672-611S		Backup Pad 6in 6 Hole Vinyl Tapered	
672-811S		Backup Pad 8in 8 Hole Vinyl LP	



5in and 6in

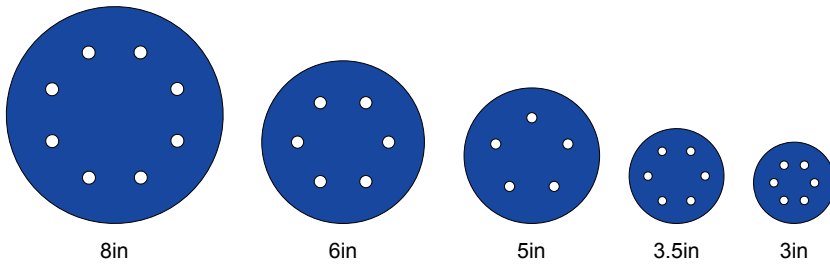

8in

Disc Pads Vinyl No-Hole

These pads are available in Low Profile / High Profile, Tapered Edge / Blunt Edge.

Disc Pads Vinyl No-Hole

Model	NSN	Desc	Price
672-300S		Backup Pad 3in NV Vinyl LP	
672-352S		Backup Pad 3-1/2in NV Vinyl LP	
672-500S		Backup Pad 5in NV Vinyl LP	
672-510S		Backup Pad 5in NV Vinyl Tapered	
672-600S		Backup Pad 6in NV Vinyl LP	
672-610S		Backup Pad 6in NV Vinyl Tapered	



5in and 6in

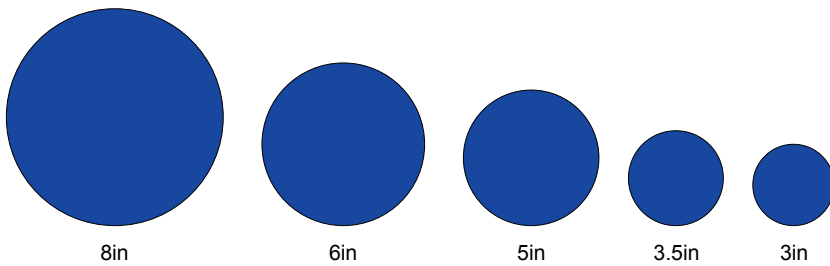

8in

Rectangular Backup Pads

Clayton has a wide variety of backup pads for all your sanding needs.

Sander Attachment



Screw-On Pads
Attach to the sander with 4 screws



Peel and Stick Pads
Attach to the sander with peel and stick adhesive



Hook Pads uses tiny hooks to hold the abrasive loops securely to the sander.



JHook Pads uses tiny hooks and loops to hold the abrasive securely to the sander. The JHooks are longer than the hooks in the Hook attachment method and create a small space between the abrasive and foam pad. This channel provides more air flow and better transport for the dust across and thru the disc and slightly more cushion for better contour following. JHook is preferred for screen abrasives.



Vinyl Pads typically have a smooth vinyl surface and a small number of large holes for dust collection.

Rectangular Pads Hook & Loop Multi-Hole Screw-On

These pads come standard on all Clayton sanders and feature 4 screw holes for attachment to your sander, J-Hook abrasive attachment, and multi-hole pattern for better air flow.

Rectangular Pads Hook & Loop Multi-Hole Screw-On

Model	NSN	Desc	Price
675-402J		Backup Pad 3x4 MultiHole JHook Screw On	
675-352J		Backup Pad 3x5 MultiHole JHook Screw On	
675-702J		Backup Pad 3-2/3 x 7 MultiHole JHook Screw On	
675-281J		Backup Pad 2-3/4 x 8 Multihole JHook Screw On	
675-353J		Backup Pad 3x4 Corner Multihole JHook Screw On	
672-401J-56R		Backup Pad Radius Short JHook	
672-401J-66R		Backup Pad Radius Long (Dot) JHook	

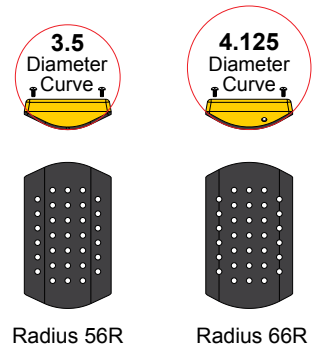
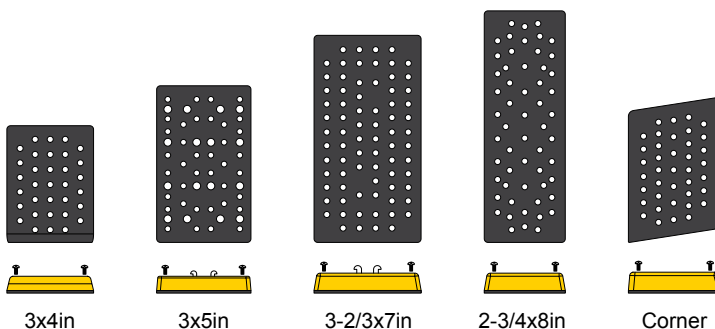

Rectangular Pads Hook & Loop Standard-Hole Screw-On

These pads are available in Hook / JHook and feature 4 screw holes for attachment to your sander.

Rectangular Pads Hook & Loop Standard-Hole Screw-On

Model	NSN	Desc	Price
675-401J		Backup Pad 3X4 Jhook 4 Hole	

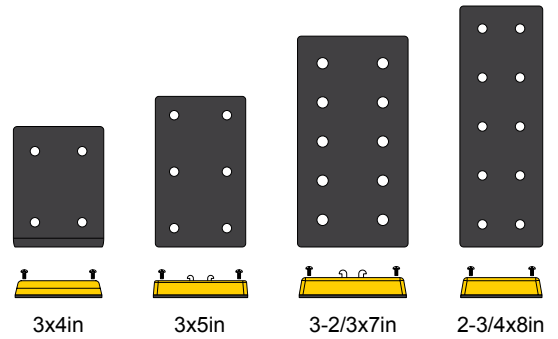

Rectangular Pads Hook & Loop No-Hole Screw-On

These pads are available in Hook / JHook and feature 4 screw holes for attachment to your sander.

Rectangular Pads Hook & Loop No-Hole Screw-On

Model	NSN	Desc	Price
675-700H		Backup Pad 3-2/3 x 7 NV Hook Screw On	
675-400H		Backup Pad 3x4 NV Hook Screw On	
675-280H		Backup Pad 2-3/4 x 8 NV Hook Screw On	

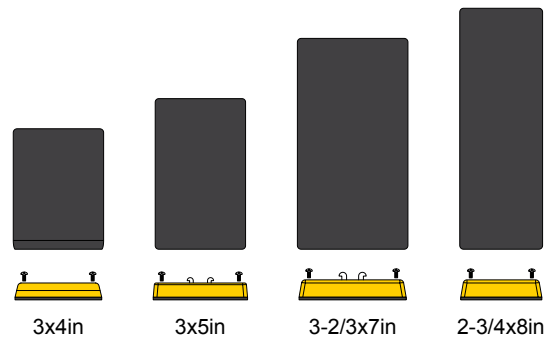

Rectangular Pads Hook & Loop Standard-Hole Stick-On

These pads are available in Hook / JHook and feature Peel & Stick adhesive for attachment to your sander.

Rectangular Pads Hook & Loop Standard-Hole Stick-On

Model	NSN	Desc	Price
672-701H		Backup Pad 3-2/3 x 7 10-Hole Hook Stick On	
672-701J		Backup Pad 3-2/3 x 7 10-Hole JHook Stick On	
672-402J		Backup Pad 3x4 Vac JHook Stick On 4 Hole	

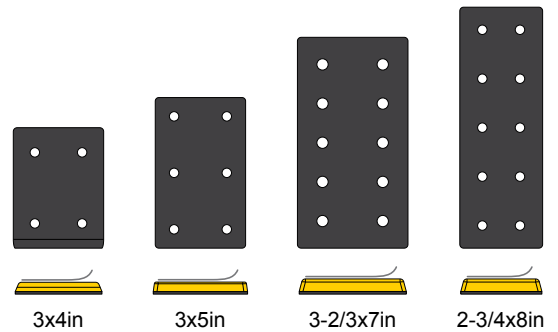

Rectangular Pads Hook & Loop No-Hole Stick-On

These pads are available in Hook / JHook and feature Peel & Stick adhesive for attachment to your sander.

Rectangular Pads Hook & Loop No-Hole Stick-On

Model	NSN	Desc	Price
672-700J		Backup Pad 3-2/3 x 7 NV JHook Stick On	
672-700H		Backup Pad 3-2/3 x 7 NV Hook Stick On	

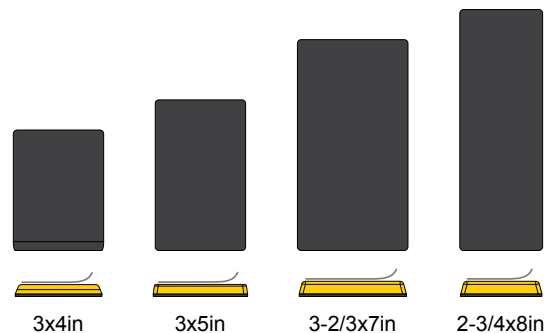

Rectangular Pads Vinyl Standard-Hole Screw-On

These pads feature 4 screw holes for attachment to your sander.

Rectangular Pads Vinyl Standard-Hole Screw-On

Model	NSN	Desc	Price
675-702S		Backup Pad 3-2/3 x 7 10-Hole Vinyl Screw On	
675-402S		Backup Pad 3x4 4-Hole Vinyl Screw On	

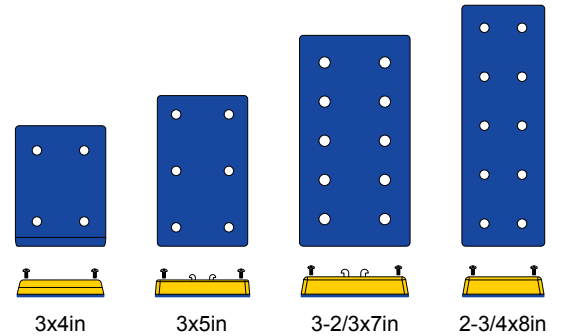

Rectangular Pads Vinyl No-Hole Screw-On

These pads feature 4 screw holes for attachment to your sander.

Rectangular Pads Vinyl No-Hole Screw-On

Model	NSN	Desc	Price
675-700S		Backup Pad 3-2/3 x 7 NV Vinyl Screw On	
675-400S		Backup Pad 3x4 NV Vinyl Screw On	
675-280S		Backup Pad 2-3/4 x 8 NV Vinyl Screw On	

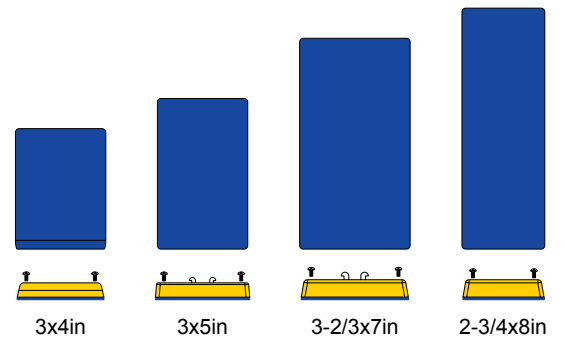

Rectangular Pads Vinyl Standard-Hole Stick-On

These pads feature Peel & Stick adhesive for attachment to your sander.

Rectangular Pads Vinyl Standard-Hole Stick-On

Model	NSN	Desc	Price
672-701S		Backup Pad 3-2/3 x 7 10-Hole Vinyl Stick On	

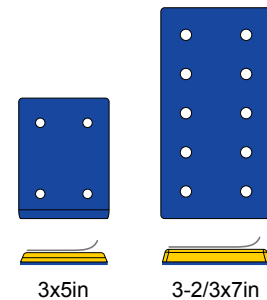

Rectangular Pads Vinyl No-Hole Stick-On

These pads feature Peel & Stick adhesive for attachment to your sander.

Rectangular Pads Vinyl No-Hole Stick-On

Model	NSN	Desc	Price
672-700S		Backup Pad 3-2/3 x 7 NV Vinyl Stick On	

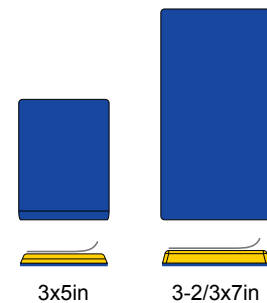

Disc Pads Vinyl Groove

If you need to use PSA abrasive but are looking for better air flow try our grooved PSA pads. The grooves provide airflow across and to the edge of the entire pad, eliminating the need to align the holes in the abrasive and the pad.

Disc Pads Vinyl Groove

Model	NSN	Size	Holes	Edge	Abrasive Attachment	Stud Size	Price
672-511SG	4130-01-458-8701	5"	5	Low Profile	PSA	5/16	
672-611SG	4130-01-458-8704	6"	8	Low Profile	PSA	5/16	



Grooved PSA



Low Profile Edge



* Available on GSA Advantage website @ www.GSAadvantage.gov

Pad Protectors

Extend the life of J-hook backup pads with pad protectors. Wear down these inexpensive disposable pads instead of valuable backup pads. Loop on one side, J-Hook on the other, these pads sit between your J-Hook backup pad and your abrasive.

Pad Protectors

Model	NSN	Size in (mm)	Thickness in (mm)	Pack Qty	Price
672-30JP		3 (76)	0.125 (3)	50	
672-34JP		3x4 (76x102)	0.125 (3)	50	
672-35JP	4130-01-459-5268	3.5 (89)	0.125 (3)	50	
672-37JP		3.66x7 (93x178)	0.125 (3)	50	
672-50JP	4130-01-482-1558	5 (127)	0.125 (3)	50	
672-60JP	4130-01-459-5701	6 (150)	0.125 (3)	50	



3in



3.5in



5in



6in



3 x 4 in



3-2/3 x 7 in

Interface Pads

Ideal for contour sanding, Interface Pads work just like Pad Protectors but are much thicker, allowing the abrasive to conform to uneven surfaces, like the leading edge of wings. Loop on one side, J-Hook on the other, these pads sit between your J-Hook backup pad and your abrasive.

Interface Pads

Model	NSN	Size in (mm)	Thickness in (mm)	Pack Qty	Price
672-31JP		3 (76)	0.25 (6)	25	
672-52JP		5 (127)	0.5 (13)	25	
672-62JP		6 (152)	0.5 (13)	25	
692-205JP		2.75x5 (70x127)	0.25 (6)	5	
692-208JP		2.75x8 (70x203)	0.25 (6)	5	



3in



5in



6in



2.75x5 in



2.75x8 in

* Available on GSA Advantage website @ www.GSAadvantage.gov



Repair Parts

Ergonomic Wrist Support

- Included on all Clayton palm sanders
- Provides additional wrist support
- Shields against cold exhaust
- Facilitates two-handed sanding
- Easily Removed
- Fits on all Clayton palm sanders



Sander Swivel Exhaust

- Use on Clayton ROS & OS palm sanders
- Available for 1" or 3/4" hose



Comfort Grips

Available in 3 sizes, reduce fatigue and increase user comfort. All Clayton sanders come standard with medium grip. Small and Large grips are optional.



Muffler

- Use on Clayton ROS & OS palm sanders
- One piece sintered bronze muffler
- Easy and quick to replace



Rotor, Vane, Key Set

- Use on Clayton ROS & OS palm sanders
- Supports both 10,000 & 12,000 RPM
- Five floating composite blades
- Produces .28hp @ 90 psi – 17 cfm



Sander Rebuild Kits

Available for all sanders, includes: rotors, vanes & key, valve, valve seat, valve spring, muffler, o-rings, retaining rings, valve stem, bearings, shims, pad support assemblies as required for each model sander.



Sander Rebuild Tools

Contains the tools needed to service all Clayton Orbital and Random Orbital sanders.

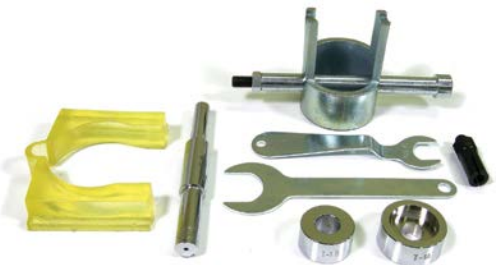

Air Tool Lubricant

Keep your pneumatic air tools running efficiently with air tool lubricant. Use 2-3 drops at the end of each day, or as needed, to maintain tool performance.



Palm Sander Accessories

Model	NSN	Description	"Weight lbs (kg)"	Price
673-M0201		Ergonomic Wrist Support		
673-A0288		Comfort Grip Small 2-1/2"		
673-A0289		Comfort Grip Medium 2-3/4"		
673-A0290		Comfort Grip Large 3"		
673-A0099		Swivel Exhaust 1" for ROS		
673-A0092		Swivel Exhaust 1" for OS		
673-A0205	4730-01-520-3909	Swivel Exhaust 3/4" for ROS		
673-A0298	5340-01-519-5882	Swivel Exhaust 3/4" for OS		
673-C0047		Shroud 3" 3/32 Orbit		
673-C0243		Shroud 3" 3/16 Orbit		
673-C0012		Shroud 5"		
673-C0073	4460-01-519-5859	Shroud 6"		
673-A0095		10,000 RPM Muffler for ROS		
673-A0096		12,000 RPM Muffler for ROS		
00313	4130-01-502-0850	Air Tool Lubricant		

Palm Sander Parts

Model	NSN	Description	Weight lbs (kg)	Price
673-A0612		ROS Spindle Bearing Kit		
673-A0610		1/4-18 NPT Air Inlet Kit		
673-A0614		Endplate Bearing Kit		
673-A0063		Rotor, Vanes, Key Set		
673-A0398		3" Sander Rebuild Kit		
673-A0381		5" & 6" Sander Rebuild Kit		
673-A0311		3" x 4" Sander Rebuild Kit		
673-A0303		3-2/3" x 7" Sander Rebuild Kit		
673-A0479		Universal Service Toolkit		
673-A0910		Major Rebuild Tools		
673-A0711		Speed Valve Kit		
673-A1123		5" & 6" ROS Overhaul Kit		

Two-Hand Sander Parts

Model	NSN	Description	Weight lbs (kg)	Price
673-A2524		12,000 RPM Muffler for ROS		
673-A2528		Rotor, Vanes, Key Set		

① ROS = Random Orbital Sander, OS = Orbital Sander
 ★ Available on GSA Advantage website @ www.GSAadvantage.gov

Drop-In Motors

Quickly bring your sander back to top performance with this easy to install single piece drop-in motor.

- Requires Sander Rebuild Tools
- Installs in minutes
- Replaces all major wear items (bearing, rotors, vanes, etc.)



Drop-In Motors (Aluminum Sanders)

Model	NSN	Description	Weight lbs (kg)	Price
673-B0288		Drop-In Motor 3" x 3/32 orbit		
673-B0500		Drop-In Motor 3" x 3/16 orbit		
673-B0135		Drop-In Motor 5" x 3/16 orbit		
673-B0501		Drop-In Motor 5" x 5/16 orbit		
673-B0136		Drop-In Motor 6" x 3/16 orbit		
673-B0502		Drop-In Motor 6" x 5/16 orbit		

Drop-In Motors (Composite Sanders)

Model	NSN	Description	Weight lbs (kg)	Price
673-B0289		Drop-In Motor 3" x 3/32 orbit		
673-B0482		Drop-In Motor 3" x 3/16 orbit		
673-B0283		Drop-In Motor 5" x 3/16 orbit		
673-B0483		Drop-In Motor 5" x 5/16 orbit		
673-B0284		Drop-In Motor 6" x 3/16 orbit		
673-B0484		Drop-In Motor 6" x 5/16 orbit		

① Drop-In motors for our aluminum and composite sanders are **NOT** interchangeable. Installing the wrong drop-in motor will damage the sander and void your warranty.



Drop-In Motors (Two-Hand Sanders)

Model	NSN	Description	Weight lbs (kg)	Price
673-B0495		Drop-In Motor 5" x 3/16 orbit		
673-B0496		Drop-In Motor 5" x 3/8 orbit		
673-B0498		Drop-In Motor 6" x 3/16 orbit		
673-B0499		Drop-In Motor 6" x 3/8 orbit		



* Available on GSA Advantage website @ www.GSAadvantage.gov

Sander Rebuild & Repair

Sander & Drop-in Motor Rebuild & Repair

Clayton provides flat rate rebuild & repair of our sanders and sander air motors. Flat rate rebuild & repair services include:

- Rebuild entire sander – Replace any broken or worn parts including backup pad, rebuild air motor, test and certify
- Rebuild air motor only – Replace all major wear items, test, and certify

Please download the Sander Rebuild form from our website for pricing and additional details.

Sander & Motor Rebuild

Model	NSN	Size	Price
995-200		OS & ROS Sander Rebuild	
995-201		OS & ROS Air Motor Rebuild	
995-205		Two Hand Sander Rebuild	

- ★ Available on GSA Advantage website @ www.GSAadvantage.gov
- ▲ This item has an NSN - See Model / NSN table on page 4.

A = Always Replaced

B = Replaced if Needed

X = If damaged, the sander is Not Repairable

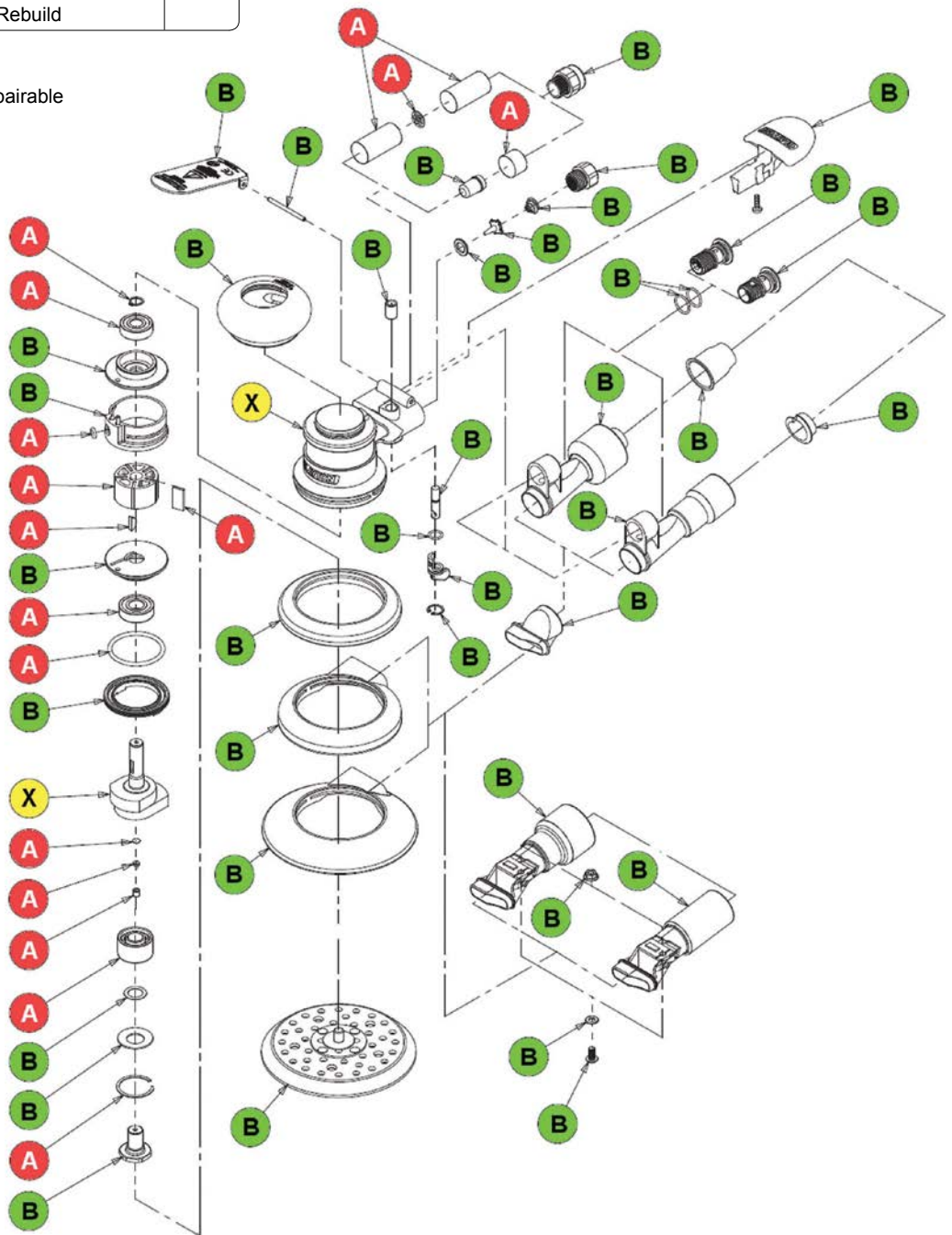

UNIVERSAL SHROUDS & SHROUDED TOOLS

Grinding • Cutting • Drilling • Routing



Announcing Tool Independence!

The Clayton Universal Shroud is a paradigm shift in shroud design. Historically, a dust control shroud was attached to the tool body and designed to fit a single make or model tool.

Our Universal Shrouds float on a bearing mounted to a ¼" mandrel. This means that a single Clayton Universal Shroud will fit ANY make or model tool with a ¼" collet. Use an existing tool you already have in your crib, or choose from any of the grinders that Clayton has to offer.

The Universal Shrouds dramatically decrease your Total Cost of Ownership (TCO) because they can be easily moved from one tool to another. Straight or right angle, Dotco or Dynabrade, etc. As your preferred tool manufacturer changes, Clayton Universal Shrouds can continue to provide the same outstanding performance year after year.

1", 2" & 3" Right Angle Sander Shrouds (sold with or without grinder)



Made of crystal clear Lexan, this is the future of shroud design. Built from the same material as aerospace cockpits, NASCAR windshields, and space helmets, it's virtually indestructible and guaranteed for life. This shroud does not obscure the working edges of the abrasive discs, so users can easily see the work surface.

Every shroud includes: mandrel, disc pad, 2' x 1" hose whip, and swivel adapter for connection to 1" vacuum hoses. Refer to hose and fitting section for other hose adapters.

Features

- Virtually indestructible Lexan is guaranteed for life
- Shroud does not obscure visibility
- Shroud swivels freely around mandrel, so the hose can be repositioned with ease
- Works with the grinders you already own - **NO MODIFICATIONS REQUIRED**
- Built-in Positive Lock swivel hose fitting – hoses won't pull free
- Recommended tool speed: 12,000 RPM – Max tool speed: 20,000 RPM
- Patented design maximizes dust capture



Clear Revolution Shroud
1 Inch



Clear Revolution Shroud
2 Inch



Clear Revolution Shroud
3 Inch

Lexan polycarbonate shroud is virtually indestructible



Crystal clear window for 225° of visibility



High flow 1" swivel hose connection for maximum dust extraction





1", 2" & 3" Right Angle Sander Shrouds (sold with or without grinder)

Clear Revolution 1" Right Angle Grinder Shroud (25mm)

Model	NSN	Pad	Abrasive Style	Weight lbs (kg)	Price
674-A1216TR		TR		-	
674-A1216TS		TS		-	
674-A1216TP		TP		-	



Clear Revolution 2" Right Angle Grinder Shroud (50mm)

Model	NSN	Pad	Abrasive Style	Weight lbs (kg)	Price
674-A1232TR	4130-01-460-4048	TR		-	
674-A1232TS		TS		-	
674-A1232TP	4130-01-459-8280	TP		-	



Clear Revolution 3" Right Angle Grinder Shroud (76mm)

Model	NSN	Pad	Abrasive Style	Weight lbs (kg)	Price
674-A1248TR		TR		-	
674-A1248TS		TS		-	
674-A1248TP	4130-01-459-8287	TP		-	



Clear Revolution Shroud Parts

Model	NSN	Desc	Price
672-004R		Mandrel	
672-1016TR		1" Pad TR Style	
672-1016TS		1" Pad TS Style	
672-1016TP		1" Pad TP Style	
672-1032TR-09		2" Pad TR Style	
672-1032TS-09		2" Pad TS Style	
672-1032TP-06	4130-01-459-5177	2" Pad TP Style	
672-1048TR-12		3" Pad TR Style	
672-1048TS-12		3" Pad TS Style	
672-1048TP-06	4130-01-459-5212	3" Pad TP Style	
674-A1216B		Bearing Replacement 1"	
674-A1232B		Bearing Replacement 2"	
674-A1248B		Bearing Replacement 3"	



Please call for other Tool & Shroud combinations that may be available.

For optimum dust extraction use Clayton ventilated abrasive discs or surface prep discs. All have holes for improved dust removal. Available in both TR and TS connection types.

*Bearing Replacement requires return to factory

MANDREL OPTIONS

- Shrouds with a 674- prefix have a 1/4in mandrel
- For Metric Size Mandrels Replace 674- with 774- and append suffix below

MODEL SUFFIX	MANDREL SIZE	COLLET SIZE
-48S	4.8MM SHORT	4.8MM
-48L	4.8MM LONG	4.8MM
-49S	4.95MM SHORT	4.95MM
-49L	4.95MM LONG	4.95MM
-60S	6MM SHORT	6MM
-60L	6MM LONG	6MM

⚠ Never exceed the maximum operating speed of your abrasive.
 ★ Available on GSA Advantage website @ www.GSAadvantage.gov



Call 732-363-2100 / 800 248-8650 or Order 24 hours a day from our website @ www.JClayton.com



1", 2" & 3" Right Angle Sander Shrouds (sold with or without grinder)



Made of machined aluminum, and guaranteed for life. This shroud does not obscure the working edges of the abrasive discs, so users can easily see the work surface.

Every shroud includes: mandrel, disc pad, 2' x 1" hose whip, and cuff for connection to 1" vacuum hoses. Refer to hose and fitting section for other hose adapters.

Features

- Shroud does not obscure visibility
- Shroud swivels freely around mandrel, so the hose can be repositioned with ease
- Works with the grinders you already own - NO MODIFICATIONS REQUIRED
- Recommended tool speed: 12,000 RPM – Max tool speed: 20,000 RPM
- Patented design maximizes dust capture



Aluminum Revolution 2" Shroud



Aluminum Revolution 3" Shroud





2" & 3" Right Angle Sander Shrouds (sold with or without grinder)

Aluminum Revolution 2" Right Angle Grinder Shroud (50mm)

Model	NSN	Pad	Abrasive Style	Weight lbs (kg)	Price
674-A1032TR		TR		-	
674-A1032TS		TS		-	
674-A1032TP	4130-01-459-8270	TP		-	



Aluminum Revolution 3" Right Angle Grinder Shroud (75mm)

Model	NSN	Pad	Abrasive Style	Weight lbs (kg)	Price
674-A1048TR		TR		-	
674-A1048TS		TS		-	
674-A1048TP	4130-01-459-8274	TP		-	



Clear Revolution Shroud Parts

Model	NSN	Desc	Price
672-004S		Mandrel	
672-1016TR		1" Pad TR Style	
672-1016TS		1" Pad TS Style	
672-1016TP		1" Pad TP Style	
672-1032TR-09		2" Pad TR Style	
672-1032TS-09		2" Pad TS Style	
672-1032TP-06	4130-01-459-5177	2" Pad TP Style	
672-1048TR-12		3" Pad TR Style	
672-1048TS-12		3" Pad TS Style	
672-1048TP-06	4130-01-459-5212	3" Pad TP Style	
674-A1216B		Bearing Replacement 1"	
674-A1232B		Bearing Replacement 2"	
674-A1248B		Bearing Replacement 3"	



Please call for other Tool & Shroud combinations that may be available.

For optimum dust extraction use Clayton ventilated abrasive discs or surface prep discs. All have holes for improved dust removal. Available in both TR and TS connection types.

*Bearing Replacement requires return to factory

MANDREL OPTIONS

- Shrouds with a 674- prefix have a 1/4in mandrel
- For Metric Size Mandrels Replace 674- with 774- and append suffix below

MODEL SUFFIX	MANDREL SIZE	COLLET SIZE
-48S	4.8MM SHORT	4.8MM
-48L	4.8MM LONG	4.8MM
-49S	4.95MM SHORT	4.95MM
-49L	4.95MM LONG	4.95MM
-60S	6MM SHORT	6MM
-60L	6MM LONG	6MM

Cartridge Roll Shroud (sold with or without grinder)



Cartridge rolls are ideal for getting into small, hard to reach areas. As they wear, the wrapped layers of the cartridge roll continuously expose fresh abrasive layers for continual cutting action.

Every shroud includes: mandrel, 2' x 1" hose whip, and swivel adapter for connection to 1" vacuum hoses. Refer to hose and fitting section for other hose adapters.

Features

- Mandrel Pilot 1" x 1/8" – Tapers from 1/8" to 1/4" over 3/4"
- Supports cartridge rolls < 1" D x 1 1/2" L x 1/8" ID
- Fits ANY tool with a 1/4" collet – Straight or right angle sanders, grinders, routers, etc.
- Virtually indestructible Lexan is guaranteed for life
- Shroud does not obscure visibility
- Shroud swivels freely around mandrel, so the hose can be repositioned with ease
- Works with the grinders you already own - NO MODIFICATIONS REQUIRED
- Built-in Positive Lock swivel hose fitting – hoses won't pull free



Please call for other Tool & Shroud combinations that may be available.

Cartridge Roll Shroud

Model	NSN	Grinder	Orientation	Motor RPM	Motor HP (W)	Air Inlet ID inch (mm)	Weight lbs (kg)	Price
674-A1216CR		Not Included	-	-	-	-	-	
674-A1216CR-02R		Dotco 12L1280-36	Right Angle	12,000	0.3 (220)	1/4"	1.1 (0.5)	
672-A015		Replacement Cartridge Roll Mandrel with Clips						

⚠ Never exceed the maximum operating speed of your abrasive.
 * Available on GSA Advantage website @ www.GSAadvantage.gov



Seat Track Cleaning Shroud

Aircraft seat tracks are notoriously difficult to clean and typically consume large numbers of small abrasive discs.

The Clayton Clear Revolution shroud for seat track cleaning and corrosion removal allows users to quickly change abrasives without wrenches or other tools.

Every shroud includes: mandrel, 2' x 1" hose whip, and swivel adapter for connection to 1" vacuum hoses. Refer to hose and fitting section for other hose adapters.

Features

- Works with either Clayton 3/4" cotton fiber abrasives.
- Fits ANY tool with a 1/4" collet – Straight or right angle sanders, grinders, routers, etc.
- Virtually indestructible Lexan is guaranteed for life
- Shroud does not obscure visibility
- Shroud swivels freely around mandrel, so the hose can be repositioned with ease
- Works with the grinders you already own - NO MODIFICATIONS REQUIRED
- Built-in Positive Lock swivel hose fitting – hoses won't pull free



Fits straight or right angle grinders with collets



Mounted point on 1" shroud

Seat track shroud for cotton fiber abrasives includes one abrasive.

Please call for other Tool & Shroud combinations that may be available.

Clear Revolution Seat Track Shrouds

Model	NSN	Desc	Weight lbs (kg)	Price
674-A1216CF	1680-01-641-7585	1" Seat Track Shroud for Cotton Fiber Abrasive		
800-12054C-50	5130-01-641-7594	Cotton Fiber Seat Track Disc 50 Pack		

Clear Revolution Seat Track Shrouds with Grinder

Model	NSN	Grinder	Pad	Abrasive Style	Orientation	Motor RPM	Motor HP (W)	Air Inlet ID inch (mm)	Weight lbs (kg)	Price
674-A1216CF-02R		Dotco 12LF280-36	1/4-20	CF	Right Angle	12000	0.4 (298)	1/4"	1.1 (0.5)	

⚠ Never exceed the maximum operating speed of your abrasive.
 ★ Available on GSA Advantage website @ www.GSAadvantage.gov

Edge Finishing & Deburring Shroud (sold with or without grinder)



When finishing and deburring panel edges, the abrasive and shroud are typically perpendicular to the panel surface. This makes it difficult to collect the debris.

Our Edge Finishing Shroud has a skirt that surrounds the abrasive to physically contain the debris and effectively capture it.

Every shroud includes: mandrel, disc pad, 2' x 1" hose whip and swivel adapter for connection to 1" vacuum hoses. Refer to hose and fitting section for other hose adapters.

Features

- Fits ANY tool with a 1/4" collet – straight or right angle sanders, grinders, routers, etc.
- Virtually indestructible Lexan is guaranteed for life
- Shroud does not obscure visibility
- Shroud swivels freely around shaft, so the hose can be repositioned with ease
- Works with the grinders you already own - NO MODIFICATIONS REQUIRED
- Positive Lock hose fitting – hoses won't pull free
- Recommended tool speed: 12,000 - 20,000 RPM
- Max tool speed: 25,000 RPM

Center Slot Shroud has a notch to accommodate inside corners



Uses 2" TR/TS abrasive discs



Side Slot Shroud



Center Slot Shroud



Available in:



Edge Trimmer and Deburring Shroud

Model	NSN	Description	Weight lbs (kg)	Price
674-A1248ETR		Edge Trimmer Shroud Kit TR Center & Side Slot		
674-A1248ETS		Edge Trimmer Shroud Kit TS Center & Side Slot		
674-A1248ETP		Edge Trimmer Shroud Kit TP Center & Side Slot		



MANDREL OPTIONS

- Shrouds with a 674- prefix have a 1/4in mandrel
- For Metric Size Mandrels Replace 674- with 774- and append suffix below

MODEL SUFFIX	MANDREL SIZE	COLLET SIZE
-60L	6MM LONG	6MM

⚠ Never exceed the maximum operating speed of your abrasive.
 ★ Available on GSA Advantage website @ www.GSAadvantage.gov



Call 732-363-2100 / 800 248-8650 or Order 24 hours a day from our website @ www.JClayton.com





Universal Cutoff Saw Shrouds (sold with or without grinder)

A grip on the top of the shroud aids in precise cuts. This puts your control above and in line with the cutting edge, making the tool much easier to control and more ergonomic. In addition, the grinder and shroud pivot independently, keeping the shroud flat on the work surface while the grinder pivots with your hand.

Every shroud includes: mandrel, 2' x 1" hose whip, and swivel adapter for connection to 1" vacuum hose. Refer to hose and fitting section for other hose adapters.

Features

- Fits ANY tool with a 1/4" collet – straight or right angle sanders, grinders, etc.
- Accepts discs with 1/4" arbor hole
- Precision finished anodized aluminum housing
- Positive Lock hose fitting – hoses won't pull free
- Built in depth control with graduation marks, provides precise adjustment
- Ergonomic comfort grip molded into shroud
- Works with the grinders you already own - NO MODIFICATIONS REQUIRED
- Recommended tool speed: 20,000 - 23,000 RPM – Max tool speed: 25,000 RPM



2" Universal Cutoff Saw Shroud (50mm)

Model	NSN	Grinder	Orientation	Motor RPM	Motor HP (W)	Air Inlet ID inch (mm)	Weight lbs (kg)	Price
674-A2032		Not Included	-	-	-	-	-	
690-72032-01R		Dotco 12L1281-36	Right Angle	20,000	0.3	1/4"		
690-72032-01S		Dotco 12L2580-01	Straight	23,000	0.9	1/4"		

3" Universal Cutoff Saw Shroud (75mm)

Model	NSN	Grinder	Orientation	Motor RPM	Motor HP (W)	Air Inlet ID inch (mm)	Weight lbs (kg)	Price
674-A2048		Not Included	-	-	-	-	-	
690-72048-01R		Dotco 12L1281-36	Right Angle	20,000	0.3	1/4"		
690-72048-01S		Dotco 12L2580-01	Straight	23,000	0.9	1/4"		



Please call for other Tool & Shroud combinations that may be available.

⚠ Never exceed the maximum operating speed of your abrasive.
 ★ Available on GSA Advantage website @ www.GSAadvantage.gov



Universal Radial Shrouds (sold with or without grinder)

Designed for 3M Bristle Discs or cut off wheels, this shroud does not obscure the working edge of the abrasive, so users can easily see the work surface.

Every shroud includes: mandrel, 2' x 1" hose whip and swivel adapter for connection to 1" vacuum hoses. Refer to hose and fitting section for other hose adapters.

Features

- Fits ANY tool with a 1/4" collet – straight or right angle sanders, grinders, routers, etc.
- Shroud does not obscure visibility
- Shroud swivels freely around shaft, so the hose can be repositioned with ease
- Works with the grinders you already own, up to 25,000 rpm - NO MODIFICATIONS REQUIRED
- Positive Lock hose fitting – hoses won't pull free
- Accepts up to 4 bristle discs with 3/8" center hole



3" Radial Shroud Narrow (1-2 bristle discs or 1 cutoff wheel 75mm)

Model	NSN	Grinder	Orientation	Motor RPM	Motor HP (W)	Air Inlet ID inch (mm)	Weight lbs (kg)	Price
674-A1648		Not Included	-	-	-	-	-	
674-A1648-02R		Dotco 12L1280-36	Right Angle	12,000	0.3 (220)	1/4"	1.1 (0.5)	
674-A1648-03S		Dotco 12L2082-01	Straight	18,000	0.6 (448)	1/4"	1.4 (0.6)	

3" Radial Shroud Wide (2-4 bristle discs 75mm)

Model	NSN	Grinder	Orientation	Motor RPM	Motor HP (W)	Air Inlet ID inch (mm)	Weight lbs (kg)	Price
674-A2148		Not Included	-	-	-	-	-	
674-A2148-02R		Dotco 12L1280-36	Right Angle	12,000	0.3 (220)	1/4"	1.1 (0.5)	
674-A2148-03S		Dotco 12L2082-01	Straight	18,000	0.6 (448)	1/4"	1.4 (0.6)	



4" Radial Shroud Narrow (1 cutoff wheel 100mm)

Model	NSN	Grinder	Orientation	Motor RPM	Motor HP (W)	Air Inlet ID inch (mm)	Weight lbs (kg)	Price
674-A1664		Not Included	-	-	-	-	-	
674-A1664-02R		Dotco 12L1280-36	Right Angle	12,000	0.3 (220)	1/4"	1.1 (0.5)	
674-A1664-03S		Dotco 12L2082-01	Straight	18,000	0.6 (448)	1/4"	1.4 (0.6)	

⚠ Never exceed the maximum operating speed of your abrasive.

* Available on GSA Advantage website @ www.GSAadvantage.gov

Drum Sander Shroud (sold with or without grinder)



Every shroud includes: mandrel, drum 2' x 1" hose whip, and swivel adapter for connection to 1" vacuum hoses. Refer to hose and fitting section for other hose adapters.

Features

- Fits ANY tool with a 1/4" collet – straight or right angle sanders, grinders, routers, etc.
- Virtually indestructible Lexan is guaranteed for life
- Shroud does not obscure visibility
- Shroud swivels freely around shaft, so the hose can be repositioned with ease
- Works with the grinders you already own - NO MODIFICATIONS REQUIRED
- Positive Lock hose fitting – hoses won't pull free
- Recommended tool speed: 12,000 RPM



Drum Sander Shrouds

Model	NSN	Description	Weight lbs (kg)	Price
674-A6016D08		Drum Sander Shroud 1in x 1/2	-	
674-A6016D10		Drum Sander Shroud 1in x 5/8		
674-A6016D12		Drum Sander Shroud 1in x 3/4		
674-A6016D16		Drum Sander Shroud 1in x 1in		

Radial Sander Shrouds

Model	NSN	Description	Weight lbs (kg)	Price
674-A6016D20		Drum Sander Shroud 1in x 1 1/4	-	
674-A6016D24		Drum Sander Shroud 1in x 1 1/2		
674-A6016D32		Drum Sander Shroud 1in x 2		

MANDREL OPTIONS

- Shrouds with a 674- prefix have a 1/4in mandrel
- For Metric Size Mandrels Replace 674- with 774- and append suffix below

MODEL SUFFIX	MANDREL SIZE	COLLET SIZE
-60L	6MM LONG	6MM

⚠ Never exceed the maximum operating speed of your abrasive.
 ★ Available on GSA Advantage website @ www.GSAadvantage.gov

Piloted Bonding Brush Shrouds - One Piece Metal Brush



Pilot Bonding Brushes are recommended for cleaning paint, primer, and corrosion around rivet holes. This ensures a positive electrical contact to eliminate static electricity. The brushes feature tightly spaced metal bristles which remove material at a consistent rate and still maintain a long life. Brushes are available in various pilot diameters and overall diameters to meet the needs of just about any application.

Tight Access shroud includes: mandrel, 2' x 3/4" hose whip and swivel adapter for connection to 1" vacuum hoses.

Clear Revolution shroud includes: mandrel, 2' x 1" hose whip and swivel adapter for connection to 1" vacuum hoses. Refer to hose and fitting section for other hose adapters.

Features

- Fits ANY tool that accepts the mandrel options listed below
- Straight or right angle sanders, grinders, routers, etc.
- Shroud swivels freely around mandrel
- Works with the tools you already own
- Built-in Positive Lock swivel hose fitting



MANDREL OPTIONS

- Not applicable to Tight Access Shroud
- Clear Revolution Shrouds with a 674- prefix have a 1/4in mandrel
- For Metric Size Mandrels Replace 674- with 774- and append suffix below

Piloted Bonding Brush Shroud ONLY

Model	NSN	Description	Price
674-A1113PT		Tight Access Notched Piloted Bonding Shroud 1/8in Mandrel	
674-A1114PT		Tight Access Piloted Bonding Shroud 1/8in Mandrel	
674-A1216PT		Clear Rev Piloted Bonding Shroud	
674-A1232PT		Clear Rev Piloted Bonding Shroud 2in	

MODEL SUFFIX	MANDREL SIZE	COLLET SIZE
-48S	4.8MM SHORT	4.8MM
-48L	4.8MM LONG	4.8MM
-60S	6MM SHORT	6MM
-60L	6MM LONG	6MM

Please call for a complete list of available brush diameters and pilot tip diameters.



Call 732-363-2100 / 800 248-8650 or Order 24 hours a day from our website @ www.JClayton.com





Piloted Bonding Abrasive Shrouds - 4 Piece System

Pilot Bonding Abrasives are recommended for cleaning paint, primer, and corrosion around rivet holes. This ensures a positive electrical contact to eliminate static electricity. Abrasives are available in various pilot diameters and overall diameters to meet the needs of just about any application.

Shrouds includes: mandrel, hose whip, and swivel adapter for connection to vacuum hoses. Pilot Tip, Friction Pad, and Abrasives sold separately.

Features

- Fits ANY tool that accepts the mandrel options listed below
- Straight or right angle sanders, grinders, routers, etc.
- Shroud swivels freely around mandrel
- Works with the tools you already own
- Built-in Positive Lock swivel hose fitting



Step 1 – Select the Shroud

Select the Shroud based on the Abrasive OD Size.



Tight Access Notched
1/8in Mandrel
Abrasives up to 1/2" OD

674-A1113PT



Front View



Tight Access Shroud
1/8in Mandrel
Abrasives up to 1/2" OD

674-A1114PT



Front View



1" Clear Revolution Shroud
Mandrel Options Below
Abrasives up to 3/4" OD

674-A1216PT



Front View

Piloted Bonding Abrasive Shroud ONLY

Model	NSN	Description	Price
674-A1113PT		Tight Access Notched Piloted Bonding Shroud 1/8in Mandrel	
674-A1114PT		Tight Access Piloted Bonding Shroud 1/8in Mandrel	
674-A1216PT		Clear Rev Piloted Bonding Shroud	

MANDREL OPTIONS

- Not applicable to Tight Access Shroud
- Shrouds with a 674- prefix have a 1/4in mandrel
- For Metric Size Mandrels Replace 674- with 774- and append suffix below

MODEL SUFFIX	MANDREL SIZE	COLLET SIZE
-48S	4.8MM SHORT	4.8MM
-48L	4.8MM LONG	4.8MM
-60S	6MM SHORT	6MM
-60L	6MM LONG	6MM

Please call for a complete list of available brush diameters and pilot tip diameters.



Call 732-363-2100 / 800 248-8650 or Order 24 hours a day from our website @ www.JClayton.com



Step 2 – Select the Pilot

Select the Pilot Tip based on the Abrasive OD and Hole Size.



Pilot Tips for 1/2in OD Abrasive



Item No	Desc	Pilot Diameter
672-08PE083-098	Hole Size #40 (.0980in) (2.49mm)	0.0830
672-08PE110-125	Hole Size 1/8in (.1250in) (3.175mm)	0.1100
672-08PE113-128	Hole Size #30 (.1285in) (3.26mm)	0.1135
672-08PE141-156	Hole Size 5/32 in, (.1563in) (3.97 mm)	0.1413
672-08PE144-159	Hole Size #21 (.1590in) (4.04mm)	0.1440
672-08PE172-187	Hole Size 3/16in (.1875in) (4.76mm)	0.1725
672-08PE178-193	Hole Size #10 (.1935in) (4.91mm)	0.1785
672-08PE203-218	Hole Size 7/32 (.2188in) (5.56mm)	0.2038
672-08PE235-250	Hole Size 1/4in (.2500in) (6.35mm)	0.2350

Pilot Tips for 5/8in & 3/4in OD Abrasive



Item No	Desc	Pilot Diameter
672-12PE083-098	hole size #40 (.0980in) (2.49mm)	0.0830
672-12PE110-125	hole size 1/8in (.1250in) (3.175mm)	0.1100
672-12PE113-128	hole size #30 (.1285in) (3.26mm)	0.1135
672-12PE141-156	hole size 5/32 in, (.1563in) (3.97 mm)	0.1413
672-12PE144-159	hole size #21 (.1590in) (4.04mm)	0.1440
672-12PE172-187	hole size 3/16in (.1875in) (4.76mm)	0.1725
672-12PE178-193	hole size #10 (.1935in) (4.91mm)	0.1785
672-12PE203-218	hole size 7/32 (.2188in) (5.56mm)	0.2038
672-12PE235-250	hole size 1/4in (.2500in) (6.35mm)	0.2350
672-12PE297-312	hole size 5/16in (.3125in) (7.94mm)	0.2975
672-12PE360-375	hole size 3/8in (.3750in) (9.52mm)	0.3600

Step 3 – Select the Friction Pad

Select the Friction Pad based on the Abrasive OD and Hole Diameter.

Friction Pads 10 pk for 1/2in OD Abrasive



Item No	Hole Diameter	
	From	To
672-0802FP-1	0.0775	0.1087
672-0802FP-2	0.1088	0.1399
672-0802FP-3	0.1400	0.1712
672-0802FP-4	0.1713	0.2024
672-0802FP-5	0.2025	0.2337
672-0802FP-6	0.2338	0.2649
672-0802FP-7	0.2650	0.2962

Friction Pads 10 pk for 5/8in & 3/4in OD Abrasive



Item No	Hole Diameter	
	From	To
672-1202FP-1	0.0775	0.1087
672-1202FP-2	0.1088	0.1399
672-1202FP-3	0.1400	0.1712
672-1202FP-4	0.1713	0.2024
672-1202FP-5	0.2025	0.2337
672-1202FP-6	0.2338	0.2649
672-1202FP-7	0.2650	0.2962
672-1202FP-8	0.2963	0.3274
672-1202FP-9	0.3275	0.3587
672-1202FP-10	0.3588	0.3899
672-1202FP-11	0.3900	0.4212



Step 4 – Select the Abrasive

Select the Abrasive based on the Abrasive OD, Abrasive Grit, and Hole Diameter.

Abrasive
1/2in OD (100 pk)



Item No	Grit	Hole Diameter	
		From	To
800-08P-4-003	Crs		
800-08P-4-006	Med	0.0931	0.1087
800-08P-4-009	Fine		
800-08P-5-003	Crs		
800-08P-5-006	Med	0.1088	0.1243
800-08P-5-009	Fine		
800-08P-6-003	Crs		
800-08P-6-006	Med	0.1244	0.1399
800-08P-6-009	Fine		
800-08P-7-003	Crs		
800-08P-7-006	Med	0.1400	0.1555
800-08P-7-009	Fine		
800-08P-8-003	Crs		
800-08P-8-006	Med	0.1556	0.1712
800-08P-8-009	Fine		
800-08P-9-003	Crs		
800-08P-9-006	Med	0.1713	0.1868
800-08P-9-009	Fine		
800-08P-10-003	Crs		
800-08P-10-006	Med	0.1869	0.2024
800-08P-10-009	Fine		
800-08P-11-003	Crs		
800-08P-11-006	Med	0.2025	0.2180
800-08P-11-009	Fine		
800-08P-12-003	Crs		
800-08P-12-006	Med	0.2181	0.2337
800-08P-12-009	Fine		
800-08P-13-003	Crs		
800-08P-13-006	Med	0.2338	0.2493
800-08P-13-009	Fine		
800-08P-14-003	Crs		
800-08P-14-006	Med	0.2494	0.2649
800-08P-14-009	Fine		

Abrasive
5/8in OD (100 pk)



Item No	Grit	Hole Diameter	
		From	To
800-10P-4-003	Crs		
800-10P-4-006	Med	0.0931	0.1087
800-10P-4-009	Fine		
800-10P-5-003	Crs		
800-10P-5-006	Med	0.1088	0.1243
800-10P-5-009	Fine		
800-10P-6-003	Crs		
800-10P-6-006	Med	0.1244	0.1399
800-10P-6-009	Fine		
800-10P-7-003	Crs		
800-10P-7-006	Med	0.1400	0.1555
800-10P-7-009	Fine		
800-10P-8-003	Crs		
800-10P-8-006	Med	0.1556	0.1712
800-10P-8-009	Fine		
800-10P-9-003	Crs		
800-10P-9-006	Med	0.1713	0.1868
800-10P-9-009	Fine		
800-10P-10-003	Crs		
800-10P-10-006	Med	0.1869	0.2024
800-10P-10-009	Fine		
800-10P-11-003	Crs		
800-10P-11-006	Med	0.2025	0.2180
800-10P-11-009	Fine		
800-10P-12-003	Crs		
800-10P-12-006	Med	0.2181	0.2337
800-10P-12-009	Fine		
800-10P-13-003	Crs		
800-10P-13-006	Med	0.2338	0.2493
800-10P-13-009	Fine		
800-10P-14-003	Crs		
800-10P-14-006	Med	0.2494	0.2649
800-10P-14-009	Fine		

Abrasive
3/4in OD (100 pk)



Item No	Grit	Hole Diameter	
		From	To
800-12P-4-003	Crs		
800-12P-4-006	Med	0.0931	0.1087
800-12P-4-009	Fine		
800-12P-5-003	Crs		
800-12P-5-006	Med	0.1088	0.1243
800-12P-5-009	Fine		
800-12P-6-003	Crs		
800-12P-6-006	Med	0.1244	0.1399
800-12P-6-009	Fine		
800-12P-7-003	Crs		
800-12P-7-006	Med	0.1400	0.1555
800-12P-7-009	Fine		
800-12P-8-003	Crs		
800-12P-8-006	Med	0.1556	0.1712
800-12P-8-009	Fine		
800-12P-9-003	Crs		
800-12P-9-006	Med	0.1713	0.1868
800-12P-9-009	Fine		
800-12P-10-003	Crs		
800-12P-10-006	Med	0.1869	0.2024
800-12P-10-009	Fine		
800-12P-11-003	Crs		
800-12P-11-006	Med	0.2025	0.2180
800-12P-11-009	Fine		
800-12P-12-003	Crs		
800-12P-12-006	Med	0.2181	0.2337
800-12P-12-009	Fine		
800-12P-13-003	Crs		
800-12P-13-006	Med	0.2338	0.2493
800-12P-13-009	Fine		
800-12P-14-003	Crs		
800-12P-14-006	Med	0.2494	0.2649
800-12P-14-009	Fine		
800-12P-18-003	Crs		
800-12P-18-006	Med	0.3119	0.3274
800-12P-18-009	Fine		
800-12P-22-003	Crs		
800-12P-22-006	Med	0.3744	0.3899
800-12P-22-009	Fine		



Universal Drill Shroud (sold with or without drill)

This Universal Shroud design attaches between the drill and chuck and provides exceptional dust collection when used on composites or sheet metal. The shroud works with drill bits, reamers, and countersinks.

Every shroud includes: 1" x 2' vacuum hose whip, 2 interchangeable lexan tips, and swivel adapter for connection to 1" vacuum hoses. Refer to hose and fitting section for other hose adapters.

Features

- Fits non-reversing drills with a 3/8"-24 threaded chuck
- Precision finished anodized aluminum housing
- Crystal Clear Lexan shroud does not obscure visibility (includes 2 sizes)
- Works with the drills you already own, up to 25,000 rpm
- Works with microstop countersinks up to 1.70" OD
- Removable/Replaceable Lexan shroud
- Positive Lock hose fitting – hoses won't pull free
- Shroud swivels freely around chuck, so the hose can be repositioned
- Shroud self centers on drill bit without the need for any expensive bushings
- Built-in depth control



Please call for other Tool & Shroud combinations that may be available.



Universal Drill Shroud

Model	NSN	Chuck Size	Drill	Orientation	Motor RPM	Motor HP (W)	Air Inlet ID inch (mm)	Weight lbs (kg)	Price
674-A3005		-	Not Included	-	-	-	-	-	
690-73004-01		3/8"	Dotco 14CNL92-51	Pistol Grip	3,200	0.5 (373)	1/4"	2.5 (1.1)	
690-73004-02		3/8"	Dotco 14CSL95-51	Pistol Grip	1,300		1/4"		
690-73004-03		1/4"	Dotco 14CFS93-38	Pistol Grip	3,200		1/4"		
690-73004-04		3/8"	Dotco 14CSL92-51	Pistol Grip	3,200	0.6	1/4"		
690-73004-20		3/8"	Ingersoll Rand 728LA2	Pistol Grip	2,850	0.9 (670)	1/4"	2.4 (1.0)	

⚠ Never exceed the maximum operating speed of your abrasive.
 * Available on GSA Advantage website @ www.GSAadvantage.gov

Right Angle Drill Shroud

When it's time to make holes in tight spaces, the best tool for the job is the right angle drill. The drill's narrow stature gives it the ability to fit in tight quarters, but makes dust collection difficult. The Clayton drill shroud is a modular solution that can be easily clipped onto a drill to collect dust and chips while drilling. The base shroud collects from directly behind the bit, and optional attachments allow collection from the front or sides. The shroud can be easily removed for storage or to be moved to another tool.

Base shroud includes: 2' x 3/4" hose whip and swivel adapter for connection to 1" vacuum hoses.
 Base shroud is required for left, right and front attachments.

Refer to hose and fitting section for hose adapters.

Features

- Fits right angle drills with a 0.63" nominal shaft diameter
- Snaps on and off drill easily

Drill Shroud (Right Angle)

Model	NSN	Desc	Weight lbs (kg)	Price
674-A3010		Clip On Drill Shroud 5pc		
674-3010A		Clip on Drill Shroud Base only		
674-3010B		Clip on Drill Shroud Back Pickup only		
674-3010L		Clip on Drill Shroud Left Pickup only		
674-3010R		Clip on Drill Shroud Right Pickup only		
674-3010F		Clip on Drill Shroud Front Pickup only		
674-A3010-K1		Clip on Drill Shroud 5pc Boxed Kit		



Box Kit



Right Pickup



Back Pickup



Left Pickup



Front Pickup



Flexible FOD Wands

Our flexible FOD wands are made from clear Tygon tubing and come in multiple sizes. All terminate in 1in female hose thread and include a 1-1/4in smooth female adapter.

Flexible FOD Wands

Model	NSN	Desc	Price
500-512-0609		FOD Wand 3/8in (9mm) ID x 12in (30cm) Tygon Clear	
500-512-0912		FOD Wand 9/16in (15mm) ID x 12in (30cm) Tygon Clear	
500-524-1216		FOD Wand 3/4in (19mm) ID x 24in (60cm) Tygon Clear	
500-548-0609		FOD Wand 3/8in (9mm) ID x 48in (1.2m) Tygon Clear	
500-548-0912		FOD Wand 9/16in (15mm) ID x 48in (1.2m) Tygon Clear	

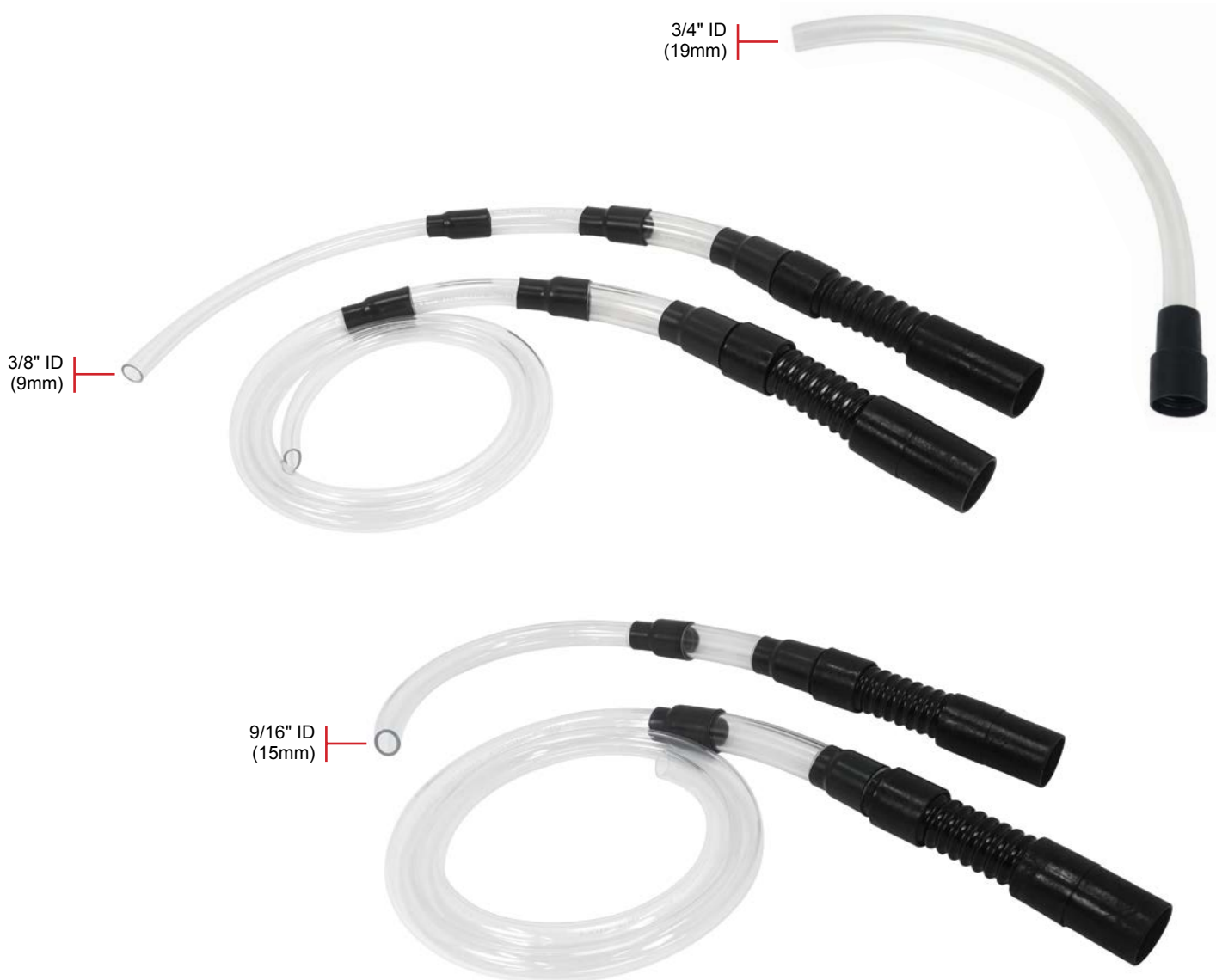

PRECISION DRILLS

Drilling Kits

Model	NSN	Desc	Price
690-800-0650		Air Drill 650 RPM 1/4in Keyless Chuck	
690-800-2000R		Air Drill 2000 RPM 1/4in Keyed Chuck Reversible	
690-800-2400		Air Drill 2400 RPM 1/4in Keyless Chuck	
690-800-3100R		Air Drill 3100 RPM 1/4in Keyed Chuck Reversible	
690-800-3200		Air Drill 3200 RPM 1/4in Keyless Chuck	
690-800-4000		Air Drill 4000 RPM 1/4in Keyless Chuck	

Six of the smoothest air drills you've ever used. The reversible drills feature a lockable thumb button reverse and precision keyed chuck. The non-reversible drills are available in low speed high torque, and high speed compact. Both are equipped with precision Rohm keyless chucks for fast and easy bit changes. All drills have adjustable directional exhaust, variable speed triggers, Hogue grips, and 1/4" air inlets.



Lockable Reverse Button



Precision Keyed 3/8" Chuck



Variable Speed Trigger



Directional Exhaust



Hogue Grip



Rohm Keyless 1/4" Chuck



2000 RPM Compact Reversible



3100 RPM Compact Reversible

REVERSIBLE KIT



650 RPM High Torque



2400 RPM High Torque

LOW SPEED KIT



3200 RPM Compact



4000 RPM Compact

HIGH SPEED KIT



Soft Drill Shrouds

Soft Drill Shrouds are a great way to collect dust, chips, and shavings from drilling operations. These flexible shrouds conform to flat and curved surfaces, and the suction from the vacuum keeps them in place so you can focus on the job. Just place the shroud on your work surface and turn on the vacuum. Drill through the middle of the shroud, and the peripheral holes will draw the dust and shavings into the vacuum. The smaller shroud covers holes up to 1.375" in diameter. The large shroud allows for a customizable opening, up to 4.0", for bigger bits, spade bits, and hole saws.

Features

- Works with any drill
- Clear shroud does not obscure visibility (includes 2 sizes)



Please call for other
Tool & Shroud
combinations that
may be available.



Soft Drill Shrouds

Model	NSN	Description	Weight lbs (kg)	Price
674-A3122	4130-01-460-4041	Soft Drill Shroud 1-3/8in ID		
674-A3164		Soft Drill Shroud 1in - 4in ID		

Drill Guides

Designed to replace your existing drill blocks and egg cups, our vacuum Drill Guides accept a variety of bushings to hold your drill bit perfectly perpendicular to your work surface. They contain and extract drilling debris including dust, chips and swarf with a high flow 1in vacuum hose connection.

Features

- Made of virtually indestructible crystal clear Lexan
- Includes 2ft of 1in vacuum hose and threaded 1in swivel cuff
- Slip Fixed Drill Guides accept any 1/2in OD Slip Fixed Bushings
- Threaded Drill Guides accept either 1/2-13 or 3/4-16 bushings depending on model
- Open Drill Shrouds provide a 3/4in opening for drilling without bushings.
- 2in Drill Guides will hold themselves on smooth vertical surfaces while vacuum source is active
- Requires a vacuum source sold separately
- Bushings sold separately



Drill Guides

Model	NSN	Bushing Type	Accepts Bushings	Shroud Diameter	Weight lbs (kg)	Price
674-A1316-08SF		Slip Fixed	1/2" OD	1"		
674-A1332-08SF		Slip Fixed	1/2" OD	2"		
674-A13XX-08SF	4130-01-502-1336	Slip Fixed	1/2" OD	1" & 2"		
674-A1316-08T		Threaded	1/2-13	1"		
674-A1332-08T		Threaded	1/2-13	2"		
674-A1316-12T		Threaded	3/4-16	1"		
674-A1332-12T		Threaded	3/4-16	2"		
674-A1316-12X		Open	None	1"		
674-A1332-12X		Open	None	2"		

⚠ Never exceed the maximum operating speed of your abrasive.

* Available on GSA Advantage website @ www.GSAadvantage.gov

The Microstop Countersink Shroud Kit & Individual Shrouds

Whether you're preparing carbon fiber, aluminum, or other panels, countersinks create a lot of dust, chips, and potentially hazardous debris and FOD. The Clayton clip-on countersink shrouds are designed to work with the cages you already own. They attach to different size cages, and allow you to vacuum away the debris from the work surface, reducing FOD and controlling potentially hazardous dust. The shrouds are available in a number of sizes to fit the outer diameter of a full range of microstop countersink cages. Just measure the OD of your cage, and select the shroud that fits your tool.

Microstop Countersink Shroud Kit

Model	NSN	Description	Weight lbs (kg)	Price
1535150	4130-01-459-8316	Microstop Clip On Shroud Kit, 12 PC		

Shroud Kit Includes

- 12 shrouds sizes .625in to 2in
- 2 vacuum hose adapters
- Magnetic quick disconnect
- Carry case



12pc Kit

Microstop Countersink Shrouds

Model	NSN	Description	Weight lbs (kg)	Price
674-MS10D11		Microstop Carbon Fiber Shroud for 0.625in Diameter		
674-MS12D13		Microstop Carbon Fiber Shroud for 0.75in Diameter		
674-MS14D15		Microstop Carbon Fiber Shroud for 0.875in Diameter		
674-MS16D17		Microstop Carbon Fiber Shroud for 1in Diameter		
674-MS18D19		Microstop Carbon Fiber Shroud for 1.125in Diameter		
674-MS20D21		Microstop Carbon Fiber Shroud for 1.25in Diameter		
674-MS22D23		Microstop Carbon Fiber Shroud for 1.375in Diameter		
674-MS24D25		Microstop Carbon Fiber Shroud for 1.5in Diameter		
674-MS26D27		Microstop Carbon Fiber Shroud for 1.625in Diameter		
674-MS28D29		Microstop Carbon Fiber Shroud for 1.75in Diameter		
674-MS30D31		Microstop Carbon Fiber Shroud for 1.875in Diameter		
674-MS32D33		Microstop Carbon Fiber Shroud for 2in Diameter		

Belt Sander Shroud (sold with or without Dotco sander)

Our Tool Specific Belt Sander Shroud complements a 12K RPM 6" x 1/2" Dotco belt sander.

The shroud does not obscure the working edges of the abrasive belt, so users can easily see the work surface and get into tight areas.

Every shroud includes: 2' x 1" hose whip and swivel adapter for connection to 1" vacuum hoses. Refer to hose and fitting section for other hose adapters.



Features

- Compact 6" arm accepts 1/2" x 12" belts
- Precision finished anodized aluminum housing
- Shroud does not obscure visibility
- Shroud swivels on tool with sander belt
- Positive Lock hose fitting – hoses won't pull free
- Abrasive belts available in standard grits and non-woven

1/2" Belt Sander Shroud for Dotco (13mm)

Model	NSN	Belt Size	Sander	Orientation	Motor RPM	Motor HP (W)	Air Inlet ID inch (mm)	Weight lbs (kg)	Price
674-A4008		-	Not Included	-	-	-	-	-	
674-A4008-02R	4130-01-460-8182	1/2" (12)	Dotco 12L1280-36B2		12,000	0.3 (220)	1/4"	1.4 (0.6)	

1/2" Belt Sander Shroud for Ingersoll Rand (model CA120RS812 or G1A120RS812)

Model	NSN	Belt Size	Sander	Orientation	Motor RPM	Motor HP (W)	Air Inlet ID inch (mm)	Weight lbs (kg)	Price
674-A4108		1/2" (12)	Not Included	-	-	-	-	-	

- ⚠ Never exceed the maximum operating speed of your abrasive.
- ★ Available on GSA Advantage website @ www.GSAadvantage.gov
- ⚡ This item has an NSN - See Model / NSN table on page 4.



Please call for other Tool & Shroud combinations that may be available.

Belt Sander Shroud (sold with or without Dynabrade sander)

Our Tool Specific Belt Sander Shroud complements a 1/2" x 6" Dynabrade belt sander.

The shroud does not obscure the working edges of the abrasive belt, so users can easily see the work surface and get into tight areas.

Every shroud includes: 2' x 1" hose whip and swivel adapter for connection to 1" vacuum hoses.

Features

- Compact 6" arm accepts 1/2" x 12" belts
- Precision finished anodized aluminum housing
- Shroud does not obscure visibility
- Shroud swivels on tool with sander belt
- Abrasive belts available in standard grits and non-woven

1/2" Belt Sander Shrouds

Model	Belt Size in (mm)	Sander	Motor RPM	Motor HP (W)	Weight lbs (kg)	Price
674-A4208	-	Shroud Only - Belt Sander NOT included Dynabrade Not Included	-	-	-	
674-A4208-10	1/2 (12)	Shroud with Mini-Dynaflex II	25,000	.4 (298)	1.7	



Shroud and Belt Sander

Shroud Only

⚠ Never exceed the maximum operating speed of your abrasive.



Dreamliner Repair Kit

The 787 Dreamer Kit is a collection of Boeing specified drill bits, reamers, and counter sinks for stringer and skin repair on the Boeing 787 Dreamliner. These are the same bits used at the Boeing training center for 787 repairs in Miami Florida. The kit also includes three drills with Boeing specified RPMs for the repair.

Features:

- 116 custom drill bits, reamers, pilot tips, and countersinks
- 3 Atlas Copco drills 500, 1000, and 6000 RPM
- Drills are equipped with Clayton dust & chip collection shrouds
- Shadow boxed tool control foam
- Chromacoded tubes for quick good / bad bit identification
- Packed in an indestructible Pelican case

116 custom drill bits, reamers, counter sinks and pilots



Chromacoded tubes for quick good / bad cutter identification
 Green Up – Cutter is good
 Red Up – Cutter is bad



787 Dreamer Kits

Model	Description	Weight lbs (kg)	Price
AMK-787AC-01	787 Dreamer Kit		

Clayton Shrouded Drills Included

Requires an external vacuum source for dust collection (not included)



Replacement Shrouded Drills

Qty	Model	Description
1	690-73004-40	Atlas Copco pistol drill LBB16 EPX 005 - 500 RPM
1	690-73004-41	Atlas Copco pistol drill LBB16 EPX 010 - 1000 RPM
1	690-73004-42	Atlas Copco pistol drill LBB16 EPX 060 - 6000 RPM



Replacement Cutting Tools

Qty	Model	Boeing Tool #	Description
24	BA-ST10-907	ST10-907-H-1285-1-44-24	#30 Solid Carbide Jobber Length Drill 135° Split Point (Per Boeing ST10-907A)
6	BA-ST1257B-1285	ST1257B-1285-600-1	0.1285X6" SS carbide dreamer Pilot drill Carbon (Dash 6)
6	BA-ST1257B-1900	ST1257B-1900-600-1	0.1900x6" SS carbide dreamer for -6 Hiloc, loc bolt or OSI
6	BA-ST1257B-1990	ST1257B-1990-600-1	0.1990x6" SS carbide dreamer for BACBVK or BACBVL -6 blind bolt
6	BA-ST1257B-2610	ST1257B-2610-600-1	0.2610X6" SS carbide dreamer Pilot drill Carbon (Dash 8)
6	BA-ST1864R19004	ST1864R-1900-1580-4-126-4-96-1-7	0.190x0.158x0.126" SS carbide step-reamer Step Ti and Carbon (Dash 6)
6	BA-ST1864R25004	ST1864R-2500-2200-4-190-4-96-1-7	0.250x0.220x0.190" SS carbide step-reamer Step Ti and Carbon (Dash 8)
6	BA-ST1864R31254	ST1864R-3125-2800-4-250-4-96-1-7	0.3125x0.280x0.190" SS carbide step-reamer Step Ti and Carbon (Dash 10)
3	BA-ST1223CD100	ST1223C-D-630-100-3	5/8" dia. Polycrystalline diamond coated 100° countersink use .125 shank pilots
3	BA-ST1223CD130	ST1223C-D-630-130-2	5/8" dia. Polycrystalline diamond coated 130° countersink use .125 shank pilots
10	BA-ST1223CDP190	ST1223C-DP-190-82-124	0.124 shank 0.190 diameter pilot for ST1223C cutter (Dash 6)
10	BA-ST1223CDP198	ST1223C-DP-198-82-124	0.124 shank 0.198 diameter pilot for ST1223C cutter (Dash 6)
10	BA-ST1223CDP248	ST1223C-DP-248-82-124	0.124 shank 0.248 diameter pilot for ST1223C cutter (Dash 8)
10	BA-ST1223CDP260	ST1223C-DP-260-82-124	0.124 shank 0.260 diameter pilot for ST1223C cutter (Dash 8)
10	BA-ST1223CDP312	ST1223C-DP-312-82-124	0.124 shank 0.312 diameter pilot for ST1223C cutter (Dash 10)

Router Shroud (sold with or without Dotco Router)

Our Tool Specific Router Shroud complements a 23K RPM 1¼" Dotco Router.

Every shroud kit includes: Standard Shroud, Spanner Shroud, Router Adapter Ring, 2' x 1" vacuum hose whip, and swivel adapter for connection to 1" vacuum hose. Refer to hose and fitting section for other hose adapters.

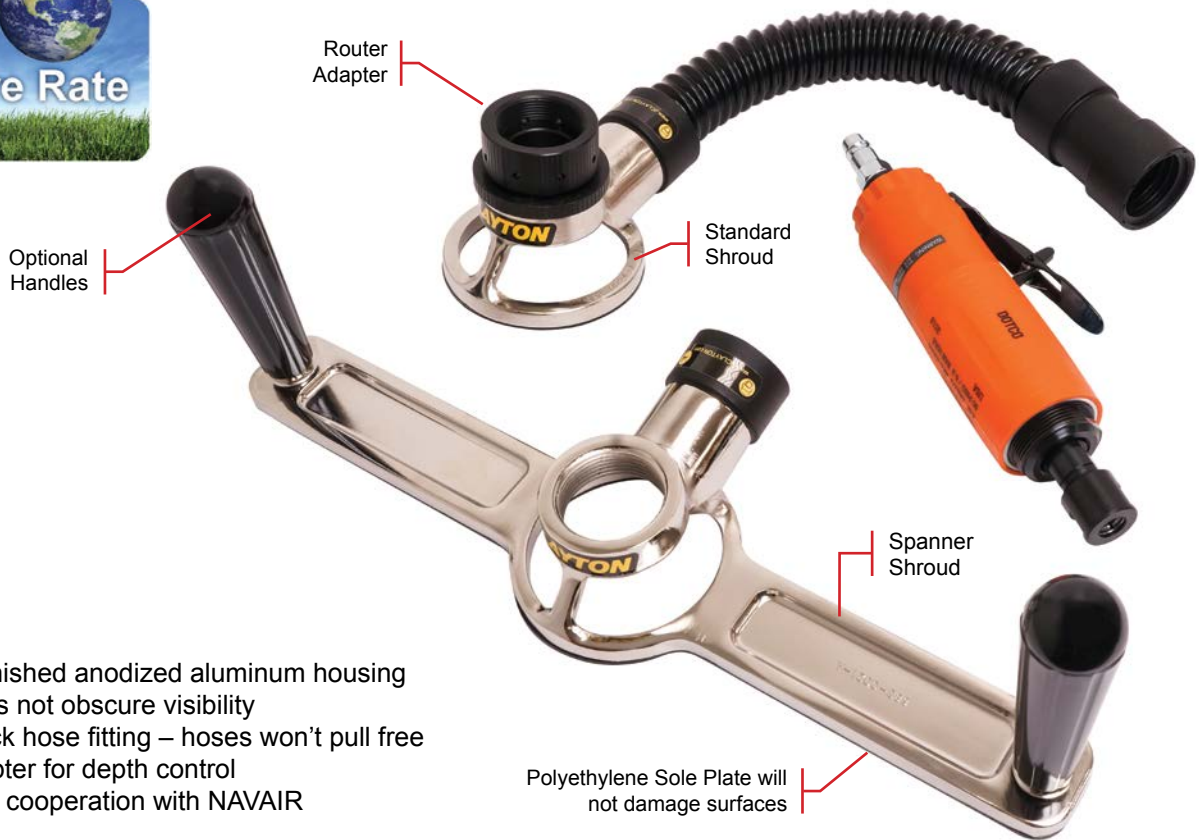

Features

- Precision finished anodized aluminum housing
- Shroud does not obscure visibility
- Positive Lock hose fitting – hoses won't pull free
- Router adapter for depth control
- Designed in cooperation with NAVAIR

Router Shroud

Model	NSN	Description	Grinder	Orientation	Motor RPM	Motor HP (W)	Air Inlet ID inch (mm)	Weight lbs (kg)	Price
674-A3201		Shroud & Spanner Kit	Not Included	-	-	-	-	-	
674-A3202		Shroud Kit	Not Included	-	-	-	-	-	
690-73201-01S		Router Shroud & Spanner Kit	Dotco 12L2580-01	Straight	23,000	0.9	1/4"		
690-73202		Router Shroud Kit	Dotco 12L2580-01	Straight	23,000	0.9	1/4"		

Router Shroud Replacement Parts

Model	NSN	Description	Weight lbs (kg)	Price
683-0022		Router Adapter Ring		
602-0024		Polyethylene Standard Sole Plate		
602-0021		Polyethylene Spanner Sole Plate		



Please call for other Tool & Shroud combinations that may be available.

* Available on GSA Advantage website @ www.GSAadvantage.gov



Inline Router (sold with or without Dotco Router)

The inline router provides the power and control needed for trimming and routing along fixtures. Carbon fiber, aluminum, and other substrates generate large amounts of airborne dust and pose a serious risk to workers and aerostructures. This router collects the airborne dust and helps to reduce the chips and debris. The shroud connects to a portable or central vacuum. This shrouded router is a standard in NAVAIR and USAF maintenance kits. The shroud is available alone or with a 0.9HP motor.



Features

- 2' x 1" vacuum hose whip
- Swivel adapter for connection to 1" hose.
- Positive Lock hose fitting – hoses won't pull free
- Depth Adjustment
- Router Guides & Skirt

Router Guides



1"OD
25/32"ID

3/4"OD
21/32"ID

5/8"OD
17/32"ID

1/2"OD
13/32"ID

7/16"OD
11/32"ID

3/8"OD
9/32"ID

5/16"OD
1/4"ID

2 Locking Nuts

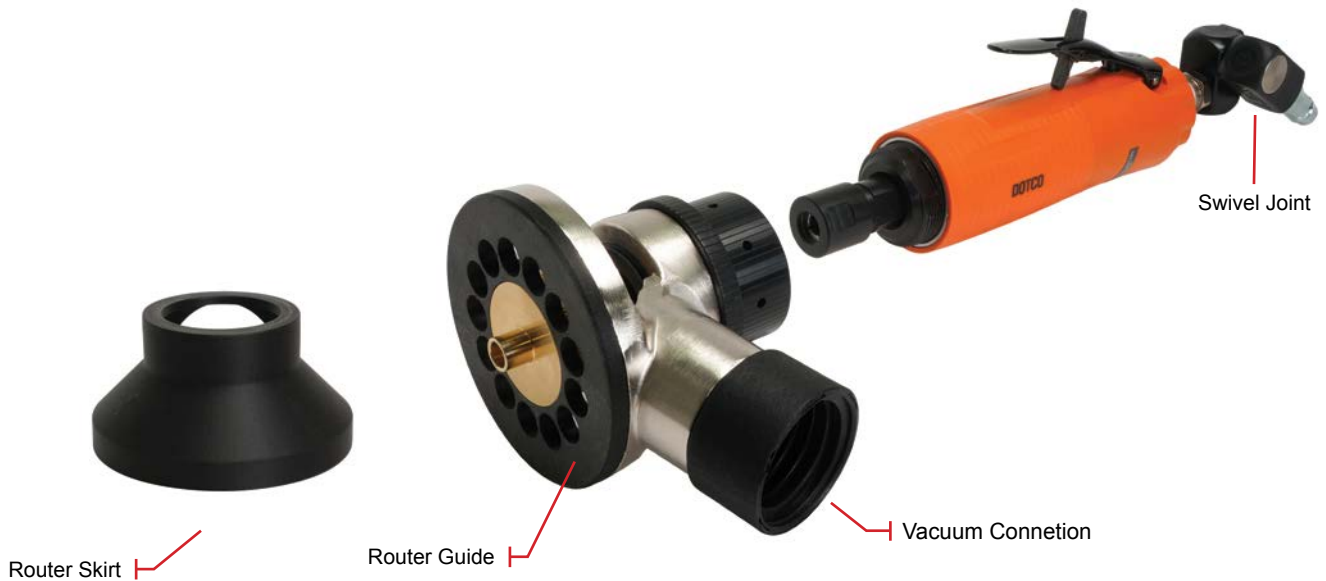

Inline Router Shroud

Model	NSN	Description	Price
674-A3250		Router Shroud (No Router)	
60083K	4130-01-459-1485	Router with Shroud 23K RPM 1/8in Guide	



Please call for other Tool & Shroud combinations that may be available.

⚠ Never exceed the maximum operating speed of your abrasive.
 ★ Available on GSA Advantage website @ www.GSAadvantage.gov

Pencil Grinder Kit

Straight 70K rpm and right angle 56K rpm pencil grinders include cases, carbide & stone grinding burrs, and clip on dust collection shrouds.



Scorpion kit includes both Pencil Grinders, Scorpion Pneumatic vac, hoses, and a rugged ballistic nylon tool bag.

Pencil Grinder Kit

Model	NSN	Description	Price
690-PG56KS-KIT		Pencil Grinder Straight 56K rpm Kit	
690-PG70KR-KIT		Pencil Grinder Right Angle 70K rpm Kit	
690-PGSR-01		Pencil Grinder Kit Straight/Right Angle/Scorpion	



Scorpion Vacuum with Straight Pen Grinder



70K rpm Right Angle Pencil Grinder



Front Pickup



Right Pickup



Left Pickup



56K rpm Straight Pen Grinder



Straight Pickup





Burrs

The first step in preparing components is heavy stock removal, and nothing handles that job better than a rotary file. Unfortunately, nothing makes a bigger mess than a rotary file. This innovative shroud is engineered to evacuate the airborne dust and debris from the work area while still allowing visibility and access to the tool.

Every shroud includes: mandrel, 2' x 1" hose whip, and swivel adapter for connection to 1" vacuum hoses. Refer to hose and fitting section for other hose adapters.

Features

- 1/2" and 3/4" threaded rotary files available separately
- Fits ANY tool with a 1/4" collet – Straight or right angle grinders, drills, routers, etc.
- Virtually indestructible Lexan is guaranteed for life
- Shroud does not obscure visibility
- Shroud swivels freely around mandrel, so the hose can be repositioned with ease
- Works with the grinders you already own - NO MODIFICATIONS REQUIRED
- Built-in Positive Lock swivel hose fitting – hoses won't pull free



Burr Shroud

Item No	NSN	Description	Price
674-A1216BR		Burr Shroud 1in	



Side View



Front View



MANDREL OPTIONS

- Shrouds with a 674- prefix have a 1/4in mandrel
- For Metric Size Mandrels Replace 674- with 774- and append suffix below

MODEL SUFFIX	MANDREL SIZE	COLLET SIZE
-60L	6MM LONG	6MM

Rotary Shrouds for Hook & Loop Abrasives

Tight Access shroud includes: disc holder, mandrel, 2' x 3/4" hose whip and swivel adapter for connection to 1" vacuum hoses.

Clear Revolution shroud includes: disc holder, mandrel, 2' x 1" hose whip and swivel adapter for connection to 1" vacuum hoses. Refer to hose and fitting section for other hose adapters.



Fits straight or right angle grinders with collets

Features

- Fits ANY tool with collet sizes listed below – straight or right angle sanders, grinders, routers, etc.
- Lexan Shrouds are virtually indestructible and guaranteed for life
- Lexan Shrouds do not obscure visibility



Tight Access Shroud 1/8in Mandrel
7/8in (22mm) Disc Holder



Clear Revolution Shroud
Notched for Visibility & Access
7/8in (22mm) Disc Holder



Clear Revolution Shroud
7/8in (22mm) Disc Holder



Clear Revolution Shroud
Notched for Visibility & Access
2-1/2in (51mm) Disc Holder



Clear Revolution Shroud
2-1/2in (51mm) Disc Holder



Clear Revolution Shroud
Notched for Visibility & Access
1-1/4in (32mm) Disc Holder



Clear Revolution Shroud
1-1/4in (32mm) Disc Holder

7/8in (22mm) JHook Shrouds

Model	NSN	Description	Price
674-A1114J14		Tight Access Shroud 7/8in JHook 1/8in Mandrel	
674-A1216J14		1in Clear Rev Shroud 7/8in JHook	
674-A1214J14		1in Clear Rev Shroud Notched 7/8in JHook	

Clear Revolution 1-1/4in (32mm) JHook Shrouds

Model	NSN	Grinder	Price
674-A1232J20		2in Clear Rev Shroud 1.25in Jhook	
674-A1230J20		2in Clear Rev Shroud Notched 1.25in JHook	

Clear Revolution 1-5/16 (33mm) JHook Shrouds

Model	NSN	Grinder	Price
674-A1232J21		Jhook Shroud 1-5/16 Pad	
674-A1230J21		Jhook Shroud 1-5/16 Pad notched	

Clear Revolution 2-1/2 (64mm) JHook Shrouds

Model	NSN	Grinder	Price
674-A1248J40		3in Clear Rev Shroud 2.5in JHook	
674-A1246J40		3in Clear Rev Shroud Notched 2.5in JHook	

MANDREL OPTIONS

- Shrouds with a 674- prefix have a 1/4in mandrel
- For Metric Size Mandrels Replace 674- with 774- and append suffix below
- Not applicable to Tight Access Shroud

MODEL SUFFIX	MANDREL SIZE	COLLET SIZE
-48S	4.8MM SHORT	4.8MM
-48L	4.8MM LONG	4.8MM
-49S	4.95MM SHORT	4.95MM
-49L	4.95MM LONG	4.95MM
-60S	6MM SHORT	6MM
-60L	6MM LONG	6MM

Shrouds for Flap Wheels and Buffing Wheels

Shrouds accept either flap wheels or buffing wheels. Notched shrouds expose more of the wheel. Letterbox models are more enclosed and provide greater dust extraction if conditions permit their use.

Every shroud includes: mandrel, 2' x 1" hose whip and swivel adapter for connection to 1" vacuum hoses. Refer to hose and fitting section for other hose adapters.

Features

- Fits ANY tool with collet sizes listed below – straight or right angle sanders, grinders, routers, etc.
- Lexan Shrouds are virtually indestructible and guaranteed for life
- Lexan Shrouds do not obscure visibility
- Abrasive flap wheels not included



1-1/2 x 1in
(38 x 25mm)
Open Bottom



1-1/2 x 1in
(38 x 25mm)
Closed Bottom



1-1/2 x 1in
(38 x 25mm)
Letterbox



2-1/2 x 2in
(64 x 51mm)
Open Bottom



2-1/2 x 1in
(64 x 25mm)
Open Bottom



2-1/2 x 1in
(64 x 25mm)
Closed Bottom



2-1/2 x 1in
(64 x 25mm)
Letterbox



2-1/2 x 2in
(64 x 51mm)
Closed Bottom

Flap Wheel Shroud 1-1/2 x 1in (38 x 25mm)

Model	NSN	Description	Price
674-A2432		Flap Wheel Shroud 1.5 x 1in Notched Open Bottom	
674-A2532		Flap Wheel Shroud 1.5in Notched	
674-A2632		Flap Wheel Shroud 1.5in Letterbox	

Flap Wheel Shroud 2-1/2 x 1in (64 x 25mm)

Model	NSN	Description	Price
674-A2448		Flap Wheel Shroud 2.5 x 1in Notched Open Bottom	
674-A2548		Flap Wheel Shroud 2.5in Notched	
674-A2648		Flap Wheel Shroud 2.5in Letterbox	

Flap Wheel Shroud 2-1/2 x 2in (64 x 51mm)

Model	NSN	Description	Price
674-A2748		Flap Wheel Shroud 2.5 x 2in Notched	
674-A2948		Flap Wheel Shroud 2.5 x 2in Notched Open Bottom	

MANDREL OPTIONS

- Shrouds with a 674- prefix have a 1/4in mandrel
- For Metric Size Mandrels Replace 674- with 774- and append suffix below

MODEL SUFFIX	MANDREL SIZE	COLLET SIZE
-48S	4.8MM SHORT	4.8MM
-48L	4.8MM LONG	4.8MM
-49S	4.95MM SHORT	4.95MM
-49L	4.95MM LONG	4.95MM
-60S	6MM SHORT	6MM
-60L	6MM LONG	6MM

Rivet Shaver Shroud (sold with or without Dotco rivet shaver)

Our Tool Specific Rivet Shaver Shroud complements a 20K RPM 1¼" Dotco Rivet Shaver.

The shroud can be used with or without stabilizer.

Every shroud includes: 2' x ¾" hose whip, and swivel adapter for connection to 1" vacuum hose. Refer to hose and fitting section for other hose adapters.

Features

- Precision finished anodized aluminum housing
- Shroud does not obscure visibility
- Shroud swivels on tool with stabilizer
- Positive Lock hose fitting – hoses won't pull free



1-1/4" Rivet Shaver Shroud

Model	NSN	Cutter Capacity	Rivet Shaver	Orientation	Motor RPM	Motor HP (W)	Air Inlet ID inch (mm)	Weight lbs (kg)	Price
674-A3520		1-1/4"	Not Included	-	-	-	-	-	
690-73000-01		1-1/4"	Dotco 14CNL60-95	Pistol Grip	20,000	1	1/4"	4.5 (2.0)	
690-73000-02		1-1/4"	Dotco 14CFS60-95	Pistol Grip	29,000	0.4	1/4"	-	

⚠ Never exceed the maximum operating speed of your abrasive.

★ Available on GSA Advantage website @ www.GSAadvantage.gov



Please call for other Tool & Shroud combinations that may be available.

ABRASIVES

DustMaster Abrasives • Quick Change Discs & Surface Prep Kits



All About Abrasives

Grit Size refers to the size of the particles of abrading materials embedded in the sandpaper. A number of different standards have been established for grit size. These standards establish not only the average grit size, but also the allowable variation from the average. The two most common are the United States CAMI (Coated Abrasive Manufacturers Institute, now part of the Unified Abrasives Manufacturers' Association) and the European FEPA (Federation of European Producers of Abrasives) "P" grade. The FEPA system is the same as the ISO 6344 standard. Clayton abrasives follow the ISO/FEPA "P" grade system.

Grit Size Table

	ISO/FEPA Grit	CAMI Grit	Average Particle Diameter (µm)
MACROGRITS			
Extra Coarse	P12		1815
	P16		1324
	P20		1000
	P24		764
	P30	24	708
		30	642
		36	530
	P36		538
Coarse	P40	40	425
		50	348
	P50		336
Medium		60	265
	P60		269
	P80		201
		80	190
Fine	P100		162
		100	140
	P120		125
Very Fine		120	115
	P150		100
		150	92
	P180	180	82
	220	68	
MICROGRITS			
Very Fine	P240		58.5
		240	53
	P280		52.2
	P320		46.2
	P360		40.5
Extra fine		320	36
	P400		35
	P500		30.2
		360	28
	P600		25.8
Super fine		400	23
	P800		21.8
		500	20
	P1000		18.3
		600	16
Ultra fine	P1200		15.3
	P1500	800	12.6
	P2000	1000	10.3
	P2500		8.4

Abrasive Materials

Aluminum Oxide exhibits a high degree of friability. This means that when heat and pressure are applied it fragments. This is highly desirable because when the abrasive fragments it creates new sharp edges. This self-renewing property allows Aluminum Oxide to last longer.

Silicon Carbide is harder than Aluminum Oxide. This makes it suitable for cutting harder materials such as metal, paint, plastic, and fiberglass. Silicon carbide is also a friable abrasive and creates new sharp edges as it fractures.

Stearated Abrasives have a dry lubricant loaded to the abrasive. Stearated abrasives are useful in sanding coats of finish and paint since the stearate "soap" prevents clogging and increases the useful life of the sandpaper. Aluminum Oxide with stearate is also known as PS33. While difference chemical stearates are available such as zinc, calcium, and magnesium, zinc stearate is the most common.

Abrasive Attachment Methods

There are two components involved in abrasive attachment, the abrasive pad itself and the sander backup pad to which it is attached.

J-Hook uses tiny hooks and loops to hold the abrasive pad securely to the sander. The J-Hooks are longer than the hooks in the Hook & Loop attachment method and create a small space between the abrasive and sander. This channel provides more air flow and better transport for the dust across and thru the disc.



Requires J-Hook backup pad and Hook & Loop abrasive. J-Hook is the attachment method of choice for Clayton sanders and abrasives.

Hook & Loop also uses tiny hooks and loops to hold the abrasive pad securely to the sander. The hooks are shorter than the hooks in the J-Hook attachment method and do not create a space between the abrasive and sander. Requires Hook & Loop backup pad and Hook & Loop abrasive

PSA (pressure sensitive adhesive) uses an adhesive to adhere the abrasive to the sander backup pad. The adhesive on PSA abrasives dries out over time and therefore has a limited shelf life. PSA backup pads typically have a smooth vinyl surface and a small number of large holes for dust collection.

DustMaster Supreme Screen Abrasive

(Aluminum Oxide, Zinc Stearated, Hook & Loop)



- Revolutionary abrasive specifically designed for dustless sanding
- Screen-like composition dramatically improves dust extraction
- Won't clog and pill like conventional abrasives
- Lasts 3-7 times longer than 5 or 6 hole paper abrasives
- A 6" disc contains approximately 24,000 holes

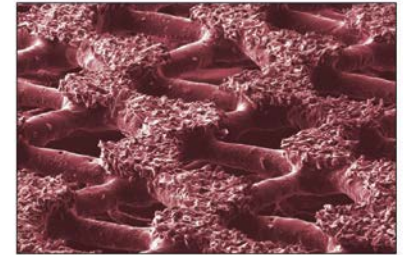

DustMaster Supreme Screen Abrasive

Model	NSN	Size	Grit	Pieces	Price
830-DMS080HV	▲	3"	80	250	
830-DMS100HV			100	250	
830-DMS120HV	▲		120	250	
830-DMS150HV			150	250	
830-DMS180HV	▲		180	250	
830-DMS220HV			220	250	
830-DMS240HV	▲		240	250	
830-DMS320HV	▲		320	250	
830-DMS400HV			400	250	
850-DMS080HV		5"	80	250	
850-DMS100HV			100	250	
850-DMS120HV			120	250	
850-DMS150HV			150	250	
850-DMS180HV			180	250	
850-DMS220HV			220	250	
850-DMS240HV			240	250	
850-DMS320HV			320	250	
850-DMS400HV			400	250	
850-P080-100	▲	5"	80	100	
850-P120-100	▲		120	100	
850-P180-100	▲		180	100	
850-P240-100	▲		240	100	
850-P320-100	▲		320	100	
860-DMS080HV	▲	6"	80	250	
860-DMS100HV			100	250	
860-DMS120HV	▲		120	250	
860-DMS150HV			150	250	
860-DMS180HV	▲		180	250	
860-DMS220HV			220	250	
860-DMS240HV	▲		240	250	
860-DMS320HV	▲		320	250	
860-DMS400HV			400	250	
880-P80HV		8"	80	50	
880-P120HV			120	50	
880-P180HV			180	50	
880-P240HV			240	50	
880-P320HV			320	50	



DustMaster Supreme Screen Abrasive

Model	NSN	Size	Grit	Pieces	Price
834-DMS080HV		3x4	80	250	
834-DMS120HV	▲		120	250	
834-DMS180HV	▲		180	250	
834-DMS240HV	▲		240	250	
834-DMS320HV	▲		320	250	
837-DMS080HV		3 2/3 x 7	80	250	
837-DMS120HV	▲		120	250	
837-DMS180HV	▲		180	250	
837-DMS240HV	▲		240	250	
837-DMS320HV	▲		320	250	
805-DMS080HV		2 3/4 x 5	80	250	
805-DMS120HV			120	250	
805-DMS180HV			180	250	
805-DMS240HV			240	250	
805-DMS320HV			320	250	
805-DMS400HV			400	250	
808-DMS080HV		2 3/4 x 8	80	250	
808-DMS120HV			120	250	
808-DMS180HV			180	250	
808-DMS240HV			240	250	
808-DMS320HV			320	250	
808-DMS400HV			400	250	
816-DMS080HV		2 3/4 x 16	80	250	
816-DMS120HV			120	250	
816-DMS180HV			180	250	
816-DMS240HV			240	250	
816-DMS320HV			320	250	
816-DMS400HV			400	250	

* Available on GSA Advantage website @ www.GSAadvantage.gov



Call 732-363-2100 / 800 248-8650 or Order 24 hours a day from our website @ www.JClayton.com



DustMaster Coarse

(Special Ceramic and Aluminum Oxide Blend, Zinc Stearated, Hook & Loop)

DustMaster Coarse uses a nylon mesh backing material to create a more flexible, durable, and consistent abrasive surface. Ceramic grains allow for maximum cutting speed and consistent performance across a variety of surfaces and substrates. Excellent resistance to edge wear and clogging.

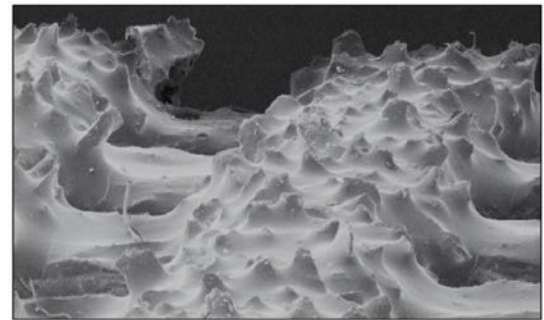
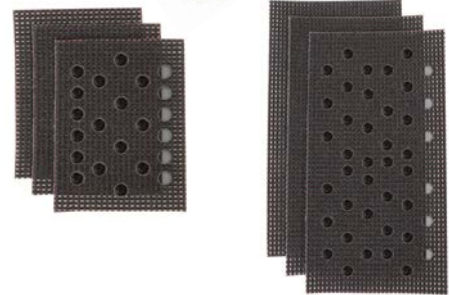

DustMaster Supreme Coarse

Model	NSN	Size	Grit	Pieces	Price
850-DMC040HV		5"	40	50	
850-DMC060HV			60	50	
850-DMC080HV			80	50	
850-DMC120HV			120	50	
860-DMC040HV		6"	40	50	
860-DMC060HV			60	50	
860-DMC080HV			80	50	
860-DMC120HV			120	50	
834-DMC040HV		3 x 4"	40	50	
834-DMC060HV			60	50	
834-DMC080HV			80	50	
834-DMC120HV			120	50	
837-DMC040HV		3-2/3 x 7"	40	50	
837-DMC060HV			60	50	
837-DMC080HV			80	50	
837-DMC120HV			120	50	

DustMaster Silicon Carbide Abrasive

(Silicon Carbide, Non-Stearated, Hook & Loop)

This abrasive's patented texture build-up and multi-hole design allows continuous dust extraction over the entire surface and thus a nearly dust free sanding process. The increased air flow reduces heat and clogging during the entire sanding process. A 6" disc contains approximately 225 holes.



SiC

Model	NSN	Size	Grit	Pieces	Price
834-SC080HV		3 x 4"	80	50	
834-SC120HV			120	50	
834-SC180HV			180	50	
834-SC240HV			240	50	
834-SC320HV			320	50	
837-SC080HV			3 2/3 x 7"	80	50
837-SC120HV		120		50	
837-SC180HV		180		50	
837-SC240HV		240		50	
837-SC320HV		320		50	

SiC

Model	NSN	Size	Grit	Pieces	Price
830-SC080HV		3"	80	50	
830-SC120HV			120	50	
830-SC180HV			180	50	
830-SC240HV			240	50	
830-SC320HV			320	50	
850-SC080HV			5"	80	50
850-SC120HV		120		50	
850-SC180HV		180		50	
850-SC240HV		240		50	
850-SC320HV		320		50	
860-SC080HV		6"		80	50
860-SC120HV			120	50	
860-SC180HV			180	50	
860-SC240HV			240	50	
860-SC320HV			320	50	

* Available on GSA Advantage website @ www.GSAadvantage.gov



DustMaster Gold Abrasive

(Aluminum Oxide, Stearated, PSA)

- A durable product very well suited for sanding at high speeds, Gold is designed for both finishing and heavy stock removal.
- The durable aluminum oxide grain delivers a fast, exceptionally long lasting cut.
- Proprietary backing is stronger than other brands using traditional backing.
- High strength resin bonding for superior grain support.
- A special stearate coating resists clogging and loading.
- A uniform, semi open coat design produces an even, consistent scratch pattern.
- 5, 6 or 8 hole discs depending on size
- Pull tabs make it easy to remove backing

Gold Abrasive

Model	NSN	Size	Grit	Pieces	Price
830-G080SV		3"	80	100	
830-G100SV			100	100	
830-G120SV			120	100	
830-G150SV			150	100	
830-G180SV			180	100	
830-G220SV			220	100	
830-G240SV			240	100	
830-G280SV			280	100	
830-G320SV			320	100	
830-G360SV			360	100	
835-G080S	▲	3.5"	80	100	
835-G100S	▲		100	100	
835-G120S	▲		120	100	
835-G150S	▲		150	100	
835-G180S	▲		180	100	
835-G220S	▲		220	100	
835-G240S	▲		240	100	
835-G320S	▲		320	100	
835-G400S	▲		400	100	
850-G080SV	▲		5"	80	100
850-G100SV	▲	100		100	
850-G120SV	▲	120		100	
850-G150SV	▲	150		100	
850-G180SV	▲	180		100	
850-G220SV	▲	220		100	
850-G240SV	▲	240		100	
850-G280SV	▲	280		100	
850-G320SV	▲	320		100	
850-G400SV	▲	400		100	
850-G500SV	▲	500	100		
860-G080SV	▲	6"	80	100	
860-G100SV	▲		100	100	
860-G120SV	▲		120	100	
860-G150SV	▲		150	100	
860-G180SV	▲		180	100	
860-G220SV	▲		220	100	
860-G240SV	▲		240	100	
860-G280SV	▲		280	100	
860-G320SV	▲		320	100	
860-G400SV	▲		400	100	
860-G500SV	▲	500	100		



★ Available on GSA Advantage website @ www.GSAadvantage.gov

Understanding Quick Change Disc Abrasives and Backup Pads

Clayton quick change disc abrasives and backup pads support both TR, TS, and TP attachment methods.

TR

Threaded stud is on the abrasive
Threaded socket is in the backup pad

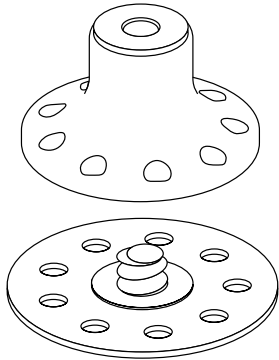

TS

Threaded socket is on the abrasive
Threaded stud is in the backup pad

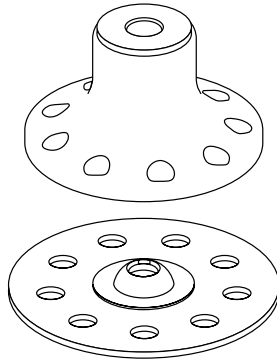

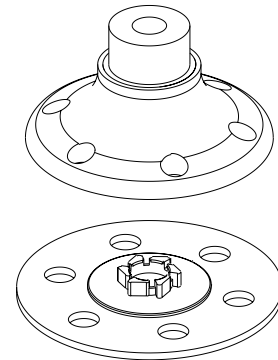

TP

Threaded socket is on the abrasive
Threaded stud is in the backup pad





1" Quick Change

Abrasive Attachment	Abrasive Holes	Pad Holes	NSN	Pad Item No	Price
 TR	0	0		672-1016TR	
 TS	0	0		672-1016TS	

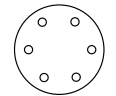
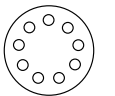
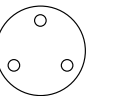

1" quick change disc abrasives and backup pads are not ventilated due to size restrictions.

2" Quick Change

Abrasive Attachment	Abrasive Holes	Pad Holes	Resulting Holes	Incidence	NSN	Pad Item No	Price
 TR				60° / 6x		672-1032TR-09	
 TS						672-1032TS-09	

2" quick change disc abrasives have 6 holes and should be used with 9 hole backup pads

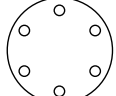
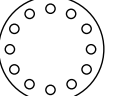
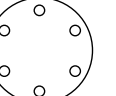
3" Quick Change

Abrasive Attachment	Abrasive Holes	Pad Holes	Resulting Holes	Incidence	NSN	Pad Item No	Price
 TR				30° / 12x		672-1048TR-12	
 TS						672-1048TS-12	

3" quick change disc abrasives have 6 holes and should be used with 12 hole backup pads

* Available on GSA Advantage website @ www.GSAadvantage.gov

Quick Change Resin Bond Discs

- Resin Bond Aluminum Oxide
- Convenient sizes for difficult to reach sanding operations
- Tough poly-cotton and polyester backings with resin bonding

Quick Change Disc - Resin Bond - TR

Model	NSN	Size	Mount	Hole Pattern	Grit	Pieces	Price
800-16M036	▲	1"		None	36	250	
800-16M060	▲				60	250	
800-16M080	▲				80	250	
800-16M120	▲				120	250	
800-16M150					150	250	
800-16M180					180	250	
800-16M240					240	250	
800-16M320					320	250	
800-32M036V	▲				2"		
800-32M060V	▲	60	250				
800-32M080V	▲	80	250				
800-32M120V	▲	120	250				
800-32M150V		150	250				
800-32M180V		180	250				
800-32M240V		240	250				
800-32M320V		320	250				
800-48M036V	▲	3"					
800-48M060V	▲				60	250	
800-48M080V	▲				80	250	
800-48M120V	▲				120	250	
800-48M150V					150	250	
800-48M180V					180	250	
800-48M240V					240	250	
800-48M320V					320	250	



Available in TR TS/TSM and TP

Quick Change Disc - Resin Bond - TS

Model	NSN	Size	Mount	Pattern	Grit	Pieces	Price
800-16F036	▲	1"		None	36	250	
800-16F060	▲				60	250	
800-16F080	▲				80	250	
800-16F120	▲				120	250	
800-16F150					150	250	
800-16F180					180	250	
800-16F240					240	250	
800-16F320					320	250	
800-32F036V	▲				2"		
800-32F060V	▲	60	250				
800-32F080V	▲	80	250				
800-32F120V	▲	120	250				
800-32F150V		150	250				
800-32F180V		180	250				
800-32F240V		240	250				
800-32F320V		320	250				
800-48F036V	▲	3"					
800-48F060V	▲				60	250	
800-48F080V	▲				80	250	
800-48F120V	▲				120	250	
800-48F150V					150	250	
800-48F180V					180	250	
800-48F240V					240	250	
800-48F320V					320	250	







Quick Change Disc - Resin Bond - TP

Model	NSN	Size	Mount	Pattern	Grit	Pieces	Price
800-16TP036	▲	1"		None	36	100	
800-16TP060	▲				60	100	
800-16TP080	▲				80	100	
800-16TP120	▲				120	100	
800-16TP150					150	100	
800-16TP180					180	100	
800-16TP240					240	100	
800-16TP320					320	100	
800-32TP036V	▲				2"		
800-32TP060V	▲	60	100				
800-32TP080V	▲	80	100				
800-32TP120V	▲	120	100				
800-32TP150V		150	100				
800-32TP180V		180	100				
800-32TP240V		240	100				
800-32TP320V		320	100				
800-48TP036V	▲	3"					
800-48TP060V	▲				60	100	
800-48TP080V	▲				80	100	
800-48TP120V	▲				120	100	
800-48TP150V					150	100	
800-48TP180V					180	100	
800-48TP240V					240	100	
800-48TP320V					320	100	



Quick Change Non Woven Discs

- Superior non-woven product for longer lasting disc life
- Consistent distribution of grit throughout the material
- A fresh cutting surface is exposed as the fiber wears
- Grades Blue/Fine, Red/Medium, and Brown/Coarse

Quick Change Disc - Non Woven - Ventilated with Holes

Model	NSN	Size	Pattern	Grit	Pieces	Price
800-16M003		1"		None	Crs	250
800-16M006	Med				250	
800-16M009	Fin				250	
800-16F003		1"		None	Crs	250
800-16F006	Med				250	
800-16F009	Fin				250	
800-32M003V	▲	2"		None	Crs	250
800-32M006V	▲				Med	250
800-32M009V	▲				Fin	250
800-32F003V		2"		None	Crs	250
800-32F006V					Med	250
800-32F009V					Fin	250
800-48M003V		3"		None	Crs	250
800-48M006V					Med	250
800-48M009V					Fin	250
800-48F003V		3"		None	Crs	250
800-48F006V					Med	250
800-48F009V					Fin	250



Available in TR  and TS/TSM  depending on size.

Quick Change Surface Prep Kits

Surface Prep Grinder Kits

Available in 1", 2" or 3" versions, each kit includes one Dotco right angle grinder, 1 Clear Revolution Shroud, 2 feet of 1" vacuum hose, swivel fittings to connect to your vacuum system, and an assortment of abrasives listed below. All this convenient packed in a deep bin professional organizer.

Surface Prep Grinder Kits

Model	NSN	Attachment	Abrasive Size	Price
690-51612KIT-TR		1in	TR	
690-51612KIT-TS		1in	TS	
690-53212KIT-TR	4130-01-458-8661	2in	TR	
690-53212KIT-TS		2in	TS	
690-53212KIT-TP		2in	TP	
690-54812KIT-TR	4130-01-458-8663	3in	TR	
690-54812KIT-TS		3in	TS	
690-54812KIT-TP		3in	TP	

Deep repositionable bins hold all your abrasives, grinder, shroud, and hose. Case measures 19" x 15" x 4 1/2"



Surface Prep Shroud Kits

If you already have a grinder, then try our Surface Prep Shroud Kits. They include everything our Grinder Kits include except the grinder.

Surface Prep Shroud Kits TR Style

Model	NSN	Attachment	Abrasive Size	Price
690-41612KIT-TR		1in	TR	
690-41612KIT-TS		1in	TS	
690-43212KIT-TR	4130-01-458-8326	2in	TR	
690-43212KIT-TS		2in	TS	
690-43212KIT-TP	4130-01-458-8324	2in	TP	
690-44812KIT-TR	4130-01-459-1793	3in	TR	
690-44812KIT-TS		3in	TS	
690-44812KIT-TP	4130-01-458-8329	3in	TP	



Abrasives Included

Qty	Grit	Type
10	24	Quick Change - Resin Bond
10	36	Quick Change - Resin Bond
10	60	Quick Change - Resin Bond
10	80	Quick Change - Resin Bond
10	120	Quick Change - Resin Bond
10	180	Quick Change - Resin Bond
10	240	Quick Change - Resin Bond
10	320	Quick Change - Resin Bond
10	Coarse	Quick Change - Non Woven
10	Medium	Quick Change - Non Woven
10	Fine	Quick Change - Non Woven



Includes one Clayton Universal Shroud. Choose 1", 2", or 3" shown above.

Includes 12,000 RPM right angle grinder.

Quick Change Assortment Packs

Get the same assortment of discs sold in our grinder kits is either the TR or TS attachment method.

Quick Change TR Disc Sample Packs

Model	NSN	Description	Price
800-16TR000V		1" TR Sample Pack	
800-32TR000V		2" TR Sample Pack	
800-48TR000V		3" TR Sample Pack	

Quick Change TS Disc Sample Packs

Model	NSN	Description	Price
800-16TS000V		1" TS Sample Pack	
800-32TS000V		2" TS Sample Pack	
800-48TS000V		3" TS Sample Pack	

* Available on GSA Advantage website @ www.GSAadvantage.gov

Abrasives Included

Qty	Grit	Type
10	24	Quick Change - Resin Bond
10	36	Quick Change - Resin Bond
10	60	Quick Change - Resin Bond
10	80	Quick Change - Resin Bond
10	120	Quick Change - Resin Bond
10	180	Quick Change - Resin Bond
10	240	Quick Change - Resin Bond
10	320	Quick Change - Resin Bond
10	Coarse	Quick Change - Non Woven
10	Medium	Quick Change - Non Woven
10	Fine	Quick Change - Non Woven



3M Scotch-Brite Bristle Discs

Long life with consistent performance - Scotch-Brite Bristle Discs & Brushes last longer than most abrasives and provide the same finish and cut throughout their life. For productivity in automated procedures, there are fewer changeovers.

Conformability - Unlike most abrasives, Scotch-Brite Bristle products are flexible and conform to irregular surfaces. You can expect a consistent finish even on the most complex parts.

Safety - To help you meet increasingly tough safety standards, Scotch-Brite bristle discs contain no wire filaments. When replacing chemicals or compounds, they have the added benefit of not emitting harmful chemical vapors.
Stackable – Bristle Discs are approximately 0.157" thick and can be stacked to increase the width of abrasive surface.

3M Radial Bristle Discs T-A

The high concentration of Aluminum Oxide and Cubitron Abrasive Grain in T-A (Type Angled) Bristle Discs combined with their small 3" size aggressively cleans and deburrs, in tighter areas and can be used on most die grinders.

- Recommended tool speed: 12,000 RPM
- Requires 3/8" mandrel

3M Radial Bristle Discs T-A

Model	NSN	Size	Grade	Color	Max Speed	Pieces	Price
678-24279		3"	50	Green	25,000	10	
678-24280		3"	80	Yellow	25,000	10	
678-24281		3"	120	White	25,000	10	



Scotch-Brite Radial Bristle Disc 360 & SPA

Radial Bristle Discs are much less likely to damage or gouge the work surface than traditional abrasive. Scotch-Brite 360 Grit (Aluminum Oxide) and SPA (Special Plastic Abrasive) are so easy to control; the operator can remove paint one layer at a time. Other benefits include a lower surface temperature than competitive products, and a minimized work area. The flexible bristles conform to the part allowing for a uniform finish.

- Recommended tool speed: 12,000 RPM
- Requires 3/8" mandrel
- Endorsed by NAVAIR 

3M Radial Bristle Discs 360 & SPA

Model	NSN	Size	Grade	Color	Max Speed	Pieces	Price
678-33227		3"	360	Lime	25,000	10	



Scotch-Brite SR Radial Bristle Discs

Fast sealant removal without affecting underlying paint. These plastic abrasive particle-filled products remove 1/16 inch or less of sealants, silicones, RTVs, and adhesives from most surfaces. The unique construction removes the sealant but not the underlying paint or other coating. That means less time for rework.

- Recommended tool speed: 12,000 RPM.
- Requires 3/8" mandrel

3M Radial Bristle Discs SR

Model	NSN	Size	Grade	Color	Max Speed	Pieces	Price
678-30098		3"	-	Cream	20,000	10	



* Available on GSA Advantage website @ www.GSAadvantage.gov

Cut Off Wheels - Resin Bonded Aluminum Oxide

- Type 1 / Type 41 fiberglass reinforced resin bonded
- General purpose cutting on aluminum, iron, steel, carbon steel and stainless steel
- Recommended for use with Clayton Cutoff Saws & Radial Shrouds



Cutoff Saw
1/4" Arbor

Radial Shroud
3/8" Arbor

Resin Cut Off Wheels

Model	NSN	Material	RPM	Diameter	Kerf	Arbor	Pieces	Price
250-CW32R04-10		Aluminum Oxide	30K	2"	1/16"	1/4"	10	
250-CW48R04-10		Aluminum Oxide	25K	3"	1/16"	1/4"	10	
250-CW48R06-10		Aluminum Oxide	25K	3"	1/16"	3/8"	10	
250-CW64R06-10		Aluminum Oxide	19K	4"	1/16"	3/8"	10	

Cut Off Wheels - Steel Diamond Coat

- Hardened steel alloy disc
- Diamond coat metal bond 40 grit
- Continuous rim
- Recommended for use with Clayton Cutoff Saws & Radial Shrouds



Cutoff Saw
1/4" Arbor

Radial Shroud
3/8" Arbor

Diamond Cut Off Wheels

Model	NSN	Material	RPM	Diameter	Kerf	Arbor	Pieces	Price
250-CW32D04	4130-01-517-1038	Diamond	30K	2"	0.08	1/4"	1	
250-CW48D04		Diamond	30K	3"	0.08	1/4"	1	
250-CW48D06		Diamond	30K	3"	0.08	3/8"	1	
250-CW64D06	4130-01-501-8633	Diamond	30K	4"	0.08	3/8"	1	

Cut Off Wheels - Zirconia

- Zirconia grain provides a fast cut with an extremely long life
- Ideal for hard to grind materials such as stainless steel and high tensile alloys
- Recommended for use with Clayton Radial Shrouds



Cutoff Saw
1/4" Arbor

Radial Shroud
3/8" Arbor

Zirconia Cut Off Wheels

Model	NSN	Material	RPM	Diameter	Kerf	Arbor	Pieces	Price
250-CW48Z06-10		Zirconia	25K	3"	1/16"	3/8"	10	

* Available on GSA Advantage website @ www.GSAadvantage.gov

HOSES & FITTINGS

Combination Hoses • Hose Adapters & Fittings • Compressed Air Lines • Tool Kits • Support Belts
Distribution Module & Rover



Clayton Stock & Custom Compressed Air & Vacuum Hoses

Available in a variety of lengths and configurations, all Clayton dustless sanding hoses incorporate features specifically designed for dustless sanding. Combination hoses supply compressed air to tools, and allow unrestricted flow of dust & debris back to the vacuum.

Eliminate Static

- Carbon Black conductive vacuum hoses and cuffs eliminate static buildup
- Resistivity <math>< 10^6</math> ohms/sq

High Flow Couplers

- Large-bore high flow air fittings provide maximum cfm to tools

Sheathing

- Durable Sheathing slides easily over edges and rough surfaces without snagging and catching
- No exposed fasteners to catch or damage surfaces
- Sheathing extends hose life
- Crush-proof construction ensures long life



Custom hoses and assemblies are available upon request. Sizes include ¾", 1", 1½", and 2" with a variety of cuff and connector options.

NOTE: ALL hoses in your system must be static dissipating, and must be properly bonded and grounded during operation

Work Hoses - Combination Air / Vacuum

Primarily used between a vacuum and tool such as a Clayton sander with 1" exhaust, the work hose supplies compressed air to tools and carries debris away in a single hose assembly.

- 1½" diameter vacuum hose provides virtually unrestricted air flow
- Hose reduces to 1" five feet before sander for maximum flexibility
- 1½" metal sleeve connects to vacuum system, bare 1" hose connects to tool
- Carbon Black conductive hose and cuffs eliminate static buildup
- Resistivity < 10⁶ ohms/sq
- ¾" compressed air line and ¼" high flow plug & coupler supply air to tool

1-1/2" Combination Air / Vac Work Hoses

Model	NSN	Vac Hose	Air Line	Length	Price
671-AVHW2416-10	4720-01-652-0544	1-1/2"	3/8"	10'	
671-AVHW2416-20	4130-01-460-1438	1-1/2"	3/8"	20'	
671-AVHW2416-30	4130-01-460-6091	1-1/2"	3/8"	30'	
671-AVHW2416-40	4720-01-519-7365	1-1/2"	3/8"	40'	
671-AVHW2416-50	4130-01-460-1442	1-1/2"	3/8"	50'	
671-AVHW2416-75		1-1/2"	3/8"	75'	

① For tools with a ¾" swivel request our ¾" hose adapter



Extension Hoses - Combination Air / Vacuum

Work hose isn't long enough? Increase your reach with an extension hose. Made to fit between your vacuum and a work hose.

- 1½" diameter vacuum hose provides virtually unrestricted air flow
- 1½" metal sleeve connects to vacuum, 1½" cuff connects to work hose
- Carbon Black conductive hose and cuffs eliminate static buildup
- Resistivity < 10⁶ ohms/sq
- ½" compressed air line and ¼" high flow plug & coupler supply air to tool

1-1/2" Combination Air / Vac Extension Hoses

Model	NSN	Vac Hose	Air Line	Length	Price
671-AVHX24-10		1-1/2"	1/2"	10'	
671-AVHX24-15		1-1/2"	1/2"	15'	
671-AVHX24-20		1-1/2"	1/2"	20'	
671-AVHX24-30		1-1/2"	1/2"	30'	
671-AVHX24-40		1-1/2"	1/2"	40'	
671-AVHX24-50		1-1/2"	1/2"	50'	



Cleanup Hoses - Vacuum Only

Don't need a compressed air line?

- 1½" diameter vacuum hose provides virtually unrestricted air flow
- 1½" metal sleeve connects to vacuum system
- 1½" female cuff receives cleanup wand and tools
- Carbon Black conductive hose and cuffs eliminate static buildup
- Resistivity < 10⁶ ohms/sq

1-1/2" Cleanup Vac Hoses

Model	NSN	Vac Hose	Air Line	Length	Price
671-VHX24-10	4130-01-460-6094	1 1/2"	N/A	10'	
671-VHX24-15		1 1/2"	N/A	15'	
671-VHX24-20	4130-01-460-1448	1 1/2"	N/A	20'	
671-VHX24-30	4130-01-460-6558	1 1/2"	N/A	30'	
671-VHX24-40	4130-01-460-6568	1 1/2"	N/A	40'	
671-VHX24-50	4130-01-460-6577	1 1/2"	N/A	50'	



* Available on GSA Advantage website @ www.GSAadvantage.gov

Vacuum Hose by the Foot

Get high quality Clayton vacuum hose, a la carte. Measured by inside diameter, this plastic hose is crush proof, static conductive, and designed for vacuum applications. All hose features a spiral helix with a reverse thread that matches up to our hose cuffs and threaded fittings.

Vacuum Hose by the Foot

Model	NSN	ID	Price
921-0750PBKSC		3/4"	
921-1000PBKSC		1"	
921-1500PBKSC		1-1/2"	
921-2000PBKSC		2"	

FHT - Female Hose Thread



★ Available on GSA Advantage website @ www.GSAadvantage.gov



Call 732-363-2100 / 800 248-8650 or Order 24 hours a day from our website @ www.JClayton.com



Adapter Hoses

Convert between hose sizes with our standard Adapter Hoses. Available in various lengths with swivel or non-swivel cuffs.

Adapter Hoses

Model	NSN	Desc	Price
671-VHA08-001		Adapter Hose 1" FHT to 1/2" Hose	
671-VHA12-001		Adapt Hose 2' - 3/4" Hose to 1" FHT	
671-VHA12-002		Adapt Hose 2' - 3/4" Hose to 3/4" FHT Swivel	
671-VHA12-003		Adapt Hose 2' - 3/4" Hose to 1" FHT Swivel	
671-VHA16-001		Adapt Hose 2' - 1" Hose to 3/4" FHT	
671-VHA16-002		Adapt Hose 2' - 1" Hose to 1.5" FHT	
671-VHA16-003		Adapt Hose 2' - 1" Hose to 1.5" Smooth Cuff	
671-VHA16-004		Adapt Hose 5' - 1" Hose to 1.5" Smooth Cuff	
671-VHA16-005		Adapt Hose 5' - 1" Hose to 1.5" Sleeve	
671-VHA16-006		Adapt Hose 2' - 1" Hose to 1" FHT Swivel	
671-VHA16-007		Adapt Hose 5' - 1" Hose to 1.5" FHT	
671-VHA16-008		Adapt Hose 14' - 1" Hose to 1.5" Smooth Cuff w/ Cap	
671-VHA16-009		Adapt Hose 2' - 1" Hose to 1.25 Smooth Cuff	
671-VHA16-010		Adapt Hose 25' - 1" Hose to 1.5" Smooth Cuff w/ Cap	
671-VHA16-011		Adapt Hose 5' - 1" Hose to 1.25 Hose FHT	
671-VHA16-012		Adapt Hose 12' - 1" Hose to 1.5" Sleeve w/Cap	
671-VHA16-013		Adapter Hose 1" x 72"	
671-VHA16-014		Adapter Hose, 1 x 144", 1 x 1 Swivel Coupler	
671-VHA16-015		Adapt Hose 5' - 1" Hose to 1.25 Smooth Cuff	
671-VHA16-016	4130-01-460-1339	Adapter Hose 5' - 1" Cuff to 1.25" Cuff	
671-VHA16-017	4130-01-460-6084	Adapter Hose 10' - 1" Cuff to 1.25" Cuff	



FHT - Female Hose Thread

Adapter Hoses

Model	NSN	Desc	Price
671-VHA16-018		Adapt Hose 30" - 1" Hose to 1.5" FHT Yellow w/ Adhesive	
671-VHA16-019		Adapter Hose 5' - 1.25" Cuff to 1.25" Cuff	
671-VHA16-020		Adapter Hose 1" x 1-1/4" X 20'	
671-VHA16-021		Adapter Hose 1' - 1" Hose Qd 1" FHT	
671-VHA16-022		Adapter Hose 4' - 1" Hose to 1-1/4" Smooth Cuff	
671-VHA16-023		Adapt Hose 10' - 1.25 Cuff to 1.5 Cuff	
671-VHA24-001		Adapt Hose 2' - 1.5" Sleeve to 1.5" Smooth Swivel	
671-VHA24-002		Adapt Hose 2' - 1.5" Sleeve to 1.25" Smooth	
671-VHA24-003		Safe Filter Change Hose 3'	
671-VHA24-004		Adapter Hose 30' - 1.5 to 1.5 Cuff	
671-VHA24-005		Barracuda Drain Hose	
671-VHA16-012		Adapt Hose 12' - 1" Hose to 1.5" Sleeve w/Cap	
671-VHA16-013		Adapter Hose 1" x 72"	
671-VHA32-001		Hose for CV-YUL01-01	
671-VHA32-10		2" Connection Hose, 10'	



FHT - Female Hose Thread

★ Available on GSA Advantage website @ www.GSAadvantage.gov

Hose Cap Assemblies

Use these replacement cuff sleeve and cap assemblies at the end of your 1", 1-1/2", and 2" hoses. All cuffs are conductive.

Hose Cap Assemblies

Model	NSN	Description	Price
921-HS1624		Cuff-Sleeve assembly 1" FHT to 1.5" Galv Sleeve	
921-HS1624-C		Cuff-Sleeve-Cap assembly 1" FHT to 1.5" Galv Sleeve	
921-HS2424		Cuff-Sleeve assembly 1.5" FHT to 1.5" Galv Sleeve	
921-HS2424-C		Cuff-Sleeve-Cap assembly 1.5" FHT to 1.5" Galv Sleeve	
921-HS2432		Cuff-Sleeve assembly 1.5" FHT to 2" Galv Sleeve	
921-HS3224		Cuff-Sleeve assembly 2" FHT to 1.5" Galv Sleeve	
921-HS3224-C		Cuff-Sleeve-Cap assembly 2" FHT to 1.5" Galv Sleeve	
921-HS3232		Cuff-Sleeve assembly 2" FHT to 2" Galv Sleeve	
671-20CAP		Rubber Hose Cap for 1" Hose	
671-24CAP		Rubber Hose Cap for 1.5" Sleeve	



FHT - Female Hose Thread

Hose Holders

Keep your hoses off the floor and organized with our large stainless steel wall mount hose holders.

Hose Holders

Model	NSN	Description	Price
650-008		Hose Holder Medium	
650-012		Hose Holder Large	

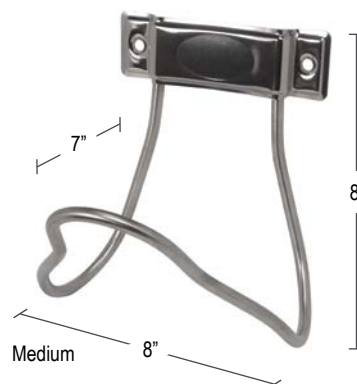

* Available on GSA Advantage website @ www.GSAadvantage.gov

Torque Reducing Right Angle Sander Extension

Decrease torque and reduce hand fatigue with our 1' combination Air/Vac hose whip.

Torque or Moment is the tendency of a force to rotate an object around an axis or center. In this case the center of the sander. Torque = force x distance (from the axis of rotation)

For this example we'll use 5' of hose weighing 2 lbs

Standard Hose Connection: $T = 2 \text{ lbs} \times 11\text{in} = 22 \text{ in-lbs of Torque}$
 With Right Angle Extension: $T = 2 \text{ lbs} \times 7\text{in} = 14 \text{ in-lbs of Torque}$

By using the Right Angle Extension we have reduced the torque by 36%

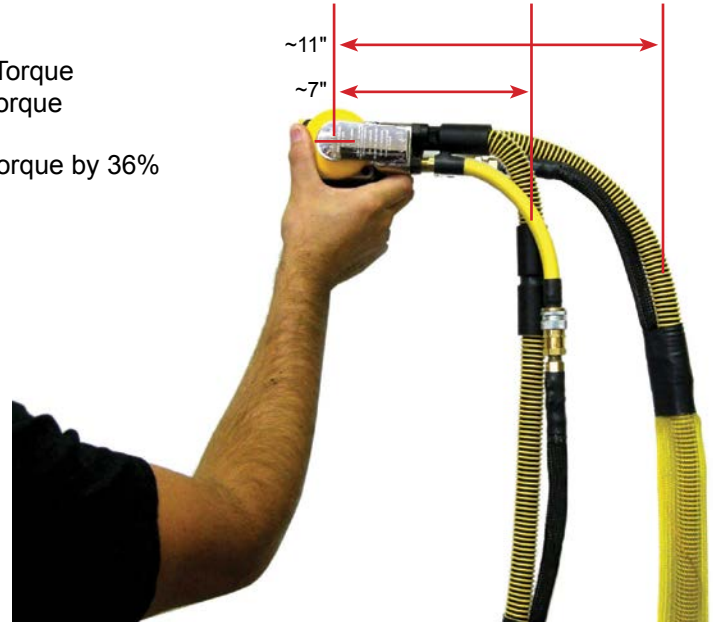

Right Angle Extension

Model	NSN	Length	Hose	Price
671-AVHA1212-01		1'	3/4"	
671-AVHA1616-01		1'	1"	



Sleeves & Y's

Sleeves and Ys are tapered to fit into our standard vacuum inlet.

Sleeves & Ys

Model	NSN	Description	Price
631-001	4730-01-520-7058	Hose Sleeve 1.5in Stainless Steel	
631-003		Hose Sleeve 1.5in Galvanized	
631-002		Hose Adapter, 2in, Tapered Fit	
661-H32T	4730-01-519-7010	Hose Connector, 2 X 1.5in, Steel	
921-HQ2424	4130-01-460-2498	1-1/2in Quick-Lok Swivel Connector Cuff Assy	
671-150Y	4730-01-519-5907	Y Adapter 1.5in Expanded Ends Galv	
671-151Y		Y Adapter 1.5in Expanded Ends SS	
921G-24Y		Y Adapter 1.5in Straight Ends Galv	
631-006		Y Adapter 1.5in Straight Ends SS	



2" Galvanized



1-1/2" Stainless



1-1/2" Galvanized



1-1/2" to 2" Chrome



1-1/2" to Swivel Lock



* Available on GSA Advantage website @ www.GSAadvantage.gov

Hose Cuffs

Static conductive hose cuffs are impregnated with carbon black to make them conductive. They are usually used to connect a hose to a tool or vacuum. These cuffs have a female thread to accept vacuum hose on one side and a smooth bore to fit a tool or metal sleeve on the other.

Hose Cuffs Static Conductive

Model	NSN	Threaded	Smooth	Swivel	Price
921-1616HTSC	4130-01-460-1454	1	1		
921-1620HTSC		1	1-1/4		
921-1624HTSC		1	1-1/2		
921-2020HTSC		1-1/4	1-1/4		
921-2024HTSC		1-1/4	1-1/2		
921-2416HTSC		1-1/2	1		
921-2420HTSC		1-1/2	1-1/4		
921-2424HTSC	4130-01-460-1457	1-1/2	1-1/2		
921-2424SHTSC	4130-01-460-2499	1-1/2	1-1/2	✓	
921-2432HTSC		1-1/2	2		
921-3224HTSC		2	1-1/2		
921-3232HTSC		2	2		



Hose Connectors

PVC or plastic Hose Connectors are used to connect two bare hose ends. These cuffs have a female thread to accept vacuum hose on each side.

Hose Connectors

Model	NSN	A	B	Swivel	Price
673-M12C12		3/4	3/4	✓	
673-M12C16		3/4	1	✓	
673-B0088	4730-01-519-7373	3/4	1		



Static conductive hose connectors are impregnated with carbon black to make them conductive. These connectors are used to connect two bare hose ends. They have a female thread to accept vacuum hose on each side.

Hose Connectors Static Conductive

Model	NSN	A	B	Swivel	Price
673-M16C16	4130-01-460-2496	1	1	✓	
921-1624HHSC		1	1-1/2		
921-2424SHHSC	4130-01-460-2497	1-1/2	1-1/2	✓	



* Available on GSA Advantage website @ www.GSAadvantage.gov

3/8" Compressed Air Line

- Hose terminates in 1/4" female threaded brass fittings
- Includes 1/4" high flow coupler and plug
- 300 psi max pressure

3/8" Compressed Air Line

Model	NSN	Length	Price
922-A06H10		10	
922-A06H20		20	
922-A06H30		30	
922-A06H40		40	
922-A06H50		50	



1/2" Compressed Air Line

- Hose terminates in 1/2" male threaded brass fittings
- Includes 1/2" safety coupler and plug
- Safety coupler relieves line pressure before disconnecting
- 200 psi max pressure

1/2" Compressed Air Line

Model	NSN	Length	Price
922-A08H10		10	
922-A08H20		20	
922-A08H30	4130-01-460-1337	30	
922-A08H40		40	
922-A08H50	4130-01-460-6082	50	
922-A08H60		60	
922-A08H80		80	



3/4" Compressed Air Line

- Hose terminates in 3/4" male threaded brass fittings
- Includes 3/4" safety coupler and plug
- Safety coupler relieves line pressure before disconnecting
- 200 psi max pressure

3/4" Compressed Air Line

Model	NSN	Length	Price
922-A12H10		10	
922-A12H20		20	
922-A12H30		30	
922-A12H40		40	
922-A12H60		60	
922-A12H80		80	



* Available on GSA Advantage website @ www.GSAadvantage.gov

Conductive Compressed Air Line

For use in explosive dust and gas atmospheres, these air lines feature conductive hose and all non-sparking brass and stainless steel fittings.

3/8" Conductive Compressed Air Line

- Hose terminates in 1/4" male threaded brass fittings
- Includes 1/4" all brass high flow coupler and plug
- 300 psi max pressure

3/8" Compressed Air Line Conductive

Model	NSN	Length	Price
92X-A06H10-II		10	
92X-A06H20-II		20	
92X-A06H30-II		30	
92X-A06H40-II		40	
92X-A06H50-II		50	



1/2" Conductive Compressed Air Line

- Hose terminates in 1/2" male threaded brass fittings
- Includes 1/2" all stainless steel coupler and plug
- 300 psi max pressure

1/2" Compressed Air Line Conductive

Model	NSN	Length	Price
92X-A08H10-II		10	
92X-A08H20-II		20	
92X-A08H30-II	4720-01-663-1575	30	
92X-A08H40-II		40	
92X-A08H50-II		50	



Compressed Air Line by the Foot

Get the same compressed airline we use, a la carte.

Compressed Air Line by the Foot

Model	NSN	Diameter	Rating	Price
922-H04PV-YL		1/4"	300 psi	
922-H06PV-YL		3/8"	300 psi	
922-H08PV-BL		1/2"	200 psi	
922-H12PV-RD		3/4"	200 psi	
922-H16PV-RD		1"	200 psi	
922-H06CD-RD*		3/8"	300 psi	
922-H08CD-RD*		1/2"	200 psi	

* = Conductive



* Available on GSA Advantage website @ www.GSAadvantage.gov

Fittings

Clayton standardizes on the finest in pneumatic connectors. High Flow (HF) Series 1/4" couplers are engineered to allow twice the flow of comparably-sized standard Industrial Interchange (II) design couplers and connectors. One handed push-to-connect design allows easy operation. Fittings 1/2" and higher are designed with safety first. These large couplers are designed to depressurize the compressed air line before disconnecting. This eliminates the dangers associated with the quick release of high pressure lines.

Couplers

Fittings 1/2" and higher are designed with safety first. These large couplers are designed to depressurize the compressed air line before disconnecting. This eliminates the dangers associated with the quick release of high pressure lines.

Compressed Air Line Couplers

Model	NSN	Plug Side	Thread Size	Type	Price
940-12CM-PS		3/4"	3/4" MNPT	II	
940-12CF-PS		3/4"	3/4" FNPT	II	
940-08CM-PS		1/2"	1/2" MNPT	II	
940-08CF-PS	4130-01-460-2502	1/2"	1/2" FNPT	II	
940-08CF-SS		1/2"	1/2" FNPT	II SS	
940-011	4730-01-520-5799	1/4"	1/4" MNPT	II & HF	
940-011F		1/4"	1/4" FNPT	II & HF	

II = Industrial Interchange HF=High Flow SS=Stainless Steel



Plugs

Plugs are available in 1/4" high flow series, or in all sizes of Industrial Interchange.

Compressed Air Line Plugs

Model	NSN	Plug Side	Thread Size	Type	Price
940-12PM		3/4"	3/4" MNPT	II	
940-12PF		3/4"	3/4" FNPT	II	
940-08PM		1/2"	1/2" MNPT	II	
940-08PF	4130-01-460-2504	1/2"	1/2" FNPT	II	
940-08PM-SS		1/2"	1/2" MNPT	II SS	
940-08PF-SS		1/2"	1/2" FNPT	II SS	
940-016	4730-01-519-7442	1/4"	1/4" MNPT	HF	
940-04PM-II		1/4"	1/4" MNPT	II	
940-04PM-HFB		1/4"	1/4" MNPT	HF	
940-04PM-IIB		1/4"	1/4" MNPT	II	

II = Industrial Interchange HF=High Flow SS=Stainless Steel

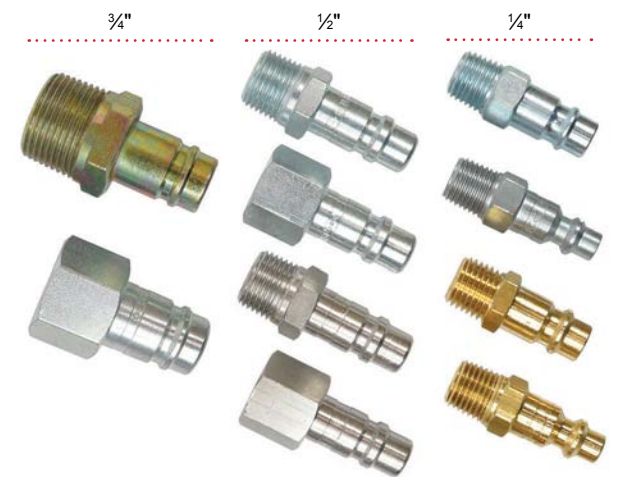

Ball Valves

Nickel plated ball valves incorporate a zero-resistance full bore design to maximize air flow. Oversize handles provide the leverage needed to shut down larger valves.

Ball Valves

Model	NSN	In	Out	Type	Price
924-1002	4820-01-520-3609	1" FNPT	1" FNPT	II	
924-0752		3/4" FNPT	3/4" FNPT	II	



* Available on GSA Advantage website @ www.GSAadvantage.gov

Brass Nipples

Nipples are designed with a central hex to make installation and removal a breeze.

Nipples

Model	NSN	A	B	Price
918-8HN		1/2" NPT	1/2" NPT	
918-12HN		3/4" NPT	3/4" NPT	
918-16HN		1" NPT	1" NPT	



Brass Bulkhead Fittings

These fittings provide a means to bridge an air supply cleanly across a wall or partition. Galvanized lock washers ensures a secure installation.

Bulkhead Fittings

Model	NSN	A	B	Price
918-04BH		1/4" NPT	1"	
918-06BH		3/8" NPT	3/4"	
918-08BH		1/2" NPT	1"	
918-12BH		3/4" NPT	1"	

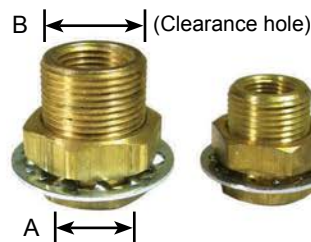

Brass Reducing Bushings

Adapt easily from one size pipe thread to another with these durable NPT bushings.

Bushings

Model	NSN	A	B	Price
918-06B04		1/4" NPT	3/8" NPT	
918-08B04		1/4" NPT	1/2" NPT	
918-08B06		3/8" NPT	1/2" NPT	
918-12B04		1/4" NPT	3/4" NPT	
918-12B06		3/8" NPT	3/4" NPT	
918-12B08		1/2" NPT	3/4" NPT	
918-16B08		1/2" NPT	1" NPT	
918-16B12		3/4" NPT	1" NPT	

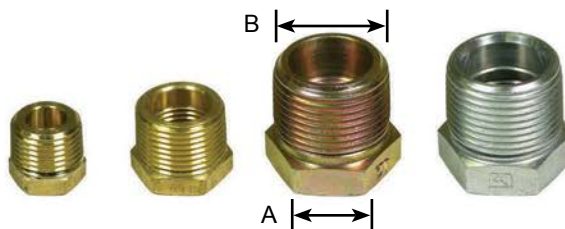

Brass Tees

Split a compressed air line easily with these Tees and Reducing Tees.

Tees

Model	NSN	A	B	C	Price
918-04T		1/4" NPT	1/4" NPT	1/4" NPT	
918-08T		1/2" NPT	1/2" NPT	1/2" NPT	
918-12T		3/4" NPT	3/4" NPT	3/4" NPT	
918-16T		1" NPT	1" NPT	1" NPT	
918-16RT1212		3/4" NPT	3/4" NPT	1" NPT	

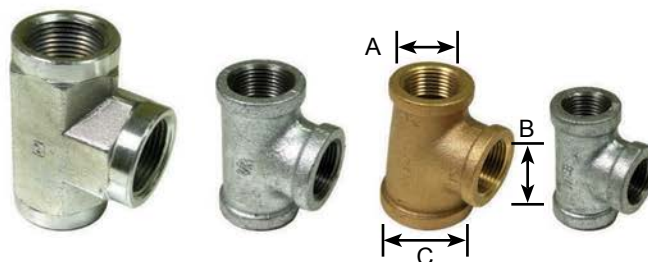

* Available on GSA Advantage website @ www.GSAadvantage.gov

Clayton 3 Port Distribution Module

This Distribution module is based upon the needs expressed to us by the maintainers of the C-17.

The need was for 2-3 maintainers to perform dustless sanding operations at a great distance from the vacuum - up to 80 feet away. The distribution module allows 3 simultaneous users to work from one vacuum with a negligible loss of suction. The module is paired with any one of our 2" Air / Vac Cam Lock hoses. Maintainers can simply plug their lightweight Clayton Work Hoses and airlines directly into the distribution module, and work up to a 30 foot radius around the module. The module distributes the vacuum suction and the compressed air. This module is often used on JLG lifts or scissor-style lifts, and its integral bracket and safety cable allows it to be hung from the railing of the lifts. It works equally well on maintenance stands or scaffolding. Some customers find that the module allows maintainers to work inside an aircraft comfortably, without having to maneuver the vacuum into the fuselage. This module can be fitted to any Clayton HEPA Vacuum.

- Allows 3 maintainers to work simultaneously from one vacuum
- Extends vacuum range up to 80' (total length 110')
- Can be used with any brand vacuum (depending on vacuum strength)
- Lightweight aluminum construction - 12 lbs. total
- Attached dust cap prevents dust from escaping module when not in use
- Safety cable secures module to railings or structural components
- Integrated carry handle



Distribution Module

Model	NSN	Vac Ports	Air Ports	Price
923-A20315		3	3	
923-A20315-0*		3	3	
923-A20315-4**		3	3	

* includes hose whip for electric DustMaster Vac

** includes hose whip for pneumatic DustMaster Vac

2" Combination Air / Vac Cam Lock to Sleeve Hoses

Model	NSN	Vac Hose	Air Hose	Length	Price
671-AVH2020X		2"	1/2"	20'	
671-AVH2040X		2"	1/2"	40'	
671-AVH2060X		2"	1/2"	60'	
671-AVH2080X		2"	1/2"	80'	

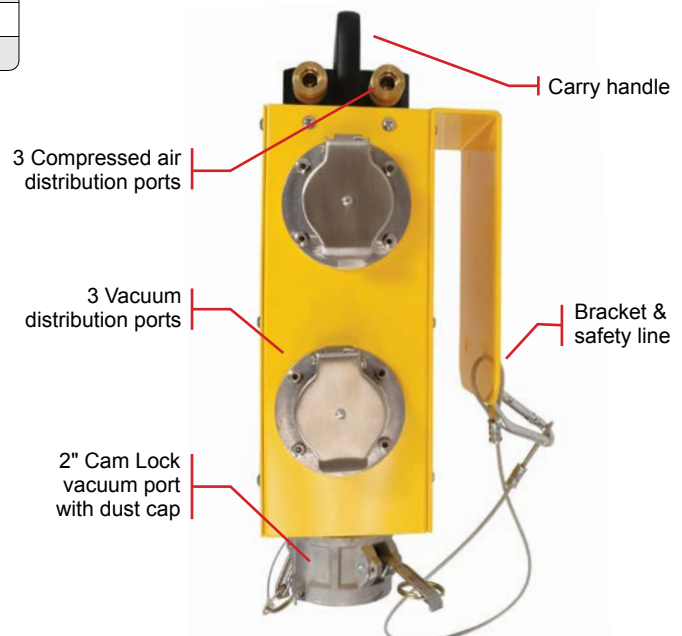
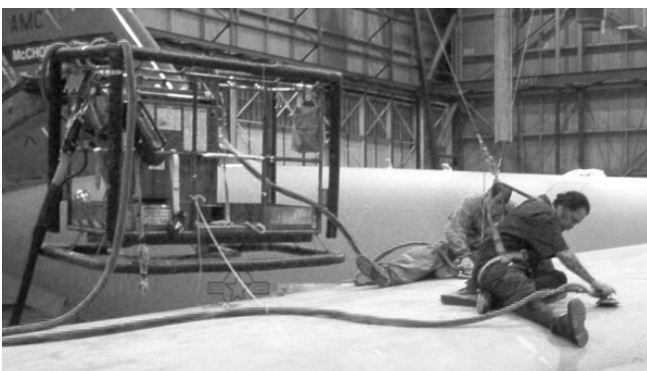

NOTE: This module works in conjunction with a vacuum and requires a 2" Clayton cam lock hose and provides passive distribution only.

★ Available on GSA Advantage website @ www.GSAadvantage.gov

Clayton Distribution Rover

The module is paired with any one of our 2" Air / Vac Cam Lock hoses. Maintainers can simply plug their lightweight Clayton Work Hoses and airlines directly into the Rover, and work up to a 30 foot radius around it. The Rover distributes the vacuum suction and compressed air to 4 users. This module can be fitted to any Clayton Central Vacuum.

- Allows 4 maintainers to work simultaneously from one vacuum
- Extends vacuum range up to 100' (total length 130')
- Can be used with any brand vacuum (depending on vacuum strength)
- Attached dust cap prevents dust from escaping module when not in use

Distribution Rover

Model	NSN	Vac Ports	Air Ports	Price
923-A20415		4	4	

2" Combination Air / Vac Cam Lock to Cam Lock Hoses

Model	NSN	Vac Hose	Air Hose	Length	Price
671-AVHC32-40		2"	3/4"	40'	
671-AVHC32-60		2"	3/4"	60'	
671-AVHC32-80		2"	3/4"	80'	
671-AVHC32-100		2"	3/4"	100'	

★ Available on GSA Advantage website @ www.GSAadvantage.gov

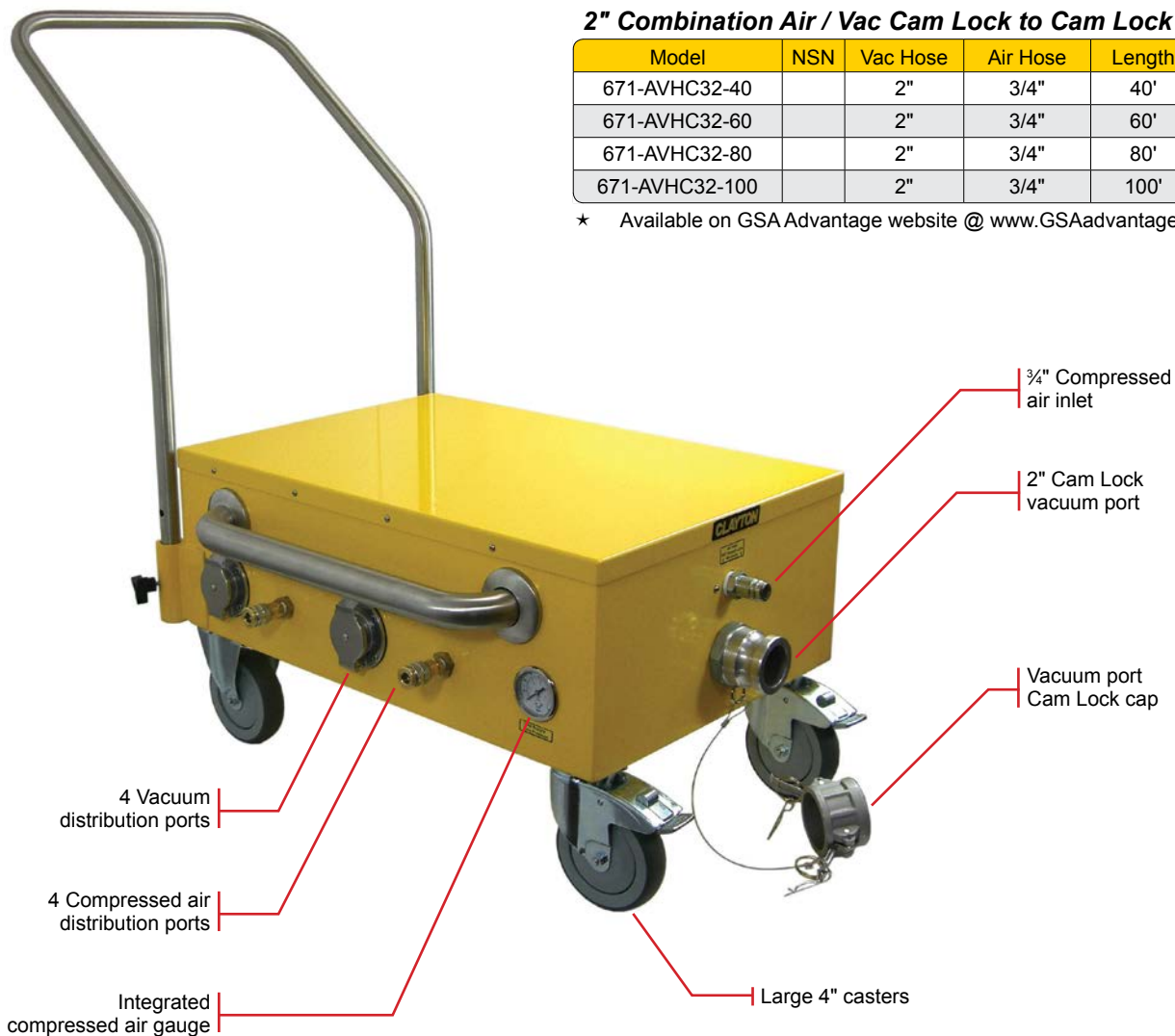

AutoGate Air Tool Activated Gate Valve

Central vacuum hoses left connected and open when not in use are an unnecessary drain on central vacuum resources. They reduce the amount of vacuum available for other users and prevent VFDs from cycling down your vacuum producer to provide the savings you expected from them.

Our Automatic Gate Valve for central vacuums is designed for operations like vacuum sanding where an air tool requires vacuum for dust collection. It fits between each vacuum port and the tool hose. When the air tool is activated the gate valve opens. When the air tool is deactivated the gate valve closes with a time delay up to 60 secs.

Features

- 1-1/2in vacuum inlet/outlet
- 1/4in compressed air inlet/outlet
- Delay timer (0 to 60 secs)
- Auto or Manual on/off
- Magnetic or screw in wall mount

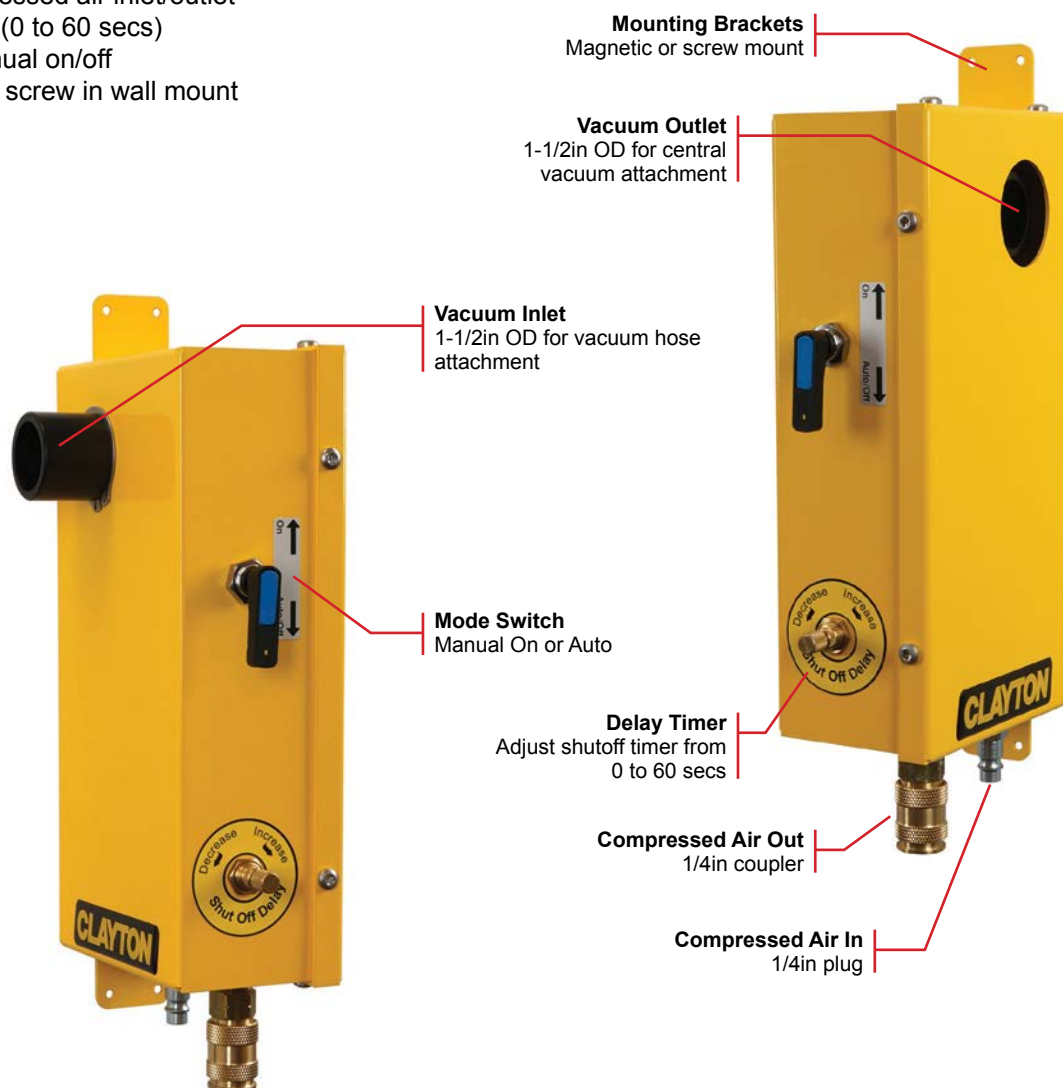

AutoGate

Model	NSN	Description	Price
924-AG24		Auto Gate Valve, 1-1/2in x 1/4 in air	

* Available on GSA Advantage website @ www.GSAadvantage.gov

Hose Support Belt

Support the weight of long vacuum hoses from the waist.... Not from the arm.

Eliminates having a long, heavy hose hanging from the sander, the principal objection to using vacuum sanders voiced by workers.

Ideal for workers sanding aircraft, ships or structures from elevated positions.

Two sizes available

671-HSB1000W - Fits most waists 29" to 46"

671-HSB2000W - Fits most waists 46" to 56"



Performance

- Light weight, 1" vacuum hose & 3/8" compressed air line extend from the belt to the sander
- Quick disconnect fittings at each end make changing tools hassle-free and fast

Comfort

- 5" wide padded belt is firm yet flexible enough to be comfortable
- Made of heavy duty, double weight nylon, it will not rot, crack, harden or mildew
- 2" double tongue, metal roller buckle makes it easy to put on and off
- Cloth strap holds hose to the arm for ease of movement

Safety

- Allows workers to release their grip on the sander and use both hands to grip railings when climbing stairs or ladders
- Minimizes worker fatigue, a major contributor of work-related accidents

Velcro Belts have no metal buckles and will not scratch work surfaces.

Hose Support Belts

Model	NSN	Description	Vac Hose	Air Hose	Length	Price
671-HSB1000W		Hose Support Belt 29-46 Waist	1"	3/8"	5'	
671-HSB2000W		Hose Support Belt 46-56 Waist	1"	3/8"	5'	
671-HSB1001W		Hose Support Belt SML Waist - Velcro	1"	3/8"	5'	
671-HSB2001W		Hose Support Belt XL Waist - Velcro	1"	3/8"	5'	

★ Available on GSA Advantage website @ www.GSAadvantage.gov



Workers on the job with Clayton Hose Support Belts

Clean Up Tools

We provide a variety of attachments for general clean up, sold as kits or individually. Each kit includes an aluminum two piece wand for tool attachment. Heavy duty tools are all metal while some light duty tools are ABS or poly.

5 piece light duty toolkit (pull pin)

630-A001

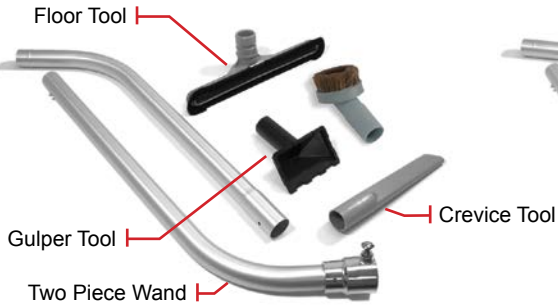

5 piece heavy duty toolkit (pull pin)

630-A002

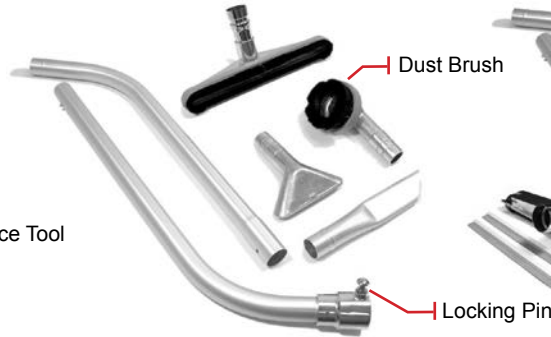

5 piece wheeled toolkit (pull pin)

630-A003

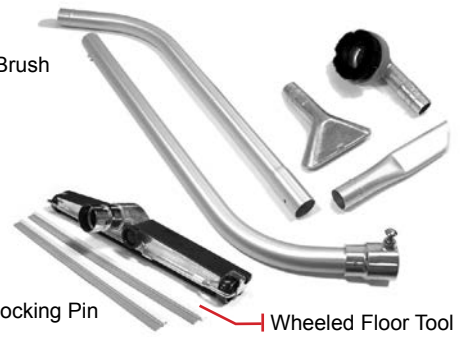

4 piece wet pickup toolkit (pull pin)

630-A010

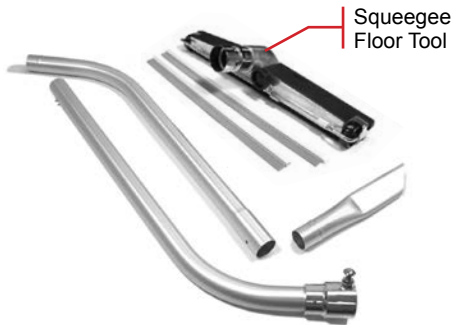

5 piece light duty toolkit (collar ring)

630-A011



2 piece FOD toolkit (friction fit)

630-A006

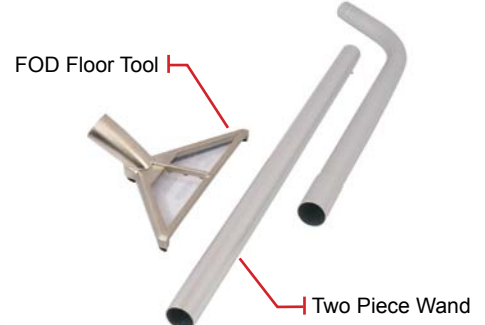

Clean Up Tool Kits

Model	NSN	Description	Price
630-A000		Wall Mount Tool Control Rack	
630-A001		Clean Up Toolkit - 5 Piece Light Duty	
630-A002		Clean Up Toolkit - 5 Piece Heavy Duty	
630-A003		Clean Up Toolkit - 5 Piece Heavy Duty Wheeled	
630-A006	4130-01-503-9115	Clean Up Toolkit - FOD Floor Tool & Wand	
630-A010		Clean Up Toolkit - Wet Pickup	
630-A011	4130-01-492-6049	Cleanup Toolkit - FOD Collection	



Hand Held Cuff Clean Up Tools

Our light duty tools are made from impact resistant nylon or polyethylene. Brushes are typically not replaceable. Pin Lock Wand has no loose parts that can become a FOD hazard.

Cuff Tools

Model	NSN	Description	Price
642-20T11001		Turbine Brush - 11in Cuff Style	
642-24G04001		Gulper Tool - Poly Duckbill 1.5in x 4in	
642-24G05001		Gulper Tool - Poly 1.5in x 5in	
642-24G05002	4130-01-508-6528	Personnel Cleanup Brush	
642-24G05003		Gulper Tool - Poly with Bristles 1.5in x 5in	
642-24G05003-1		Gulper Tool - Poly No Bristles 1.5in x 5in	
642-24G05003-2		Replacement Bristles for Gulper Tool	
642-24G06101		Gulper Tool - Alum 1.5in x 6in	
642-24G18101	4130-01-494-2018	Bulk Pickup Tool - 1.5 x 18 Aluminum	
642-24N09101	4130-01-492-6050	Rubber Nozzle - 1.5in x 9in	
642-24N22101		Rubber Nozzle - 1.5in x 22in	
642-24R03001		Dust Brush - Poly 1.5in x 3in Horsehair	
642-24R03002	4130-01-459-1321	3in Round Vacu-Dus Brush (1in FHT)	
642-24R03101		Dust Brush - Alum 1.5in x 3in Horsehair	
642-24R03101-1		Bristles for 3in Alum Dust Brush Horsehair	
642-24R03102		Dust Brush - Alum 1.5in x 3in Conductive Bristles	
642-24R03102-1		Bristles for 3 in Dust Brush (Conductive)	
642-24R05101		Dust Brush - Alum 1.5in x 5in Horsehair	
642-24R05101-1		Bristles for 5in Dust Brush Horsehair	
642-24V11001	4130-01-459-1427	Crevice Tool - Poly 1.5in x 11in	
642-24V11002		Crevice Tool - Poly 1.5in x 11in Wide	
642-24V11101		Crevice Tool - Alum 1.5in x 11in	
642-24V11102		Crevice Tool - Alum 1.5in x 11in (Conductive)	
642-24V17001		Crevice Tool - Poly 1.5in x 17in Wide	
642-24V24101	4130-01-494-2015	Crevice Tool - Alum 1.5in x 24in	
642-24V24102		Crevice Tool - Alum 1.5in x 24in (Conductive)	



Wand & Tools (Pull Pin Style)

Pull pin style wands have no loose parts to become FOD.



These tools are specifically designed with no loose parts that can inadvertently come off and become FOD.

Wand Tools - Pull Pin

Model	NSN	Description	Price
642-24D56101		Wand - Aluminum 2 PC 2-Bend 1.5in x 56in (Pull Pin)	
642-24F14001		Floor Tool - Poly 1.5in x 14in Nylon Bristles (Pull Pin)	
642-24F14101		Floor Tool-Alum 1.5in x 14in Nylon Bristles (Pull Pin)	
642-24F14101-1		Bristles for 14in Alum Floor Tool	
642-24F18101		Floor Tool - Alum 1.5in x 18in Wheeled (Pull Pin)	



Wand & Tools (Collar Ring Style)

Wand Tools - Collar Ring

Model	NSN	Description	Price
642-24C14001		Floor Tool - Poly Scallop Edge 14in	
642-24D56102	4130-01-500-6102	Wand - Aluminum 2-Bend Telescoping (collar ring)	
642-24D56103		Wand - Conductive Alum 2 PC 2-Bend 1.5in x 56in (Collar Ring)	
642-24D56104	4130-01-459-1424	Wand - Aluminum 2 PC 2-Bend 1.5in x 56in (collar ring)	
642-24F14102		Floor Tool - Conductive 1.5in x 14in Nylon Bristle (Collar Ring)	
642-24F20001	4130-01-503-9104	Floor Tool - Poly 1.5in x 20in Nylon Bristles (collar ring)	
642-24F14103		Floor Tool - Alum 1.5in x 14in Nylon Bristles (collar ring)	



Wand & Tools (Friction Fit)

Wand Tools - Friction Fit

Model	NSN	Description	Price
642-24D54101	4130-01-483-1891	Wand - Aluminum 2 PC 1-Bend 1.5in x 54in (friction fit)	
642-24F12001	4130-01-459-1433	FOD Floor Tool, Aluminum 1.5in x 12 (friction fit)	
642-24F12001-1		Bristles - Horse Hair for FOD Floor Tool	
642-24F14002	4130-01-492-6048	Floor Tool - Poly 1.5in x 14in Nylon Bristles (friction fit)	



F12001



F14002



D54101

Overhead Cleaning Wand & Tools

Overhead Cleaning - Collar Ring

Model	NSN	Description	Price
642-24D60101		Wand - Aluminum 1 Piece Ext 1.5in x 60in (Collar Ring)	
642-24P04001		Overhead Pipe Brush - Poly 1in to 4in Diameter (collar ring)	
642-24P08001		Overhead Pipe Brush - Poly 4in to 8in Diameter (collar ring)	
642-24W10101		Wall Brush - Alum 1.5in x 10in (collar ring)	



D60101



P08001

P04001



W10101

High Capacity Wand & Tools

2in Tools

Model	NSN	Description	Price
642-32D50101		Wand - Steel 1pc 2in x 50in	
642-32F20101		Floor Tool - Alum 2in x 20in Wheeled	
642-32V15101		Crevice Tool - Alum 2in x 15in	



D50101



F20101



V15101

Flexible Crevice Tools

Our Flex-Loc crevice tools can be bent into any position and stay there. They come standard with a 1" female hose thread for connection to our 1" vacuum hose. Great for FOD cleanup!

FOD Wands

Model	NSN	Description	Price
500-415-1	4720-01-671-0189	FOD Wand 1/2in x 1in x 18in (18 element)	
500-415-0816B		FOD Wand 1/2in x 1in x 18in (18 element) with Brushes	
500-428-0816		FOD Wand 1/2in x 1in x 24in (28 element)	
500-438-0816		FOD Wand 1/2in x 1in x 36in (38 element)	
500-424-0416		FOD Wand 1/4in x 1in x 18in (24 element)	
500-464-0416		FOD Wand 1/4in x 1in x 36in (64 element)	
500-415-1216	4130-01-478-3108	FOD Wand 3/4in x 1in x 18in (15 element)	
500-424-1216		FOD Wand 3/4in x 1in x 24in (24 element)	
500-439-1216		FOD Wand 3/4in x 1in x 36in (39 element)	
500-427-4032		Snorkel 2-1/2in x 3ft x 2in Cuff	



- 3' Flex-Loc Snorkel with Gate Valve
- 3 Interchangeable Nozzles
- Magnetic Mount for pedestal tool dust capture



Mountable Crevice Tools

Our Flex-Loc crevice tools with 1in vacuum hose can be mounted with either a suction cup for flat smooth surfaces or a spring clamp.

FOD Wands

Model	NSN	Desc	Price
551-415-1216		FlexLoc Wand & Hose 3/4in x 1in x 18in	
551-415-1216C		FlexLoc Wand 3/4in x 1in x 18in Clamp Mount	
551-415-1216S		FlexLoc Wand 3/4in x 1in x 18in Suction Cup Mount	
551-415-1216VC		FlexLoc Wand 3/4in x 1in x 18in Valve & Clamp Mount	
551-415-1216VS		FlexLoc Wand 3/4in x 1in x 18in Valve & Suction Cup Mount	
551-RAMB2241U1		RAM Twist Lock Suction Cup Base	
551-RAMB231ZU		RAM Small UBolt	
551-RAPB201UA		RAM Short Arm Composite	
551-RAPB3972U		RAM Large Tough Clamp	
551-RAPB400U		RAM Small Claw	



- 3/4" x 18" Flex-Loc Wand
- Suction Cup Mount
- Clamp Mount
- 2' Hose Whip

Magnetic Quick Disconnect for Tools & Hoses

Made of carbon fiber reinforced nylon, these hose connectors allow tools and hoses to be disconnected quickly and easily. Strong neodimium magnets provide a secure connection but release with a simple twist.

Hose Connectors Static Conductive

Model	NSN	Desc	Price
673-Q16C16		Magnetic Quick Disconnect 1in to 1in Hose	
673-Q16M		Magnetic Quick Connect Male (1in FHT Tool Side)	
673-Q16F		Magnetic Quick Connect Female (1in FHT Vacuum Side)	
673-Q12M		Magnetic Quick Connect Male (3/4in FHT Tool Side)	
673-Q12MT		Magnetic Quick Connect Male (3/4in FNPT Tool Side)	
673-Q20F		Magnetic Quick Connect Female (1-1/4in FHT Vacuum Side)	

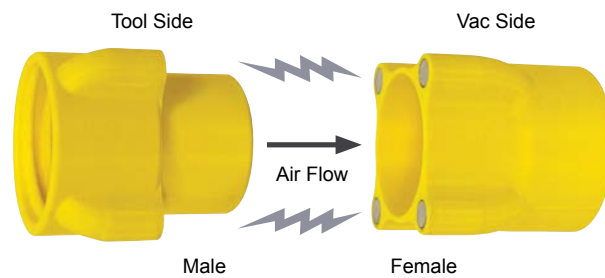

Tool Side Options

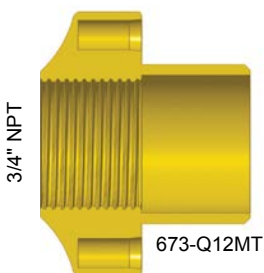
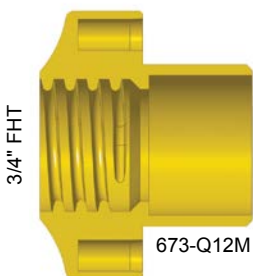
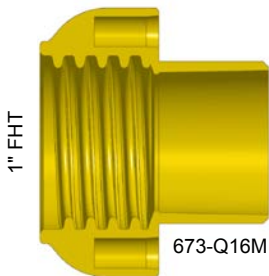

Vacuum Side Options

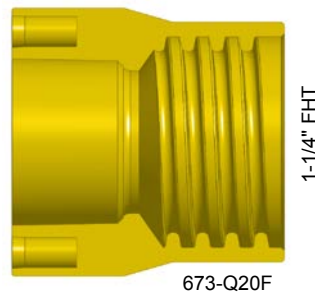
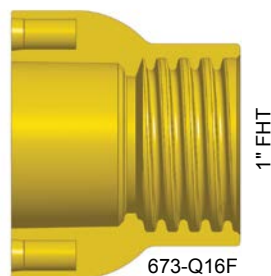

Features

- N52 Neodimium magnets
- 1in Female Hose Thread

Hose to Hose

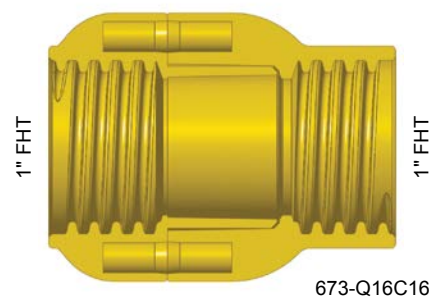

FILTERS

Bag Filters • Prefilters • HEPA Filters • Air Filters

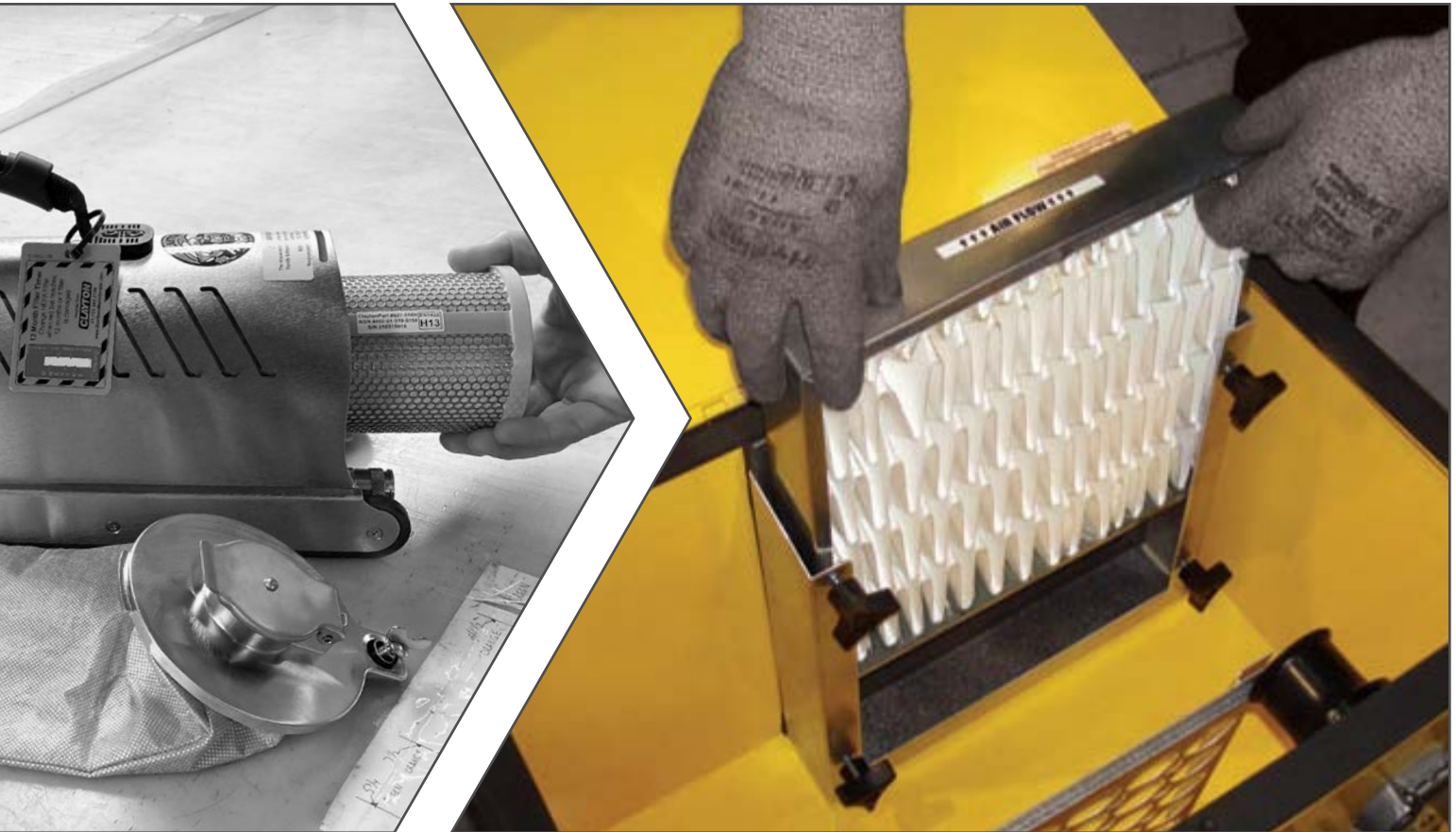

Filters 101

It is important to note that just because a filter uses HEPA media, it may not provide HEPA filtration. This is because High Efficiency filters are rated at specific maximum flow rates. A given HEPA filter may be rated HEPA at a maximum of 150 CFM but would not be rated HEPA at 200 CFM. It is important to make sure the filter being used is designed and rated for the flow rate it needs to handle.

All Clayton HEPA, ULPA, and MERV rated filters are designed to work in specific vacuums and are not interchangeable.

HEPA

HEPA filters are composed of a mat of randomly arranged fibers. The fibers are typically composed of fiberglass and possess diameters between 0.5 and 2.0 micrometers. Key factors affecting function are fiber diameter, filter thickness, and face velocity. The air space between HEPA filter fibers is much greater than 0.3 μm . The common assumption that a HEPA filter acts like a sieve where particles smaller than the largest opening can pass through is incorrect. Unlike membrane filters at this pore size, where particles as wide as the largest opening or distance between fibers cannot pass in between them at all, HEPA filters are designed to target much smaller pollutants and particles. These particles are trapped (they stick to a fiber) through a combination of the following three mechanisms:

1. Interception, where particles following a line of flow in the air stream come within one radius of a fiber and adhere to it.
2. Impaction, where larger particles are unable to avoid fibers by following the curving contours of the air stream and are forced to embed in one of them directly; this effect increases with diminishing fiber separation and higher air flow velocity.
3. Diffusion, an enhancing mechanism that is a result of the collision with gas molecules by the smallest particles, especially those below 0.1 μm in diameter, which are thereby impeded and delayed in their path through the filter; this behavior is similar to Brownian motion and raises the probability that a particle will be stopped by either of the two mechanisms above; it becomes dominant at lower air flow velocities.

Diffusion predominates below the 0.1 μm diameter particle size. Impaction and interception predominate above 0.4 μm . In between, near the most penetrating particle size (MPPS) 0.3 μm , both diffusion and interception are comparatively inefficient. Because this is the weakest point in the filter's performance, the HEPA specifications use the retention of these particles to classify the filter.

Lastly, it is important to note that HEPA filters are designed to arrest very fine particles effectively, but they do not filter out gases and odor molecules. Circumstances requiring filtration of volatile organic compounds, chemical vapors, cigarette, pet, and/or flatulence odors call for the use of an activated carbon (charcoal) filter instead of or in addition to a HEPA filter.

	Class	retention (total)	retention (local)
	E10	> 85%	---
	E11	> 95%	---
	E12	> 99.5%	---
HEPA	H13	> 99.95%	> 99.75%
	H14	> 99.995%	> 99.975%
ULPA	U15	> 99.9995%	> 99.9975%
	U16	> 99.99995%	> 99.99975%
	U17	> 99.999995%	> 99.9999%

HEPA filters, as defined by the DOE standard adopted by most American industries, remove at least 99.97% of airborne particles 0.3 micrometers (μm) in diameter. The filter's minimal resistance to airflow, or pressure drop, is usually specified around 300 Pa at its nominal flow rate.

The specification usually used in the European Union is the European Norm EN 1822:2009. It defines several classes of HEPA filters by their retention at the given most penetrating particle size (MPPS):

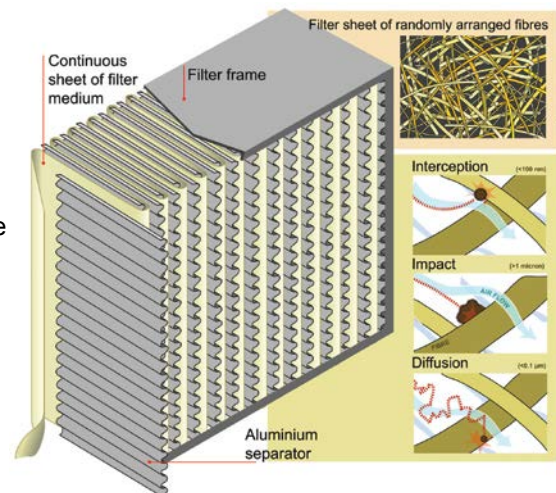

ULPA

ULPA is an acronym for Ultra Low Penetration Air or Ultra Low Particulate Air. An ULPA filter can remove at least 99.99% of airborne particles 0.12 μm or larger.

Filters 101

MERV

The Minimum Efficiency Reporting Value or MERV rating, is a measurement scale designed in 1987 by the American Society of Heating, Refrigerating and Air-Conditioning Engineers (ASHRAE) to rate the effectiveness of air filters. The scale represents a quantum leap in the precision and accuracy of air-cleaner ratings and allows for improved health, reduced cost and energy efficiency in heating, ventilation and air conditioning (HVAC) design. For example, a HEPA filter is often impractical in central HVAC systems due to the large pressure drop the dense filter material causes. Experiments indicate that less obstructive, medium-efficiency filters of MERV 7 to 13 are almost as effective as true HEPA filters at removing allergens, with much lower associated system and operating costs.

The scale is designed to represent the worst case performance of a filter when dealing with particles in the range of 0.3 to 10 μm . The MERV rating is from 1 to 20. Higher MERV ratings correspond to a greater percentage of particles captured on each pass, with a MERV 16 filter capturing more than 95% of particles over the full range.

MERV	Min particle size	Typical controlled contaminant	Typical Application
17–20	< 0.3 μm	Virus, carbon dust, sea salt, smoke	Electronics & pharmaceutical manufacturing cleanroom
13–16	0.3–1.0 μm	Bacteria, droplet nuclei (sneeze), cooking oil, most smoke and insecticide dust, most face powder, most paint pigments	hospital & general surgery
9–12	1.0–3.0 μm	Legionella, Humidifier dust, Lead dust, Milled flour, Auto emission particulates, Nebulizer droplets	Superior residential, better commercial, hospital laboratories
5–8	3.0–10.0 μm	Mold, spores, dust mite debris, cat and dog dander, hair spray, fabric protector, dusting aids, pudding mix	Better residential, general commercial, industrial workspaces
1–4	> 10.0 μm	Pollen, dust mites, cockroach debris, sanding dust, spray paint dust, textile fibers, carpet fibers	Residential window AC units

While the smallest MERV value in each row has no minimum requirement for filtering that row's particle size, it does have stricter requirements for all larger particle sizes than any smaller MERV value. For example, MERV 13 the "0.3–1.0 μm " row has no minimum requirement for removing 0.3–1.0 μm particles (the standard specifies "<75%") but has higher minimum removal percentages of 1.0–3.0 μm , 3.0–10.0 μm , and > 10 μm particles than MERV 12 and all smaller MERV values. All other MERV values on each row do have minimum removal percentages for that row's particle size.

HEPA Filters

Clayton High Efficiency Particulate Air (HEPA) are engineered to provide maximum protection from hazardous dust. HEPA filters capture 99.97% of particles 0.3 µm or larger. These filters are the ideal solution when working with chromated primers, lead paints, or composites.

HEPA Filters

Model	NSN	Description
627-12H	4310-01-520-6794	HEPA Filter Warthog
627-12HX		HEPA Filter Conductive Stingray
627-12C		HEPA Filter Coalescing Hydrophobic Barracuda
600-116	4310-01-519-5796	Hepa Filter, Dustmaster, 1 Pk
627-516H	4460-01-519-5158	HEPA Filter for Hornet / Scorpion



627-516H



627-12H



600-116

Pre-Filters

Clayton Pre-filters have been designed to prolong the life of the HEPA filters. Pre-filters provide protection from larger particles which might escape when a bag filter is installed incorrectly or has sustained damage.

Pre-filters

Model	NSN	Description	Price
627-12P		PreFilter Warthog 3pk	
627-516P		Prefilter Scorpion HEPA	
600-115	4310-01-519-5205	Pre-Filter, DM Vacs, 3 Pk	



627-516P



627-12P



600-115

Bag Filters

Disposable bag filters are the first stage of filtration on most Clayton vacuums. These vacuum bags are designed to capture larger particles and debris. Most are manufactured with a lining to resist 'caking' of dust on the inside of the bag. Bag filters are intended for single use.

Bag Filters

Model	NSN	Description	Price
600-313A	7910-01-520-6435	Filter Bag, Dustmaster Main Compartment 5 Pk	
610-313A	4310-01-520-8595	Filter Bag Cyclone 10 Pk	
627-16B	7910-01-459-0352	Filter Bag, 15gal Warthog 5pk	
627-0913B	4130-01-459-1257	Filter Bag 5 Gal Poly 5 Pak	
627-1414B		Filter Bag 5 Gal Steel 5 Pak	
627-1218M10		Filter Sock Barracuda 12 x 18 x 1mu, 5 pk	



600-313A



610-313A



627-0913B



627-1414B



627-16B

Bag Filters Conductive

Model	NSN	Description	Price
627-16BC		Filter Bag, 15 Gal Conductive, 5 Pk	
627-1414BC		Filter Bag, 5 Gal Conductive, 5 Pk	
690-A0031	4460-01-519-5125	Filter Bag, Super Hornet, 10 Pk	



627-1414BC



627-16BC

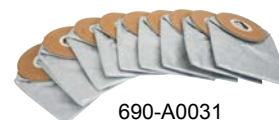

690-A0031

* Available on GSA Advantage website @ www.GSAadvantage.gov

Timer Cards

Clayton Timer Cards are credit card size, tamper-proof tags that are irreversibly activated by finger pressure. Once 'ON' a safe dye migrates along a display window, showing elapsed time in a range from 1 to 12 months.

The patented technology has no moving parts, requires no power source and is accurate to within a few hours.

They offer an accurate and reliable visual reminder of service and maintenance schedules to ensure optimum performance of equipment that needs service or consumable replacement at specific intervals.

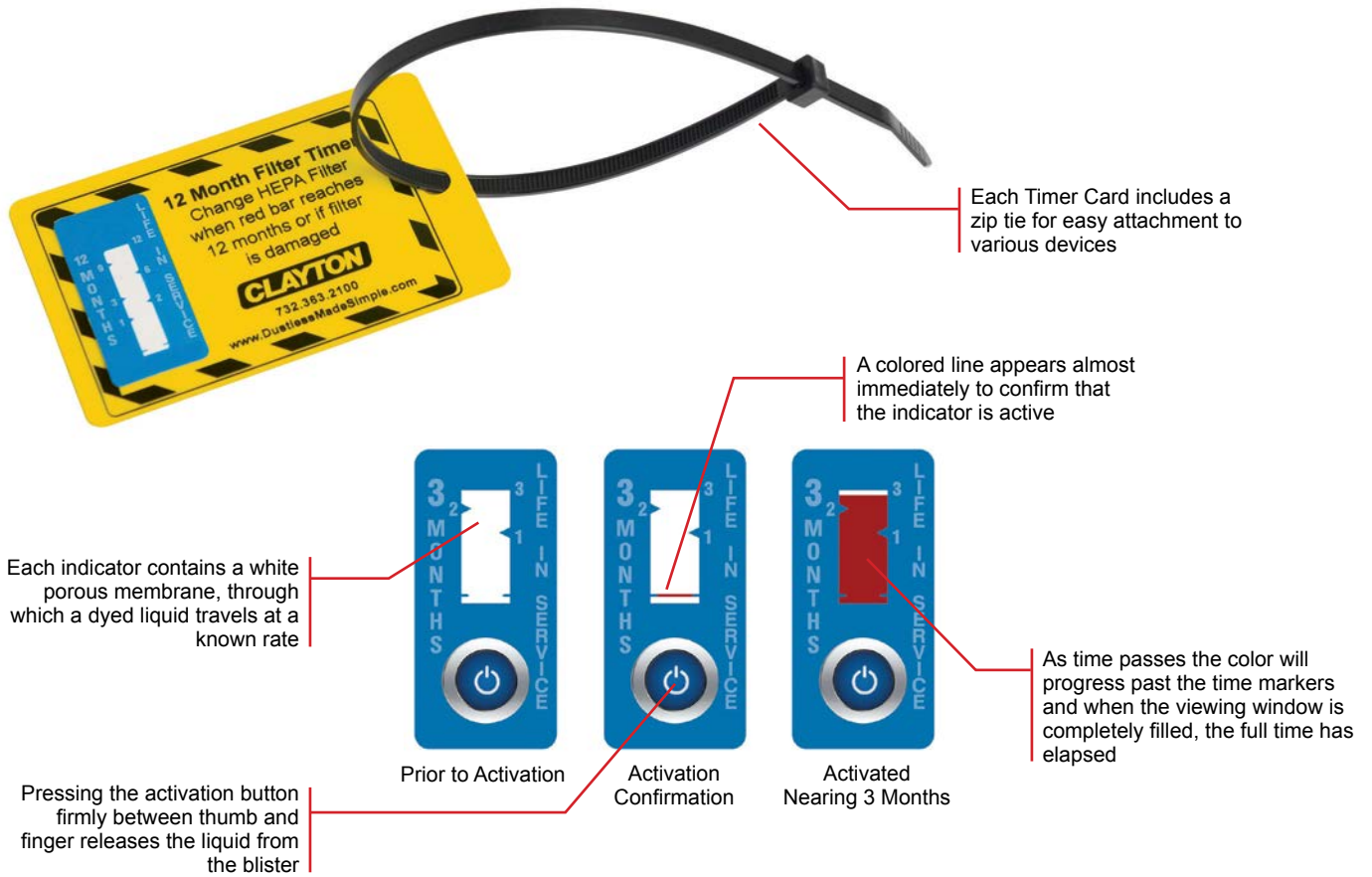

HEPA Timer Cards

Model	NSN	Desc	Price
627-T12H	4330-01-633-7988	12 Month	



Service Required Timer Cards

Model	NSN	Desc	Price
627-T01S		1 Month	
627-T03S		3 Month	
627-T06S		6 Month	
627-T12S		12 Month	



CLEANING PRODUCTS & FIELD REPAIR



Hygenall HexOff

The **ONLY** product in the world, specifically designed to remove toxic heavy metals from the skin and other surfaces.

HexOff
The science of clean

Manufactured and sold under license from the Centers for Disease Control and Prevention (CDC).

Soap products are terrific at dissolving dirt, but Hex Chrome is not dirt. Hex Chrome is a heavy metal and sticks to skin and surfaces through a strong electromagnetic bond. HexOff works by breaking the bond and allowing Hex Chrome and other heavy metals to be washed off.

Hexavalent Chromium CrVI is a toxic form of the element chromium. Hexavalent chromium is rarely found in nature and is generally man-made. CrVI is used in a wide variety of industrial activities, including welding, manufacture of stainless steel, pigment and painting applications, electro plating, and Anti-Corrosion Coatings. Hexavalent chromium can be formed when performing "hot work" such as welding on stainless steel or melting chromium metal. In the US according to the OSHA there are over 558,000 workers exposed to Hexavalent Chromium each year.

Cutting, grinding, and welding may expose workers to the following toxic heavy metals:

- Calcium Chromate – Corrosion inhibitor, pigments and depolarizer in batteries
- Chromium Trioxide - Chromium plating, aluminum anodizing, chemical conversion coatings, corrosion inhibitors
- Cobalt Chromium Alloys – Jet Engine Turbine discs and blades, and nozzle vanes
- Aluminum, Titanium and Copper alloys - Controls microstructure
- Stainless Steel Parts - Contain between 12% to 36% Chromium
- Barium Chromate - Ceramics, metal primers and ignition control devices
- Zinc Chromates – Used as pigment in paints & coatings. Used as corrosion-resisting primers and metal conditioners
- Cadmium Chloride– Used in electroplating
- Chromium Cyanide – Used to inhibit corrosion
- Cadmium Hydroxide– Found in NiCad batteries
- Cadmium Oxide – Used in Chrome Plating Baths, Ceramic Glazes, Electrodes, and Pigmentations
- Cadmium Iodine- Used in electroplating
- Cadmium Sulfate – Used in electronic circuits
- Cadmium Sulfide– Used as pigment in paints, and Plastics
- Cadmium Fluoride- Used in production of metallic alloys such as bearings

The technology in Hygenall HexOff was developed, tested, and patented by the U.S. Centers for Disease Control and Prevention (patent number: 7,604,997 B2) specifically for removing CAD ++ metals like Hexavalent Chromium.

The CDC is the premier health and safety watchdog in the United States, and throughout most of the world. Additionally, testing has shown Hygenall® HexOff™ to be over 99% effective, even in the microgram range!

Exposure to CrVI and other toxic metals have serious health risks

- **Chromium VI** – Respiratory distress, irritation of the nose lining, skin rashes – chrome ulcers, stomach ulcers, small intestine irritation, increased cancer in lung/stomach/intestine
- **Cadmium** – Chronic effects include anemia, rhinitis/anosmia, pulmonary emphysema, proteinuria and lung cancer. The primary target organs for chronic disease are the kidneys (non-carcinogenic) and the lungs (carcinogenic)
- **Lead** – Affects nervous system, increased blood pressure, anemia, brain function, kidney function, accumulates in body and is used as calcium, lowers IQ in children
- **Arsenic** – Increased cardiovascular disease, increased cancer risk, increased dermatitis, increased warts, and skin pigmentation
- **Other toxic metals include** – Zinc, Mercury, Silver, Magnesium, Aluminum, Uranium, Chromium, Arsenic, Nickel, Strontium, Vanadium, Zinc, Manganese, Barium, Beryllium, Aluminum and others. These are known as CAD ++ metals



Benefits of HexOff

- **HexOff Skin Guard Technology** leaves behind a natural layer of positively charged ions that help repel Hexavalent Chromium after use, akin to Scotch Guard for stains. No other soap can do this.
- While this product has been “tuned” to Hexavalent Chromium, it is effective on all CAD ++ metals including Lead, Mercury, Uranium, Selenium-72, Cadmium, Zinc, Arsenic, Silver, Beryllium and others.
- Hygenall HexOff products mimic soap, and it is an excellent degreaser, cleaning off heavy grease and grime. Hygenall HexOff No Rinse wipes and Surface Cleaner Spray contains ingredients to clean away germs, bacteria, and viruses (including H1N1).
- HexOff removes >99% of heavy metals down to 5,000 micrograms, the highest decontamination power in the world! Superior in effectiveness over Soap & Water, and regular cleaning wipes.
- Contains no EDTA, Phosphates, or other harmful chemicals. Low sudsing formula is safe for all wastewater systems.



Integrating HexOff into an EHS program

- Replace washroom soap dispensers with HexOff Foaming Soap dispensers.
- Place No Rinse Wipes or Decontamination Station in key locations where workers are removing PPE or where they are working with heavy metals.
- Replace conventional spray cleaners with Surface Cleaner Spray in break rooms, cafeterias, and other areas where workers gather.
- Place No Rinse Wipes in Tool Cribs and train workers to clean sanders, shrouds, and tools before returning them to storage.
- Incorporate HexOff products into general housekeeping practices, in compliance with OSHA standards.



HexOff No Rinse Wipes

Make No Rinse Wipes available to workers where they remove PPE after exposure to Hexavalent Chromium dust.

We recommend HexOff wipes to decontaminate sanders, shrouds, and other tools before returning them to the tool crib. Remember, the worker using the tool is protected from CrVI by his or her PPE, but the worker managing the tool crib is not - the hazardous dust can come back to the tool crib on every unwashed tool.

Removes Hexavalent Chromium, Cadmium, Lead, Nickel, Zinc, and other cationic metals from the skin. Cleans off dirt and helps remove viruses, bacteria, and germs.

HexOff No Rinse Wipes

Model	NSN	Desc	Price
415-NR045	4130-01-509-0270	HexOff No Rinse Wipes 45 Count Canister	
415-NR500	4130-01-459-4463	HexOff No Rinse Wipes 500 Count Tub	
415-NR500RF	4130-01-459-4448	HexOff No Rinse Wipes 500 Count Tub Refill	



HexOff Decon Station

Place this convenient standing station wherever your workers are removing PPE. Great for personnel cleanup outside of sanding booths, paint hangars, and in lockers. The stand holds No Rinse Wipes and a container to collect used wipes for disposal. 32in high tripod design won't wobble on uneven surfaces.

HexOff Decontamination Station

Model	NSN	Desc	Price
415-DS01		HexOff Decon Station with 500 No Rinse Wipes	
415-DS07	4130-01-509-0265	HexOff Decon Station Stand Only	
415-NR500RF	4130-01-459-4448	HexOff Decon Station 500 Count Refill	



HexOff Foaming Hand Wash

Replace conventional hand soap in washrooms and break rooms to provide workers with a safe and highly effective way to clean, disinfect, and remove CrVI from their hands and skin. Provides the same germ fighting strength of conventional hand soaps, but acts on a molecular level to release microscopic deposits of Hexavalent Chromium and other heavy metals from the skin.

HexOff Foaming Hand Wash

Model	NSN	Desc	Price
415-HW01		HexOff Foaming Hand Wash 1 Gal	
415-HW55		HexOff Foaming Hand Wash 55 Gal	
415-DS02		HexOff Foaming Hand Wash Refillable Dispenser	
415-DS08		HexOff Foaming Hand Wash 1 Gal Pump Dispenser	
415-DS04		HexOff 1 Gal Wall Mount	



Everyone uses the bathroom soap, so introducing HexOff here makes an immediate health impact on the entire organization

Replace washroom soap dispensers with HexOff Foaming Soap dispensers.

Our rich foam hand wash is ecologically friendlier than other liquid hand soaps and is delivered more uniformly, reducing overuse. It does not contain EDTA, Phosphates, or other harmful chemicals and its low sudsing formula is safe for all wastewater systems.

Leaves skin hydrated and feeling great!

Foaming Hand Wash 1 Gal

Refillable Dispenser

HexOff Surface Cleaner

Use this spray cleaner to clean and remove CrVI from work surfaces, equipment, floors and walls. Use on cafeteria tables and surfaces to remove CrVI that migrates in on workers hand and clothes. Contains environmentally safe ingredients that are low sudsing and phosphate free. Apply by hand, brush, or high pressure. Surface Guard Technology makes it difficult for CrVI and other heavy metals to stick to surfaces after use.

HexOff Surface Cleaner

Model	NSN	Desc	Price
415-SC01Q	4130-01-509-0271	HexOff Surface Cleaner 1Qt Spray Bottle	
415-SC05G		HexOff Surface Cleaner 5 Gal	
415-SC55G		HexOff Surface Cleaner 55 Gal	



HexOff Liquid Soap

Powerful hand soap that removes dirt, grime, heavy grease plus heavy metals. It is low sudsing, no EDTA or Phosphates. Made from natural environmentally friendly components and is wastewater friendly. Cationic surfactant with pH balancing keeps skin moisturized and clean. Highly effective hand-soap decontamination!

HexOff Liquid Soap

Model	NSN	Description	Price
415-LS01G		HexOff Liquid Soap 1 Gal	
415-LS55		HexOff Liquid Soap 55 Gal Drum	
415-DS03		HexOff Liquid Soap Refillable Dispenser	
415-DS04		HexOff Liquid Soap 1 Gal Wall Mount	
415-DS05		HexOff Liquid Soap 1 Gal Pump Dispenser	
415-DS06		HexOff Liquid Soap 55 Gal Pump Dispenser	



* Available on GSA Advantage website @ www.GSAadvantage.gov

BRAKE WASHERS

Mini • Economy • Deluxe • Truck



Clayton Aqueous Brake Washers & Parts Washers

The Clayton Brake Washer line is designed specifically for wetting and cleaning vehicle brakes during brake inspections and repair jobs. All Brake Washers are mobile and can be used to safely clean hazardous dust from all types of brakes, and then set aside to allow the brake work to continue.

- Aqueous brake washers are the OSHA preferred method for wetting and cleaning brakes
- Eliminates exposure to airborne brake dust during brake removal and cleaning of brakes
- Clean all four brakes on 30 cars for less than the cost of one can of aerosol brake cleaner
- 1 micron primary micro filters keeps our TNT cleaning solution going for approximately 150 vehicles
- Collects and recirculates TNT brake cleaning solution and keeps your shop floor clean
- Industrial construction stands up to the daily rigors and rough handling common to vehicle repair facilities

How Clayton Brake Washers Work

All Clayton brake washers use an industrial air powered re-circulating pump to flow our TNT cleaner over and thru brake pads, calipers, rotors, and drums. This OSHA preferred method wets and removes hazardous brake dust before it becomes airborne.

As the contaminated solution flows off the brakes it's caught by the brake washer basin and flows through one or more filters where the dust and debris are collected before the solution returns to the primary reservoir for recirculation. All Clayton Brake Washers utilize 1 micron primary filters to trap and contain brake dust and other contaminants.

TNT Solution

Clayton TNT cleaning solution is a patented formula of organic, biodegradable cleaners and rust inhibitor that quickly loosens and removes brake dust, dried oil, grease and dirt from the brakes. TNT is non-toxic, non-flammable, and safe for all brakes. One liter of this concentrated cleaner makes 15 gallons of brake cleaning solution that lasts for months.

Unlike most aerosol cleaners, TNT is safe for skin contact and produces no harmful fumes.

CareFree Disposal System

In most parts of the world, used TNT solution can be disposed of in the sanitary sewer. Filters can be disposed of as ordinary shop waste. Consult local authorities for information regarding disposal in your area.

Filtration

Clayton Brake Washers use a variety of filters and pre-filters to keep our TNT solution clean and effective for as long as possible. Drum style brake washers utilize a sock filter while bench top and truck styles use a flat filter of the same 1 micron media.

In addition to flow through filtration, we also use our Oil Magnet absorptive skimmer to collect and retain any oils, solvents, and coolants from the filtered TNT solution that may have been present on the brakes.

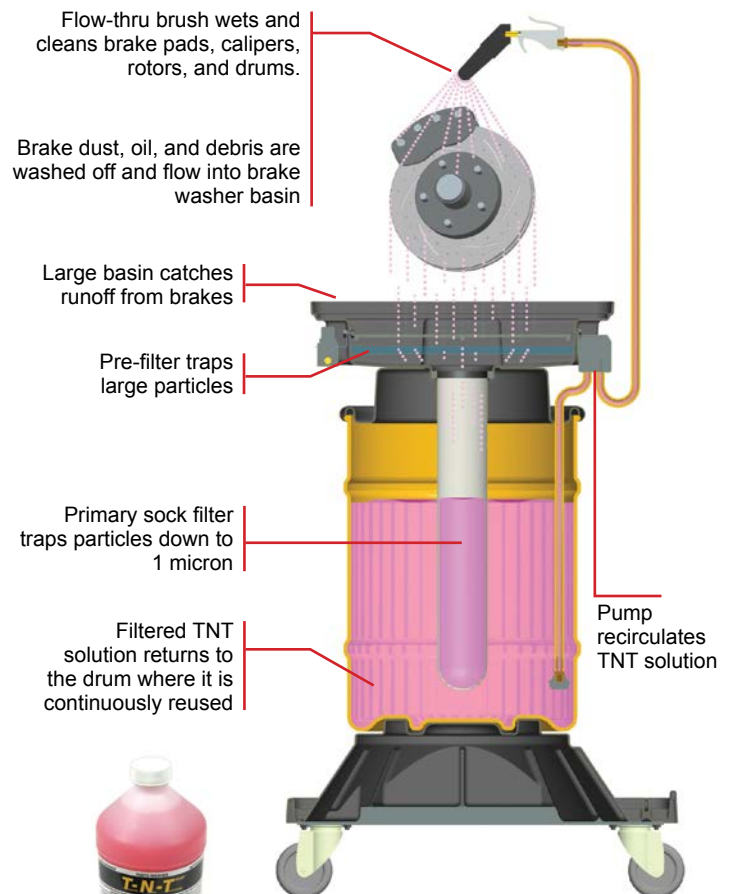

Side by Side Comparison



Mini
If you only do 1 brake job a day, then our mini air powered is all you need.



Economy
Discover the savings with our Economy portable brake washer for high volume shops.



Deluxe
Includes a drying gun, 2nd stage filter, and drain spigot for easy maintenance.



Truck
Low and large for truck brakes.

Part #	BCE-200	BCE-300	BCE-500	BCE-400
Dimensions	25w x 18d x 8h	28w x 20d x 32h	28w x 20d x 32h	36w x 27d x 11h
Tray Dimensions	20w x 16d x 7h	21w x 16d x 4-1/2h	26w x 20d x 7h	24w x 24d x 24h
Weight	20 lbs	52 lbs	55 lbs	73 lbs
Capacity	3.5 gal	15 gal	15 gal	6.5 gal
Flow Thru Brush	Yes	Yes	Yes	Yes
Drying Gun	No	No	Yes	Yes
Injector Gun	Yes	Yes	Yes	Yes
Faucet	No	No	No	No
Filtration	Single stage	2 stage	3 stage	2 stage
Power	32 psi	32 psi	32 psi	32 psi
Casters	N/A	4 in	4 in	4 in
Construction	Polyethylene	Polyethylene	Polyethylene	Polyethylene / Galvanized Steel
NSN	N/A	4940-01-396-0573	4940-01-396-0573	4940-01-421-8469

BCE-200 Mini Brake Washer

Big Features, small package.

Perfect for low volume shops, motorcycles, golf carts, and cars serviced on safety stands or ramp style lifts.

The BCE-200 Mini Brake Washer incorporates all the same components from our high volume drum style models but in a smaller package.

- Compressed air powered
- Flow-thru brush
- Injector nozzle
- All brass fittings
- Cover



- Polyethylene basin and cover will not rust, chip or dent

Model	Description	lbs	Price
BCE-200	Mini Brakewasher		
200-003-3	Primary Filter 3 pak		
400-001B	Oil Magnet		

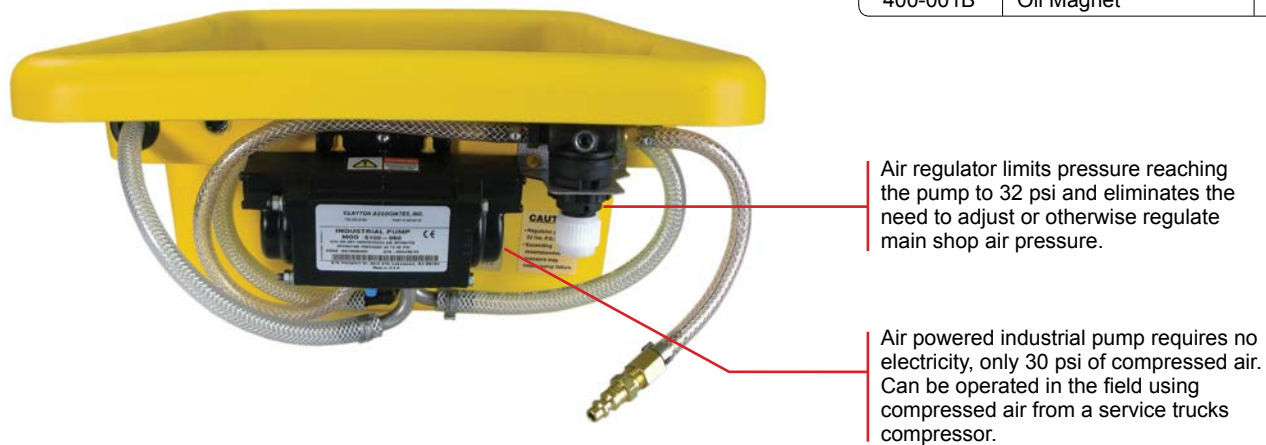

BCE-300 Economy Brake Washer

Outstanding performance in a no frills package, our economy drum style brake washer reduces your operating expenses at an entry level price.

- Drum style portable
- Compressed air powered
- Flow-thru brush
- Injector nozzle
- Cover

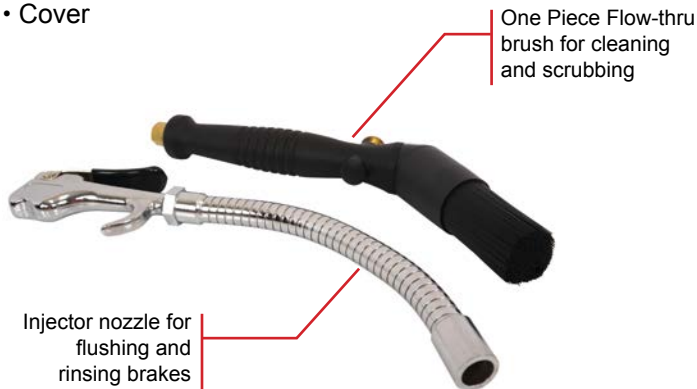

Model	Description	lbs	Price
BCE-300	Economy Brake Washer		
300-003-6	Primary Filter 6 pak		
300-006EA	Oil Magnet 1 pak		
300-036B	Splash Pad		

- Polyethylene basin, drum, and dolly will not rust, chip or dent
- Cover stores on dolly and doubles as a catch-basin when servicing vehicles on safety stands



BCE-500 Deluxe Brake Washer

Outstanding performance in a no frills package, our economy drum style brake washer reduces your operating expenses at an entry level price.

- Drum style portable
- Compressed air powered
- Flow-thru brush
- Injector nozzle
- Drying gun
- Cover



One Piece Flow-thru brush for cleaning and scrubbing

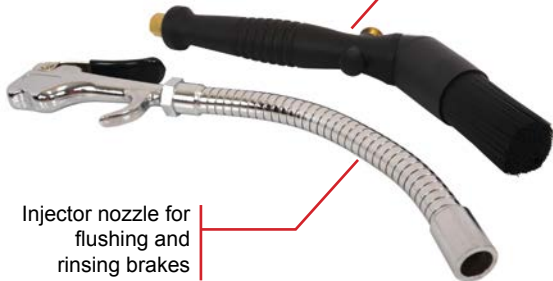

Injector nozzle for flushing and rinsing brakes

Large 10" cartridge filter

- Polyethylene basin and cover will not rust, chip or dent
- Cover stores on dolly and doubles as a catch-basin when servicing vehicles on safety stands

Model	Description	lbs	Price
BCE-500	Deluxe Brake Washer		
300-003-6	Primary Filter 6 pak		
300-006EA	Oil Magnet 1 pak		
300-038B	Splash Guard Pad		
500-039B	Ultra Filter Cartridge 10in		



Spigot for quick and easy draining when it's time to change the fluid



Compressed air drying gun

Large Basin 27 x 21 x 5

Removable flow-thru part tray with splash guard pad

Steel reinforced base



Large 5" locking casters make for easy movement and keep your brake washer stable on the shop floor



Cover stores on side of brake washer while in use

BCE-400 Truck Brake Washer

This large heavy duty brake washer is designed for commercial trucks, buses, tactical vehicles, and off highway equipment that is serviced on safety stands. Its low profile and folding handle allow it to creep into the limited space available in these situations.

- Low profile rolls under truck axels
- Compressed air powered
- Flow-thru brush
- Injector nozzle
- Drying gun
- All brass fittings
- Cover

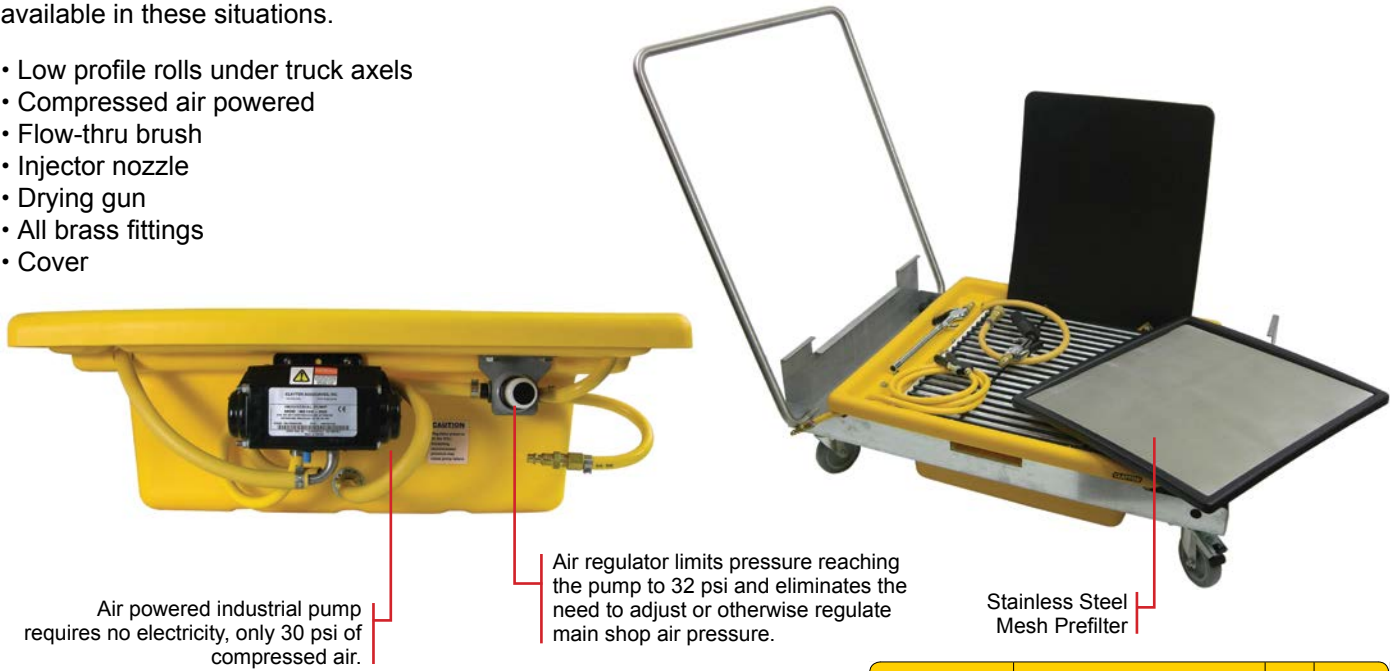

Air powered industrial pump requires no electricity, only 30 psi of compressed air.

Air regulator limits pressure reaching the pump to 32 psi and eliminates the need to adjust or otherwise regulate main shop air pressure.

Stainless Steel Mesh Prefilter

Model	Description	lbs	Price
BCE-400	Truck Brake Washer		
400-003-3	Primary Filter 3 pak		
400-001B	Oil Magnet 1 pak		
400-004	PreFilter		

- Polyethylene basin and cover will not rust, chip or dent

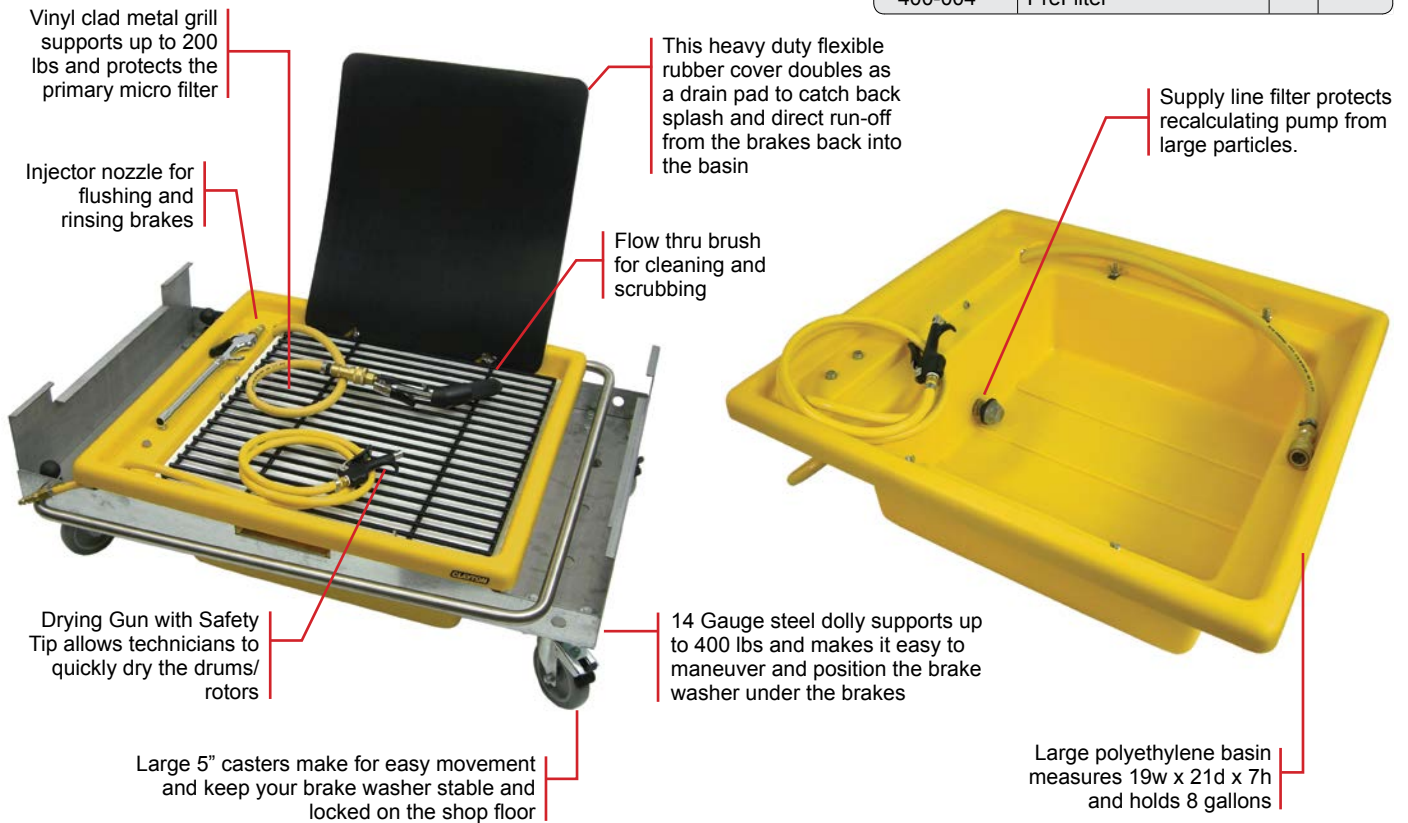

Vinyl clad metal grill supports up to 200 lbs and protects the primary micro filter

This heavy duty flexible rubber cover doubles as a drain pad to catch back splash and direct run-off from the brakes back into the basin

Supply line filter protects recirculating pump from large particles.

Injector nozzle for flushing and rinsing brakes

Flow thru brush for cleaning and scrubbing

Drying Gun with Safety Tip allows technicians to quickly dry the drums/rotors

14 Gauge steel dolly supports up to 400 lbs and makes it easy to maneuver and position the brake washer under the brakes

Large 5" casters make for easy movement and keep your brake washer stable and locked on the shop floor

Large polyethylene basin measures 19w x 21d x 7h and holds 8 gallons

MOBILE/PORTABLE TOOL STORAGE

Boxes • Carts • Mobile Work Centers • Pelican



Mobile / Portable Lockable Tactical Box

This heavy duty bin is rustproof, lockable and impervious to most chemicals, gas & oil. It's the US military's first choice for storage and transportation of dustless sanding & grinding equipment, hoses and abrasives.

- Large 6" wheels and recessed soft-grip side handles
- Wide telescopic steel handle with rubber grip
- Molded-in lockable metal latches and keyed center lock
- Heavy duty ribbed construction
- Resistant to chemicals, oils & gas
- Rustproof High Density Polyethylene withstands extreme temperatures
- 37"w x 23"d x 24"h x 30"lbs
- 50 gallon capacity
- Fits one 5 gallon Wart Hog HEPA vacuum, hoses, tools and accessories.



955-TB012
955-TB012NW

Mobile Storage Cart

Our Mobile Storage Cart is a great way to transport your dustless sanding equipment to and from work areas. Plenty of room for your vacuum system, hoses, and tools means fewer trips to the tool crib. Cart has a hanging bag with lid for contaminated abrasives, debris, or storage.

- High impact polypropylene construction
- Overall dimensions 46"L x 21"w x 38"h x 39 lbs
- Non marring 8" wheels and 4" casters
- 3 shelves 17 x 14 –1 shelf 18 x 18
- FOD / storage bag with lid
- Velcro strap to secure items
- Room for vacuum, hoses, and tools



955-TB005

Mobile Tool Storage

Model	NSN	Description	Price
955-TB012	^	Mobile Lockable Tactical Box	
955-TB012NW	^	Portable Lockable Tactical Box	
955-TB005		Mobile Storage Cart	

- ★ Available on GSA Advantage website @ www.GSAadvantage.gov
- ^ This item has an NSN - See Model / NSN table on page 4.



Rhino Mobile Work Center

Initially designed around the needs of aerospace composite repair and LO professionals, the Rhino is a robust mobile work center that can be outfitted to suit many fabrication and maintenance specialties.



The Rhino is available in 3 standard configurations or can be customized to meet your specific needs.

Locked and secured the Rhino is a compact mobile storage unit for tools and consumables.

- 8 large 6" casters support up to 2500 lbs
- Heavy duty tie down rings
- Integrated fork lift guides
- Closed dimensions 62w x 44d x 40h
- Open dimensions 124w x 28½d x 40h





Rhino Mobile Work Center (RH-500-01)

- Integrated electrical distribution
- Internal charging station for battery operated tools
- Storage for 50" spools of composite fabrics and films
- Exterior wings are removable to allow separate consumables storage
- Replaceable self-healing cutting surface
- Heavy duty 6" casters
- 6 tool drawers with shadowboxed two-color tool control foam
- Heavy duty tie-down rings
- Integrated forklift guides

Rhino Dustless Sanding Kit (RH-500-02)

- 1 x Rhino Mobile Work Center (RH-500-01)
- 2 x Hornet pneumatic HEPA vacs
- 2 x 3" ROS sanders
- 2 x 5" ROS sanders
- 2 x Air/Vac work hoses
- 2 x Compressed air lines 30'
- 3 x Cleanup tools

Rhino Composite Repair Kit (RH-500-03)

- 1 x Rhino Dustless Sanding Kit (RH-500-02)
- An extensive complement of composite & structural repair tools & equipment recommended by the USAF Advanced Composites Office



Internal charging station, power outlets, and shelves



Shadow boxed two color tool control foam

Rhino Mobile Work Centers

Model	NSN	Description	Weight lbs (kg)	Price
RH-500-01		Rhino Mobile Work Center	700 (317)	
RH-500-02		Rhino Dustless Sanding Kit	750 (340)	
RH-500-03		Rhino Composite Repair Kit	1000 (453)	

* Available on GSA Advantage website @ www.GSAadvantage.gov
 * This item has an NSN - See Model / NSN table on page 4.

TWIN TECH

MOBILE WORKCENTER



ONE SOURCE ZERO MESS

The Twin Tech Mobile WorkCenter is your complete mobile work station for industrial, automotive, marine, and aerospace sanding applications. It's designed for ultimate convenience and worker productivity and manufactured with military grade components to survive the toughest work environments. Easily organize your tools, supplies and accessories to maintain the highest quality standards while getting the job done on time, every time.

The Twin Tech Mobile WorkCenters are backed by a lifetime warranty against manufacturer defects. Proudly made in the USA.



ITEM NO	DESCRIPTION
955-TB5041	Twin Tech Mobile Work Center (5 Drawer)
955-TB5041-K02*	Twin Tech Mobile Work Center Kit (5 Drawer)
955-TB50-2	Additional Extended Work Surface
955-TB50-3	Additional Vacuum Base
955-TB50-8	Hose Hanger Assy

*** NSN - 5140-01-723-5610**

KIT CONTENTS	
WartHog 2-User Electric HEPA Vac	✓
(2) 6" Pneumatic DA Sanders	✓
(2) Air Vac Combo Hose 1" x 15'	✓
3" Round Vacuum Brush & 11" Crevice Tool	✓
7-Outlet Power Strip with Integrated Cord Wrap	✓
Drawer Storage Bins	✓
Pegboard Hook Sample Pack	✓
Shadow-Boxed Tool Control Foam	✓
Drawer Lock Bar	✓
6" 120G & 180G Abrasive Discs	✓

IT'S NOT JUST ANOTHER TOOL BOX!



2 TECHNICIANS WORK
SIDE BY SIDE

5 BI-DIRECTIONAL
DRAWERS

7 CUSTOMIZABLE
CONFIGURATIONS

FEATURES:

Dimensions 48L x 21W x 54H



DESIGNED FOR ULTIMATE CONVENIENCE

Removable Vacuum Base and Extended Work Surface Can Support Multiple Configurations

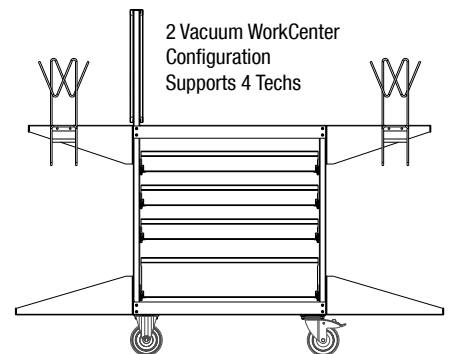
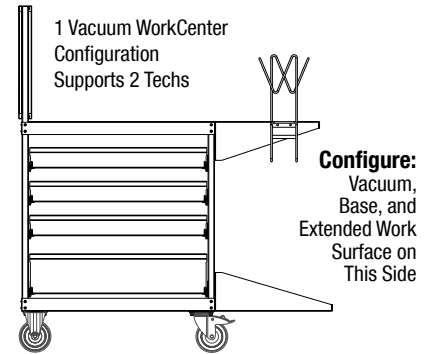
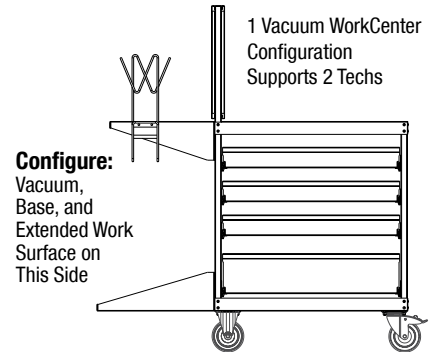

*Requires Purchase of Additional Extended Work Surface, Vacuum Base, Tool & Hose Hangers

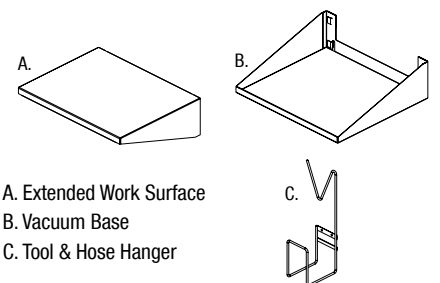

TWIN TECH

VACUUM MOUNTED WORKCENTER



TWO USERS, TWO ORGANIZED

The Twin Tech Vacuum Mounted WorkCenter (VMW) is your portable work solution for vacuum sanding and repairs. The innovative work platform mounts directly to compatible Clayton vacuums and offers time saving features that increase productivity, but don't increase the footprint of the equipment. The VMW is designed around the needs of aerospace and automotive sanding applications, and its versatility can benefit any industry. It is constructed with military grade components and stainless steel tubing to survive the toughest work environments. The double sided pegboard allows you to transport and organize supplies and accessories to maintain the highest quality standards while getting the job done on time, every time.

The Twin Tech VMW is backed by a lifetime warranty against manufacturer defects. Proudly made in the USA.

Mobile Tool Storage

Model	NSN	Description	Price
955-TB60-115		Mounted Vacuum Stand for 115 Poly Tank	

ELIMINATE THE MESS, TWO USERS AT A TIME.



2 SANDER & HOSE HANGERS

2 SIDED PEGBOARDS

2 WORK SURFACES

FEATURES

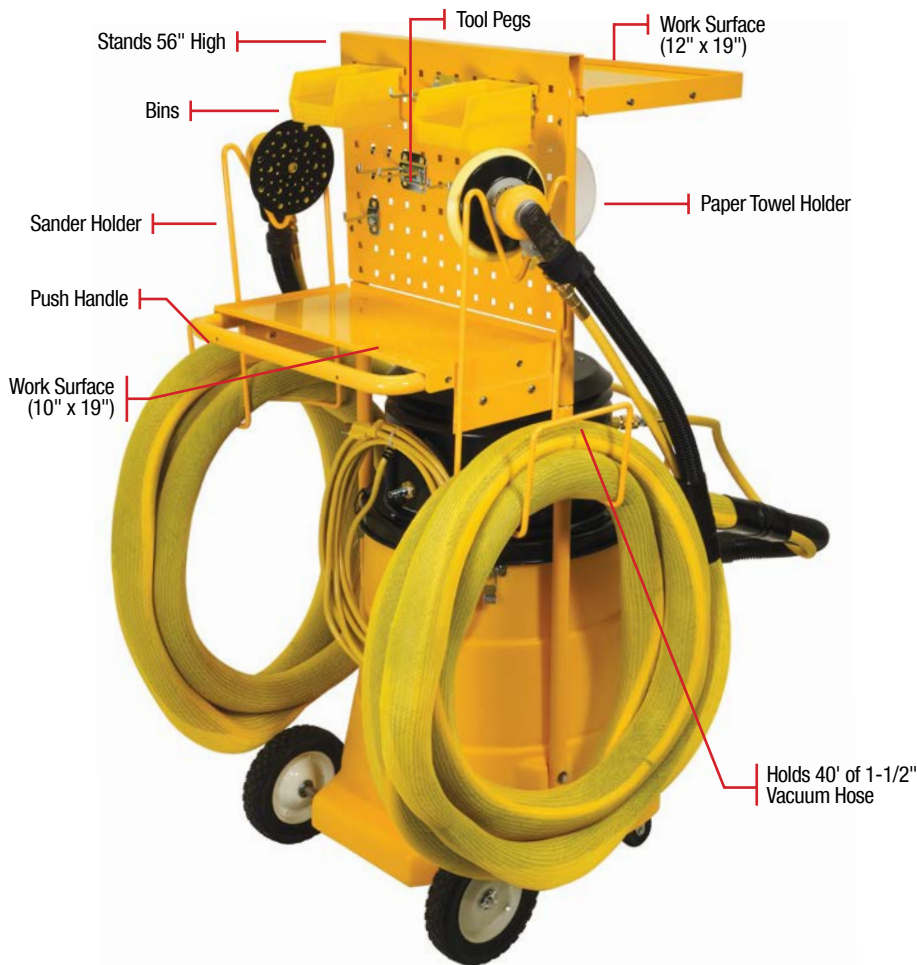

DESIGNED FOR WARTHOG VACUUMS

Add storage for sanders, hoses, tools, and more to any new or existing Clayton Warthog 15 gallon vacuum



Replaces The Handle On 15 Gallon Poly Warthog Tanks

Pegboard Accessories

- Paper Towel Holder
- Tool Pegs
- Bins

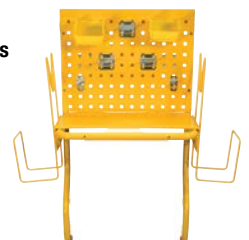

MEASUREMENTS AND CONVERSIONS

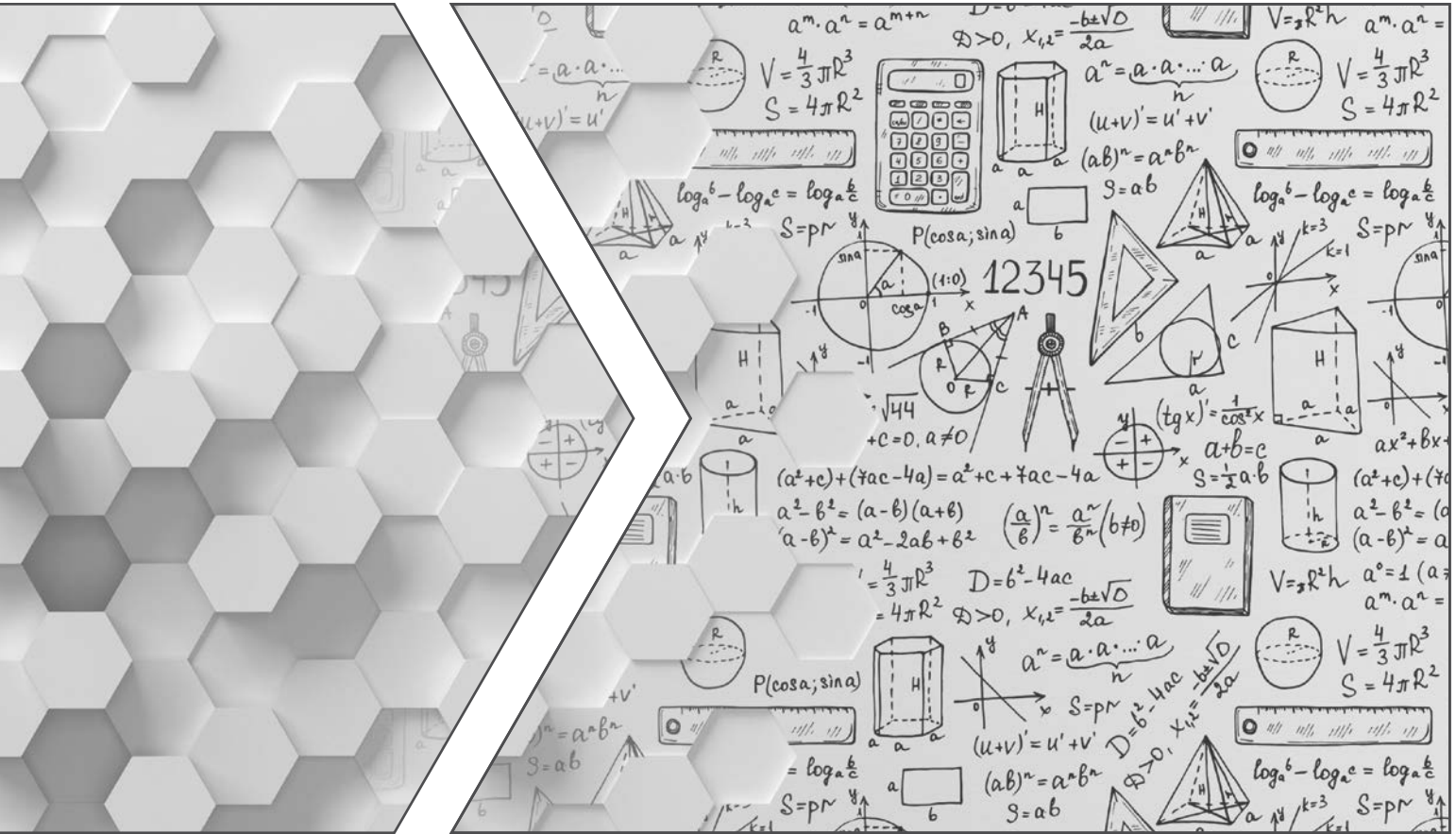

Pounds to kilograms

kg = lb x 2.204

lb = kg ÷ 2.204

Weight

Lbs	Kg	Lbs	Kg
0.1	0.05	5	2.27
0.2	0.09	5.1	2.31
0.3	0.14	5.2	2.36
0.4	0.18	5.3	2.40
0.5	0.23	5.4	2.45
0.6	0.27	5.5	2.49
0.7	0.32	5.6	2.54
0.8	0.36	5.7	2.59
0.9	0.41	5.8	2.63
1	0.45	5.9	2.68
1.1	0.50	6	2.72
1.2	0.54	6.1	2.77
1.3	0.59	6.2	2.81
1.4	0.64	6.3	2.86
1.5	0.68	6.4	2.90
1.6	0.73	6.5	2.95
1.7	0.77	6.6	2.99
1.8	0.82	6.7	3.04
1.9	0.86	6.8	3.08
2	0.91	6.9	3.13
2.1	0.95	7	3.18
2.2	1.00	7.1	3.22
2.3	1.04	7.2	3.27
2.4	1.09	7.3	3.31
2.5	1.13	7.4	3.36
2.6	1.18	7.5	3.40
2.7	1.22	7.6	3.45
2.8	1.27	7.7	3.49
2.9	1.32	7.8	3.54
3	1.36	7.9	3.58
3.1	1.41	8	3.63
3.2	1.45	8.1	3.67
3.3	1.50	8.2	3.72
3.4	1.54	8.3	3.76
3.5	1.59	8.4	3.81
3.6	1.63	8.5	3.86
3.7	1.68	8.6	3.90
3.8	1.72	8.7	3.95
3.9	1.77	8.8	3.99
4	1.81	8.9	4.04
4.1	1.86	9	4.08
4.2	1.91	9.1	4.13
4.3	1.95	9.2	4.17
4.4	2.00	9.3	4.22
4.5	2.04	9.4	4.26
4.6	2.09	9.5	4.31
4.7	2.13	9.6	4.35
4.8	2.18	9.7	4.40
4.9	2.22	9.8	4.45

Inches to millimeters

mm = in x 25.4

in = mm ÷ 25.4

Length

Inch	Inch	mm	Inch	Inch	mm
1/8	0.125	3.18	6-1/8	6.125	155.58
1/4	0.250	6.35	6-1/4	6.250	158.75
3/8	0.375	9.53	6-3/8	6.375	161.93
1/2	0.500	12.70	6-1/2	6.500	165.10
5/8	0.625	15.88	6-5/8	6.625	168.28
3/4	0.750	19.05	6-3/4	6.750	171.45
7/8	0.875	22.23	6-7/8	6.875	174.63
1	1.000	25.40	7	7.000	177.80
1-1/8	1.125	28.58	7-1/8	7.125	180.98
1-1/4	1.250	31.75	7-1/4	7.250	184.15
1-3/8	1.375	34.93	7-3/8	7.375	187.33
1-1/2	1.500	38.10	7-1/2	7.500	190.50
1-5/8	1.625	41.28	7-5/8	7.625	193.68
1-3/4	1.750	44.45	7-3/4	7.750	196.85
1-7/8	1.875	47.63	7-7/8	7.875	200.03
2	2.000	50.80	8	8.000	203.20
2-1/8	2.125	53.98	8-1/8	8.125	206.38
2-1/4	2.250	57.15	8-1/4	8.250	209.55
2-3/8	2.375	60.33	8-3/8	8.375	212.73
2-1/2	2.500	63.50	8-1/2	8.500	215.90
2-5/8	2.625	66.68	8-5/8	8.625	219.08
2-3/4	2.750	69.85	8-3/4	8.750	222.25
2-7/8	2.875	73.03	8-7/8	8.875	225.43
3	3.000	76.20	9	9.000	228.60
3-1/8	3.125	79.38	9-1/8	9.125	231.78
3-1/4	3.250	82.55	9-1/4	9.250	234.95
3-3/8	3.375	85.73	9-3/8	9.375	238.13
3-1/2	3.500	88.90	9-1/2	9.500	241.30
3-5/8	3.625	92.08	9-5/8	9.625	244.48
3-3/4	3.750	95.25	9-3/4	9.750	247.65
3-7/8	3.875	98.43	9-7/8	9.875	250.83
4	4.000	101.60	10	10.000	254.00
4-1/8	4.125	104.78	10-1/8	10.125	257.18
4-1/4	4.250	107.95	10-1/4	10.250	260.35
4-3/8	4.375	111.13	10-3/8	10.375	263.53
4-1/2	4.500	114.30	10-1/2	10.500	266.70
4-5/8	4.625	117.48	10-5/8	10.625	269.88
4-3/4	4.750	120.65	10-3/4	10.750	273.05
4-7/8	4.875	123.83	10-7/8	10.875	276.23
5	5.000	127.00	11	11.000	279.40
5-1/8	5.125	130.18	11-1/8	11.125	282.58
5-1/4	5.250	133.35	11-1/4	11.250	285.75
5-3/8	5.375	136.53	11-3/8	11.375	288.93
5-1/2	5.500	139.70	11-1/2	11.500	292.10
5-5/8	5.625	142.88	11-5/8	11.625	295.28
5-3/4	5.750	146.05	11-3/4	11.750	298.45
5-7/8	5.875	149.23	11-7/8	11.875	301.63
6	6.000	152.40	12	12.000	304.80

Vacuum

Inches of Water Column to Inches of Mercury

"H2O = "Hg x 13.57

"Hg = "H2O ÷ 13.57

Vacuum

"H2O	"Hg	"Hg	"H2O
10	0.74	1.00	13.6
15	1.10	1.25	17.0
20	1.47	1.50	20.4
25	1.84	1.75	23.8
30	2.21	2.00	27.2
35	2.57	2.25	30.6
40	2.94	2.50	34.0
45	3.31	2.75	37.4
50	3.68	3.00	40.8
55	4.05	3.25	44.2
60	4.41	3.50	47.6
65	4.78	3.75	51.0
70	5.15	4.00	54.4
75	5.52	4.25	57.8
80	5.88	4.50	61.2
85	6.25	4.75	64.6
90	6.62	5.00	68.0
95	6.99	5.25	71.4
100	7.36	5.50	74.8
105	7.72	5.75	78.2
110	8.09	6.00	81.6
115	8.46	6.25	85.0
120	8.83	6.50	88.4
125	9.19	6.75	91.8
130	9.56	7.00	95.2
135	9.93	7.25	98.6
140	10.30	7.50	102.0
145	10.66	7.75	105.4
150	11.03	8.00	108.8
155	11.40	8.25	112.2
160	11.77	8.50	115.6
165	12.14	8.75	119.0
170	12.50	9.00	122.4
175	12.87	9.25	125.8
180	13.24	9.50	129.2
185	13.61	9.75	132.6
190	13.97	10.00	136.0
195	14.34	10.25	139.4
200	14.71	10.50	142.8
205	15.08	10.75	146.2
210	15.45	11.00	149.6
215	15.81	11.25	153.0
220	16.18	11.50	156.4
225	16.55	11.75	159.8
230	16.92	12.00	163.2
235	17.28	12.25	166.6
240	17.65	12.50	170.0
245	18.02	12.75	173.4

Power

Horse Power to Watts

HP = W x 745.7

W = HP ÷ 745.7

Power

HP	Watts
0.10	75
0.20	149
0.30	224
0.40	298
0.50	373
0.60	447
0.70	522
0.80	597
0.90	671
1.00	746
1.10	820
1.20	895
1.30	969
1.40	1,044
1.50	1,119
1.60	1,193
1.70	1,268
1.80	1,342
1.90	1,417
2.00	1,491
2.10	1,566
2.20	1,641
2.30	1,715
2.40	1,790
2.50	1,864
2.60	1,939
2.70	2,013
2.80	2,088
2.90	2,163
3.00	2,237
3.10	2,312
3.20	2,386
3.30	2,461
3.40	2,535
3.50	2,610
3.60	2,685
3.70	2,759
3.80	2,834
3.90	2,908
4.00	2,983
4.10	3,057
4.20	3,132
4.30	3,207
4.40	3,281
4.50	3,356
4.60	3,430
4.70	3,505
4.80	3,579

Flow

Cubic Feet / Minute to Liters / Minute

CFM = LPM x 28.32

LPM = CFM ÷ 28.32

Flow

CFM	LPM
1.00	28
6.00	170
11.00	312
16.00	453
21.00	595
26.00	736
31.00	878
36.00	1,020
41.00	1,161
46.00	1,303
51.00	1,444
56.00	1,586
61.00	1,728
66.00	1,869
71.00	2,011
76.00	2,152
81.00	2,294
86.00	2,436
91.00	2,577
96.00	2,719
101.00	2,860
106.00	3,002
111.00	3,144
116.00	3,285
121.00	3,427
126.00	3,568
131.00	3,710
136.00	3,852
141.00	3,993
146.00	4,135
151.00	4,276
156.00	4,418
161.00	4,560
166.00	4,701
171.00	4,843
176.00	4,984
181.00	5,126
186.00	5,268
191.00	5,409
196.00	5,551
201.00	5,692
206.00	5,834
211.00	5,976
216.00	6,117
221.00	6,259
226.00	6,400
231.00	6,542
236.00	6,684

Rotational Velocity to Tangential Velocity

Feet/Minute = RPM x π x Diameter ÷ 12

Miles/Hour = (RPM x π x Diameter ÷ 12 x 60) ÷ 5280

1" Disc			2" Disc			3" Disc			5" Disc			7" Disc		
RPM	FPM	MPH	RPM	FPM	MPH	RPM	FPM	MPH	RPM	FPM	MPH	RPM	FPM	MPH
500	131	1	500	262	3	500	393	4	500	654	7	500	916	10
1,000	262	3	1,000	524	6	1,000	785	9	1,000	1,309	15	1,000	1,833	21
1,500	393	4	1,500	785	9	1,500	1,178	13	1,500	1,963	22	1,500	2,749	31
2,000	524	6	2,000	1,047	12	2,000	1,571	18	2,000	2,618	30	2,000	3,665	42
2,500	654	7	2,500	1,309	15	2,500	1,963	22	2,500	3,272	37	2,500	4,581	52
3,000	785	9	3,000	1,571	18	3,000	2,356	27	3,000	3,927	45	3,000	5,498	62
3,500	916	10	3,500	1,833	21	3,500	2,749	31	3,500	4,581	52	3,500	6,414	73
4,000	1,047	12	4,000	2,094	24	4,000	3,142	36	4,000	5,236	59	4,000	7,330	83
4,500	1,178	13	4,500	2,356	27	4,500	3,534	40	4,500	5,890	67	4,500	8,246	94
5,000	1,309	15	5,000	2,618	30	5,000	3,927	45	5,000	6,545	74	5,000	9,163	104
5,500	1,440	16	5,500	2,880	33	5,500	4,320	49	5,500	7,199	82	5,500	10,079	115
6,000	1,571	18	6,000	3,142	36	6,000	4,712	54	6,000	7,854	89	6,000	10,995	125
6,500	1,702	19	6,500	3,403	39	6,500	5,105	58	6,500	8,508	97	6,500	11,912	135
7,000	1,833	21	7,000	3,665	42	7,000	5,498	62	7,000	9,163	104	7,000	12,828	146
7,500	1,963	22	7,500	3,927	45	7,500	5,890	67	7,500	9,817	112	7,500	13,744	156
8,000	2,094	24	8,000	4,189	48	8,000	6,283	71	8,000	10,472	119	8,000	14,660	167
8,500	2,225	25	8,500	4,450	51	8,500	6,676	76	8,500	11,126	126	8,500	15,577	177
9,000	2,356	27	9,000	4,712	54	9,000	7,068	80	9,000	11,781	134	9,000	16,493	187
9,500	2,487	28	9,500	4,974	57	9,500	7,461	85	9,500	12,435	141	9,500	17,409	198
10,000	2,618	30	10,000	5,236	59	10,000	7,854	89	10,000	13,090	149	10,000	18,325	208
10,500	2,749	31	10,500	5,498	62	10,500	8,246	94	10,500	13,744	156	10,500	19,242	219
11,000	2,880	33	11,000	5,759	65	11,000	8,639	98	11,000	14,399	164	11,000	20,158	229
11,500	3,011	34	11,500	6,021	68	11,500	9,032	103	11,500	15,053	171	11,500	21,074	239
12,000	3,142	36	12,000	6,283	71	12,000	9,425	107	12,000	15,708	178	12,000	21,991	250
12,500	3,272	37	12,500	6,545	74	12,500	9,817	112						
13,000	3,403	39	13,000	6,807	77	13,000	10,210	116						
13,500	3,534	40	13,500	7,068	80	13,500	10,603	120						
14,000	3,665	42	14,000	7,330	83	14,000	10,995	125						
14,500	3,796	43	14,500	7,592	86	14,500	11,388	129						
15,000	3,927	45	15,000	7,854	89	15,000	11,781	134						
15,500	4,058	46	15,500	8,116	92	15,500	12,173	138						
16,000	4,189	48	16,000	8,377	95	16,000	12,566	143						
16,500	4,320	49	16,500	8,639	98	16,500	12,959	147						
17,000	4,450	51	17,000	8,901	101	17,000	13,351	152						
17,500	4,581	52	17,500	9,163	104	17,500	13,744	156						
18,000	4,712	54	18,000	9,425	107	18,000	14,137	161						
18,500	4,843	55	18,500	9,686	110	18,500	14,529	165						
19,000	4,974	57	19,000	9,948	113	19,000	14,922	170						
19,500	5,105	58	19,500	10,210	116	19,500	15,315	174						
20,000	5,236	59	20,000	10,472	119	20,000	15,708	178						
20,500	5,367	61	20,500	10,733	122	20,500	16,100	183						
21,000	5,498	62	21,000	10,995	125	21,000	16,493	187						
21,500	5,629	64	21,500	11,257	128	21,500	16,886	192						
22,000	5,759	65	22,000	11,519	131	22,000	17,278	196						
22,500	5,890	67	22,500	11,781	134	22,500	17,671	201						
23,000	6,021	68	23,000	12,042	137	23,000	18,064	205						
23,500	6,152	70	23,500	12,304	140	23,500	18,456	210						
24,000	6,283	71	24,000	12,566	143	24,000	18,849	214						
24,500	6,414	73	24,500	12,828	146	24,500	19,242	219						
25,000	6,545	74	25,000	13,090	149	25,000	19,634	223						
25,500	6,676	76	25,500	13,351	152	25,500	20,027	228						
6" Disc			8" Disc											
RPM	FPM	MPH	RPM	FPM	MPH									
500	785	9	500	1,047	12									
1,000	1,571	18	1,000	2,094	24									
1,500	2,356	27	1,500	3,142	36									
2,000	3,142	36	2,000	4,189	48									
2,500	3,927	45	2,500	5,236	59									
3,000	4,712	54	3,000	6,283	71									
3,500	5,498	62	3,500	7,330	83									
4,000	6,283	71	4,000	8,377	95									
4,500	7,068	80	4,500	9,425	107									
5,000	7,854	89	5,000	10,472	119									
5,500	8,639	98	5,500	11,519	131									
6,000	9,425	107	6,000	12,566	143									
6,500	10,210	116	6,500	13,613	155									
7,000	10,995	125	7,000	14,660	167									
7,500	11,781	134	7,500	15,708	178									
8,000	12,566	143	8,000	16,755	190									
8,500	13,351	152	8,500	17,802	202									
9,000	14,137	161	9,000	18,849	214									
9,500	14,922	170	9,500	19,896	226									
10,000	15,708	178	10,000	20,943	238									
10,500	16,493	187	10,500	21,991	250									
11,000	17,278	196	11,000	23,038	262									
11,500	18,064	205	11,500	24,085	274									
12,000	18,849	214	12,000	25,132	286									

Pressure**Pounds/SqIn (PSI) to Kilopascals (kPa) to bar**

kPa = PSI x 6.89 bar = PSI x 0.0689

Pressure

PSI	kPa	bar
1	6.89	0.07
4	27.58	0.28
7	48.26	0.48
10	68.94	0.69
13	89.62	0.90
16	110.30	1.10
19	130.99	1.31
22	151.67	1.52
25	172.35	1.72
28	193.03	1.93
31	213.71	2.14
34	234.40	2.34
37	255.08	2.55
40	275.76	2.76
43	296.44	2.96
46	317.12	3.17
49	337.81	3.38
52	358.49	3.58
55	379.17	3.79
58	399.85	4.00
61	420.53	4.21
64	441.22	4.41
67	461.90	4.62
70	482.58	4.83
73	503.26	5.03
76	523.94	5.24
79	544.63	5.45
82	565.31	5.65
85	585.99	5.86
88	606.67	6.07
91	627.35	6.27
94	648.04	6.48
97	668.72	6.69
100	689.40	6.89
103	710.08	7.10
106	730.76	7.31
109	751.45	7.51
112	772.13	7.72
115	792.81	7.93
118	813.49	8.13
121	834.17	8.34
124	854.86	8.55
127	875.54	8.76
130	896.22	8.96
133	916.90	9.17
136	937.58	9.38
139	958.27	9.58
142	978.95	9.79
145	999.63	10.00
148	1,020.31	10.20
151	1,040.99	10.41

Sound Decibels

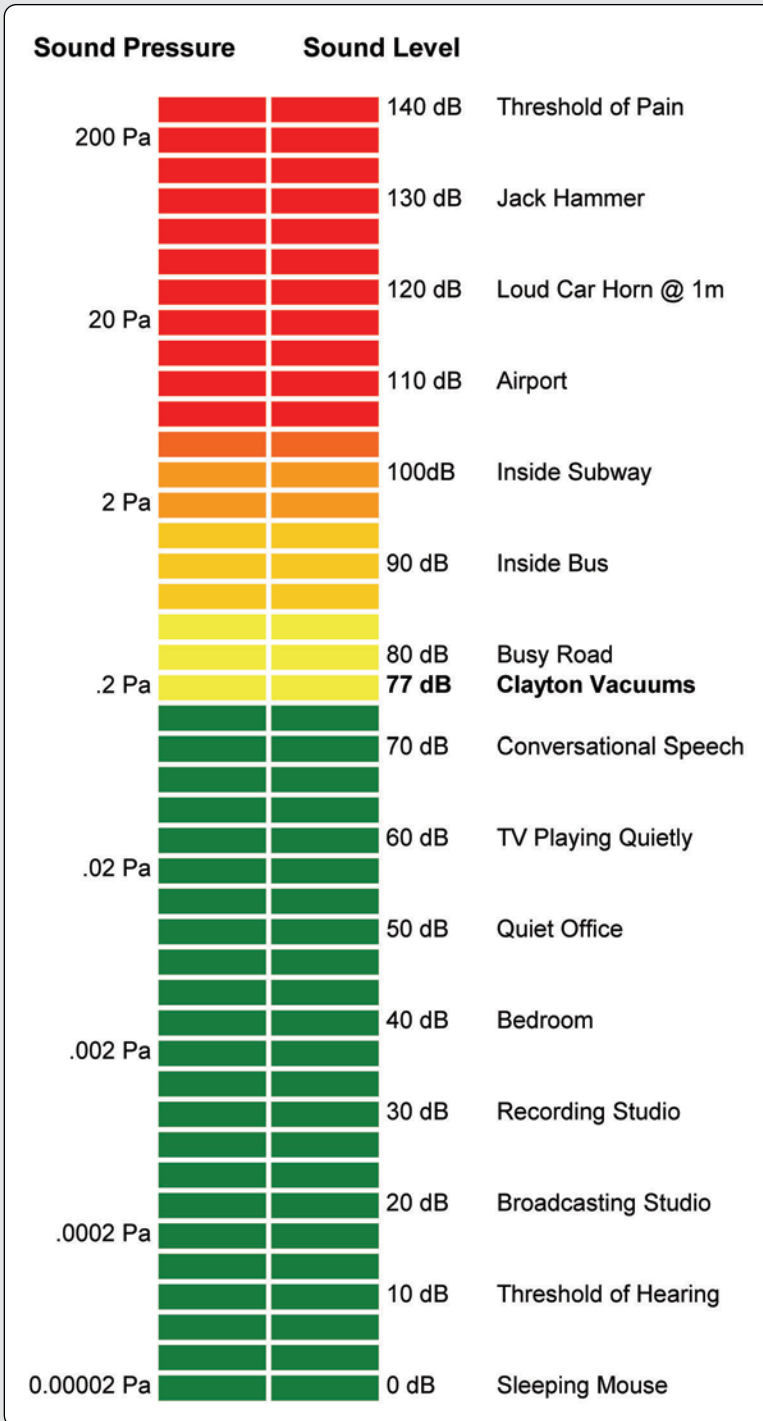

Noise Exposure Limits

OSHA Occupational Noise Exposure. - 1910.95

Permissible Noise Exposure

Hours / Day	dBA
8.00	90
6.00	92
4.00	95
3.00	97
2.00	100
1.50	102
1.00	105
0.50	110
0.25	115

Occupational Exposure to Hexavalent Chromium

Chromium hexavalent (CrVI) compounds, often called hexavalent chromium, exist in several forms. Industrial uses of hexavalent chromium compounds include chromate pigments in dyes, paints, inks, and plastics; chromates added as anticorrosive agents to paints, primers, and other surface coatings; and chromic acid electroplated onto metal parts to provide a decorative or protective coating. Hexavalent chromium can also be formed when performing "hot work" such as welding on stainless steel or melting chromium metal. In these situations the chromium is not originally hexavalent, but the high temperatures involved in the process result in oxidation that converts the chromium to a hexavalent state.

On February 28, 2006, OSHA promulgated a revised Hexavalent chromium standard for general industry that includes a permissible exposure limit ("PEL") for Hexavalent chromium of 5 micrograms per cubic meter ("µg/m3") measured as an 8-hour time weighted average ("TWA"), and a deadline of May 31, 2010, for employers to come into compliance with this PEL through the implementation of engineering controls.

The Action Level is set at one-half of the PEL, or 2.5 micrograms per cubic meter of air calculated as an 8- hour time-weighted average ("TWA")



CLAYTON
Dustless Made Simple™

Clayton Associates, Inc.
1650 Oak St. • Lakewood, NJ 08701
P. 732.363.2100 • F. 732.364.6084
800.248.8650 • Sales@JClayton.com

www.DustlessMadeSimple.com
www.VacuumSanding.com