

MILITARY KITS FOR EVERY PART OF THE JOB

Shop with NSNs, GSA or Credit Card

Scan to download the
App or PDF



See Page 15 for
Ordering Instructions



JANUARY
2026



SECTION 1

NSN & GSA

TWIN TECH MOBILE WORKCENTER

The Twin Tech Mobile WorkCenter is your complete mobile work station for industrial, automotive, marine, and aerospace sanding applications. **Proudly made in the USA.**

• Warthog 2-User Electric HEPA Vac

- (2) 6" Pneumatic DA Sanders
- (2) Air Vac Combo Hose 1" x 15'
- 3" Round Vacuum Brush & 11" Crevice Tool
- 7-Outlet Power Strip with Integrated Cord Wrap
- Drawer Storage Bins
- Pegboard Hook Sample Pack
- Shadow-Boxed Tool Control Foam
- Drawer Lock Bar
- 6" 120G & 180G Abrasive Discs

Twin Tech			
Item No	GSA	NSN	Desc
955-TB5041-K02		5140-01-723-5610	Twin Tech Mobile Work Center

FEATURES:

Dimensions 48L x 22W x 54H



IT'S NOT JUST ANOTHER TOOL BOX!

2 TECHNICIANS WORK
SIDE BY SIDE

5 BI-DIRECTIONAL
DRAWERS

7 CUSTOMIZABLE
CONFIGURATIONS



Mobile Storage

This heavy duty tote is rain tight, rustproof, lockable and impervious to most chemicals, gas & oil. It's the US military's first choice for storage and transportation of dustless sanding & grinding equipment, hoses and abrasives.

- Large 6" wheels and recessed soft-grip side handles
- Wide telescopic steel handle with rubber grip
- Molded-in lockable metal latches and keyed center lock
- Heavy duty ribbed construction
- Resistant to chemicals, oils & gas
- Rustproof high density polyethylene withstands extreme temperatures
- 37" w x 23" d x 24" h x 30" lbs
- 50 gallon capacity
- Fits one 5 gallon Wart Hog HEPA vacuum, hoses, tools and accessories



Mobile Tool Crib			
Item No	GSA	NSN	Desc
955-TB012		4130-01-482-5062	Mobile Storage Tote

The Posi-Vac insulated job box can be used to store resin, adhesives, paints, or anything that needs to be kept cold. This beast of a cooler will keep ice frozen for days in normal environments, and even longer for you troops stationed in Alaska. Tough wheels and a flip up handle let you easily move this bad boy, even when it's packed with ice and supplies, and the molded handles make it easy to lift into your vehicle. Unit includes pressure relief valve, padlock, cargo net, and a bluetooth temperature sensor to actively monitor internal temperatures. Roll one into your shop today!

Cooler			
Item No	GSA	NSN	Desc
955-CL001	★		Clayton Tactical Cooler with Accessories

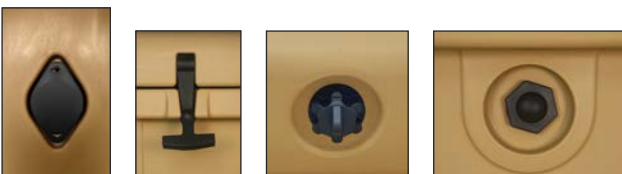

Bluetooth Temp Sensor Latch Drain Valve Pressure Relief Valve



Padlock

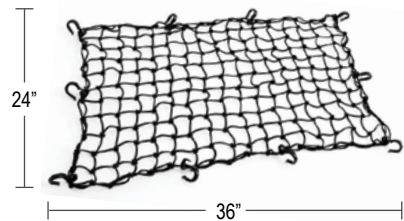

Clip-On Cargo Net

Disc & Sheet Abrasive

Screen Abrasives provide the best possible dust extraction, with no holes to line up. These aluminum oxide abrasives feature a hook and loop backing, with no adhesives to dry out or fail.

3in Screen Abrasive			
Item No	GSA	NSN	Desc
830-DMS080HV	★	5345-01-521-5652	3in 080 grit Screen Hook & Loop 250pk
830-DMS100HV	★		3in 100 grit Screen Hook & Loop 250pk
830-DMS120HV	★	5345-01-528-9897	3in 120 grit Screen Hook & Loop 250pk
830-DMS150HV	★		3in 150 grit Screen Hook & Loop 250pk
830-DMS180HV	★	5345-01-521-4927	3in 180 grit Screen Hook & Loop 250pk
830-DMS220HV	★		3in 220 grit Screen Hook & Loop 250pk
830-DMS240HV	★	5345-01-521-4926	3in 240 grit Screen Hook & Loop 250pk
830-DMS320HV	★	5345-01-521-6602	3in 320 grit Screen Hook & Loop 250pk
830-DMS400HV	★		3in 400 grit Screen Hook & Loop 250pk

★ Available on GSA Advantage Website @ www.GSAadvantage.gov

5in Screen Abrasive			
Item No	GSA	NSN	Desc
850-DMS080HV	★		5in 080 grit Screen Hook & Loop 250pk
850-DMS100HV	★		5in 100 grit Screen Hook & Loop 250pk
850-DMS120HV	★		5in 120 grit Screen Hook & Loop 250pk
850-DMS150HV	★		5in 150 grit Screen Hook & Loop 250pk
850-DMS180HV	★		5in 180 grit Screen Hook & Loop 250pk
850-DMS220HV	★		5in 220 grit Screen Hook & Loop 250pk
850-DMS240HV	★		5in 240 grit Screen Hook & Loop 250pk
850-DMS320HV	★		5in 320 grit Screen Hook & Loop 250pk
850-DMS400HV	★		5in 400 grit Screen Hook & Loop 250pk

★ Available on GSA Advantage Website @ www.GSAadvantage.gov

6in Screen Abrasive			
Item No	GSA	NSN	Desc
860-DMS080HV	★	5345-01-521-4185	6in 080 grit Screen Hook & Loop 250pk
860-DMS100HV	★		6in 100 grit Screen Hook & Loop 250pk
860-DMS120HV	★	5345-01-521-4542	6in 120 grit Screen Hook & Loop 250pk
860-DMS150HV	★		6in 150 grit Screen Hook & Loop 250pk
860-DMS180HV	★	5345-01-521-7251	6in 180 grit Screen Hook & Loop 250pk
860-DMS220HV	★		6in 220 grit Screen Hook & Loop 250pk
860-DMS240HV	★	5345-01-521-4548	6in 240 grit Screen Hook & Loop 250pk
860-DMS320HV	★	5345-01-521-4541	6in 320 grit Screen Hook & Loop 250pk
860-DMS400HV	★		6in 400 grit Screen Hook & Loop 250pk

★ Available on GSA Advantage Website @ www.GSAadvantage.gov

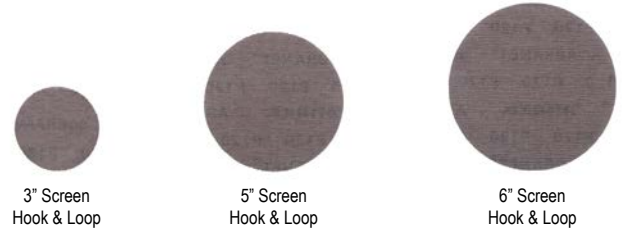

3x4in Screen Abrasive			
Item No	GSA	NSN	Desc
834-DMS120HV		5345-01-521-5653	3x4in 120 grit Screen Hook & Loop 250pk
834-DMS180HV		5345-01-521-4186	3x4in 180 grit Screen Hook & Loop 250pk
834-DMS240HV		5345-01-521-4536	3x4in 240 grit Screen Hook & Loop 250pk
834-DMS320HV		5345-01-521-4537	3x4in 320 grit Screen Hook & Loop 250pk



3-2/3x7in Screen Abrasive			
Item No	GSA	NSN	Desc
837-DMS120HV		5345-01-521-4933	3-2/3x7in 120 grit Screen Hook & Loop 250pk
837-DMS180HV		5345-01-521-4540	3-2/3x7in 180 grit Screen Hook & Loop 250pk
837-DMS240HV		5345-01-533-0175	3-2/3x7in 240 grit Screen Hook & Loop 250pk
837-DMS320HV		5345-01-521-4929	3-2/3x7in 320 grit Screen Hook & Loop 250pk

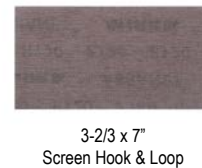

Quick Change Discs 1in

Postiv-Lok quick change discs provide great dust extraction when used with Clayton shrouded grinders. The tough aluminum oxide grain makes short work of coatings and corrosion.

Quick Change - 1in TR			
Item No	GSA	NSN	Desc
800-16M003	★		1in Coarse Quick Change Discs TR Style 250 pk
800-16M006	★		1in Medium Quick Change Discs TR Style 250 pk
800-16M009	★		1in Very Fine Quick Change Discs TR Style 250 pk
800-16M036	★		1in 36 grit Quick Change Discs TR Style 250 pk
800-16M060	★		1in 60 grit Quick Change Discs TR Style 250 pk
800-16M080	★		1in 80 grit Quick Change Discs TR Style 250 pk
800-16M100	★		1in 100 grit Quick Change Discs TR Style 250 pk
800-16M120	★		1in 120 grit Quick Change Discs TR Style 250 pk
800-16M150	★		1in 150 grit Quick Change Discs TR Style 250 pk
800-16M180	★		1in 180 grit Quick Change Discs TR Style 250 pk
800-16M240	★		1in 240 grit Quick Change Discs TR Style 250 pk
800-16M320	★		1in 320 grit Quick Change Discs TR Style 250 pk

★ Available on GSA Advantage Website @ www.GSAadvantage.gov

Quick Change - 1in TS			
Item No	GSA	NSN	Desc
800-16F003	★		1in Coarse Quick Change Discs TS Style 250 pk
800-16F006	★		1in Medium Quick Change Discs TS Style 250 pk
800-16F009	★		1in Very Fine Quick Change Discs TS Style 250 pk
800-16F036	★		1in 36 grit Quick Change Discs TS Style 250 pk
800-16F060	★		1in 60 grit Quick Change Discs TS Style 250 pk
800-16F080	★		1in 80 grit Quick Change Discs TS Style 250 pk
800-16F100	★		1in 100 grit Quick Change Discs TS Style 250 pk
800-16F120	★		1in 120 grit Quick Change Discs TS Style 250 pk
800-16F150	★		1in 150 grit Quick Change Discs TS Style 250 pk
800-16F180	★		1in 180 grit Quick Change Discs TS Style 250 pk </td
800-16F240	★		1in 240 grit Quick Change Discs TS Style 250 pk
800-16F320	★		1in 320 grit Quick Change Discs TS Style 250 pk

★ Available on GSA Advantage Website @ www.GSAadvantage.gov

Quick Change - 1in TP			
Item No	GSA	NSN	Desc
800-16TP003	★		1in Coarse Quick Change Discs TP Style 100 pk
800-16TP006	★		1in Medium Quick Change Discs TP Style 100 pk
800-16TP009	★		1in Very Fine Quick Change Discs TP Style 100 pk
800-16TP036	★		1in 36 grit Quick Change Discs TP Style 100 pk
800-16TP060	★		1in 60 grit Quick Change Discs TP Style 100 pk
800-16TP080	★		1in 80 grit Quick Change Discs TP Style 100 pk
800-16TP100	★		1in 100 grit Quick Change Discs TP Style 100 pk
800-16TP120	★		1in 120 grit Quick Change Discs TP Style 100 pk
800-16TP150	★		1in 150 grit Quick Change Discs TP Style 100 pk
800-16TP180	★		1in 180 grit Quick Change Discs TP Style 100 pk
800-16TP240	★		1in 240 grit Quick Change Discs TP Style 100 pk
800-16TP320	★		2in 320 grit Quick Change Discs TP Style 100 pk

★ Available on GSA Advantage Website @ www.GSAadvantage.gov



TR Style



Coarse, Medium, Very Fine



TS Style

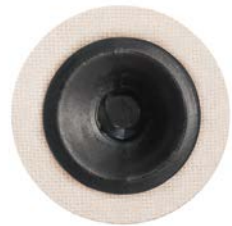

TP Style



24 Grit - 320 Grit

Quick Change Discs 2in

Ventilated Postiv-Lok quick change discs provide great dust extraction when used with Clayton shrouded grinders. The tough aluminum oxide grain makes short work of coatings and corrosion.

Quick Change - 2in TR			
Item No	GSA	NSN	Desc
800-32M003V	★	5345-01-620-6573	2in Coarse Quick Change Discs TR Style 250 pk
800-32M006V	★	5345-01-620-6415	2in Medium Quick Change Discs TR Style 250 pk
800-32M009V	★	5345-01-620-7664	2in Very Fine Quick Change Discs TR Style 250 pk
800-32M024V	★		2in 24 grit Quick Change Discs TR Style 250 pk
800-32M036V	★		2in 36 grit Quick Change Discs TR Style 250 pk
800-32M060V	★		2in 60 grit Quick Change Discs TR Style 250 pk
800-32M080V	★		2in 80 grit Quick Change Discs TR Style 250 pk
800-32M100V	★		2in 100 grit Quick Change Discs TR Style 250 pk
800-32M120V	★		2in 120 grit Quick Change Discs TR Style 250 pk
800-32M150V	★		2in 150 grit Quick Change Discs TR Style 250 pk
800-32M180V	★		2in 180 grit Quick Change Discs TR Style 250 pk
800-32M240V	★		2in 240 grit Quick Change Discs TR Style 250 pk
800-32M320V	★		2in 320 grit Quick Change Discs TR Style 250 pk

★ Available on GSA Advantage Website @ www.GSAadvantage.gov

Quick Change - 2in TS			
Item No	GSA	NSN	Desc
800-32F003V	★		2in Coarse Quick Change Discs TS Style 250 pk
800-32F006V	★		2in Medium Quick Change Discs TS Style 250 pk
800-32F009V	★		2in Very Fine Quick Change Discs TS Style 250 pk
800-32F036V	★		2in 36 grit Quick Change Discs TS Style 250 pk
800-32F060V	★		2in 60 grit Quick Change Discs TS Style 250 pk
800-32F080V	★		2in 80 grit Quick Change Discs TS Style 250 pk
800-32F100V	★		2in 100 grit Quick Change Discs TS Style 250 pk
800-32F120V	★		2in 120 grit Quick Change Discs TS Style 250 pk
800-32F150V	★		2in 150 grit Quick Change Discs TS Style 250 pk
800-32F180V	★		2in 180 grit Quick Change Discs TS Style 250 pk
800-32F240V	★		2in 240 grit Quick Change Discs TS Style 250 pk
800-32F320V	★		2in 320 grit Quick Change Discs TS Style 250 pk

★ Available on GSA Advantage Website @ www.GSAadvantage.gov

Quick Change - 2in TP			
Item No	GSA	NSN	Desc
800-32TP003V	★		2in Coarse Quick Change Discs TP Style 100 pk
800-32TP006V	★		2in Medium Quick Change Discs TP Style 100 pk
800-32TP009V	★		2in Very Fine Quick Change Discs TP Style 100 pk
800-32TP024V	★		2in 24 grit Quick Change Discs TP Style 100 pk
800-32TP036V	★		2in 36 grit Quick Change Discs TP Style 100 pk
800-32TP060V	★		2in 60 grit Quick Change Discs TP Style 100 pk
800-32TP080V	★		2in 80 grit Quick Change Discs TP Style 100 pk
800-32TP100V	★		2in 100 grit Quick Change Discs TP Style 100 pk
800-32TP120V	★		2in 120 grit Quick Change Discs TP Style 100 pk
800-32TP150V	★		2in 150 grit Quick Change Discs TP Style 100 pk
800-32TP180V	★		2in 180 grit Quick Change Discs TP Style 100 pk
800-32TP240V	★		2in 240 grit Quick Change Discs TP Style 100 pk
800-32TP320V	★		2in 320 grit Quick Change Discs TP Style 100 pk

★ Available on GSA Advantage Website @ www.GSAadvantage.gov



TR Style



Coarse, Medium, Very Fine



TS Style



24 Grit - 320 Grit



TP Style

Quick Change Discs 3in

Quick Change - 3in TR			
Item No	GSA	NSN	Desc
800-48M003V	★		3in Coarse Quick Change Discs TR Style 250 pk
800-48M006V	★		3in Medium Quick Change Discs TR Style 250 pk
800-48M009V	★		3in Very Fine Quick Change Discs TR Style 250 pk
800-48M024V	★		3in 24 grit Quick Change Discs TR Style 250 pk
800-48M036V	★		3in 36 grit Quick Change Discs TR Style 250 pk
800-48M060V	★		3in 60 grit Quick Change Discs TR Style 250 pk
800-48M080V	★		3in 80 grit Quick Change Discs TR Style 250 pk
800-48M100V	★		3in 100 grit Quick Change Discs TR Style 250 pk
800-48M120V	★		3in 120 grit Quick Change Discs TR Style 250 pk
800-48M150V	★		3in 150 grit Quick Change Discs TR Style 250 pk
800-48M180V	★		3in 180 grit Quick Change Discs TR Style 250 pk
800-48M240V	★		3in 240 grit Quick Change Discs TR Style 250 pk
800-48M320V	★		3in 320 grit Quick Change Discs TR Style 250 pk

★ Available on GSA Advantage Website @ www.GSAadvantage.gov

Quick Change - 3in TS			
Item No	GSA	NSN	Desc
800-48F003V	★		3in Coarse Quick Change Discs TS Style 250 pk
800-48F006V	★		3in Medium Quick Change Discs TS Style 250 pk
800-48F009V	★		3in Very Fine Quick Change Discs TS Style 250 pk
800-48F024V	★		3in 24 grit Quick Change Discs TS Style 250 pk
800-48F036V	★		3in 36 grit Quick Change Discs TS Style 250 pk
800-48F060V	★		3in 60 grit Quick Change Discs TS Style 250 pk
800-48F080V	★		3in 80 grit Quick Change Discs TS Style 250 pk
800-48F100V	★		3in 100 grit Quick Change Discs TS Style 250 pk
800-48F120V	★		3in 120 grit Quick Change Discs TS Style 250 pk
800-48F150V	★		3in 150 grit Quick Change Discs TS Style 250 pk
800-48F180V	★		3in 180 grit Quick Change Discs TS Style 250 pk
800-48F240V	★		3in 240 grit Quick Change Discs TS Style 250 pk
800-48F320V	★		3in 320 grit Quick Change Discs TS Style 250 pk

★ Available on GSA Advantage Website @ www.GSAadvantage.gov

Quick Change - 3in TP			
Item No	GSA	NSN	Desc
800-48TP003V	★		3in Coarse Quick Change Discs TP Style 100 pk
800-48TP006V	★		3in Medium Quick Change Discs TP Style 100 pk
800-48TP009V	★		3in Very Fine Quick Change Discs TP Style 100 pk
800-48TP024V	★		3in 24 grit Quick Change Discs TP Style 100 pk
800-48TP036V	★		3in 36 grit Quick Change Discs TP Style 100 pk
800-48TP060V	★		3in 60 grit Quick Change Discs TP Style 100 pk
800-48TP080V	★		3in 80 grit Quick Change Discs TP Style 100 pk
800-48TP100V	★		3in 100 grit Quick Change Discs TP Style 100 pk
800-48TP120V	★		3in 120 grit Quick Change Discs TP Style 100 pk
800-48TP150V	★		3in 150 grit Quick Change Discs TP Style 100 pk
800-48TP180V	★		3in 180 grit Quick Change Discs TP Style 100 pk
800-48TP240V	★		3in 240 grit Quick Change Discs TP Style 100 pk
800-48TP320V	★		3in 320 grit Quick Change Discs TP Style 100 pk

★ Available on GSA Advantage Website @ www.GSAadvantage.gov



TR Style



Coarse, Medium, Very Fine



TS Style

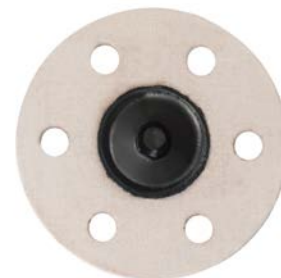

TP Style



24 Grit - 320 Grit

Vacuums

The **Hornet** HEPA vacuum is air powered and rated for the collection of combustible dusts like aluminum. It can also be used for FOD cleanup, dustless sanding, or general cleaning. The kit is turnkey, and include sanders, accessories, the vacuum, and more. Kit is in the NAVAIR 509 manual for corrosion control.



Hornet Vacs			
Item No	GSA	NSN	Desc
ACE-1000		7910-01-390-5761	Clayton Pneumatic Combustible Dust Vac Sanding Kit
627-516H		4460-01-519-5158	HEPA filter for Clayton Hornet & Scorpion Vacs
690-A0031		4460-01-519-5125	Filter bag for Clayton Hornet Vac
900-A001-30		6150-01-671-8172	Aircraft Grounding Wire & Plug 30 ft
600-114DM		8105-01-521-2119	Garbage bag 30gal 25pk



900-A001-30

627-516H

690-A0031

DustMaster™ Cyclonic HEPA Vacuum Sanding Kits were designed in cooperation with NAVAIR and USAF maintainers. They provide the power and features to support up to 3 simultaneous users. They offer complete tool control with a consolidated tool kit, shadow-boxed foam, and internal hose storage.

Dustmaster Vacs			
Item No	GSA	NSN	Desc
660-DM-1000-4		5130-01-413-9122	Clayton 3 user Pneumatic Vacuum System - 5 Sander Kit
670-DM-1535-0		5130-01-551-2270	Clayton 3 user Electric Vacuum System - 6 Sander Kit
600-313A		7910-01-520-6435	Filter Bag Dustmaster 5pk
610-313A		4310-01-520-8595	Filter Bag Dustmaster Cyclone 10pk
600-115		4310-01-519-5205	Pre-Filter Dustmaster 3pk
600-116		4310-01-519-5796	ULPA Filter U15 DustMaster 1pk
600-114DM		8105-01-521-2119	Garbage bag 30gal 25pk

5 Sander Kit 5130-01-413-9122	6 sander Kit 5130-01-551-2270
(1) HEPA Vac (2) 3in Sanders (2) 6in Sanders (1) 2in Grinder (2) 20ft Hoses (1) 30ft Hose	(1) HEPA Vac (2) 3in Sanders (2) 6in Sanders (1) 3x4in Sander (1) 3x7in Sander (2) 20ft Hoses (1) 30ft Hose
Over 1500 sheets of assorted abrasives, backup pads, filters, and accessories	Over 4000 sheets of assorted abrasives, backup pads, filters, and accessories
NAVAIR 509 Authorized	NAVAIR 509 Authorized



600-313A

600-116

600-115

610-313A

600-114DM

This **Warthog** series air powered HEPA vacuum holds 7 gallons of debris in it's polyethylene vacuum tank. True HEPA filtration make these vacuums suitable for lead, asbestos, hexavalent chromium, strontium, and other toxic and hazardous dust and debris. Made in the USA from industrial quality components, these vacuums are made to last for years.

Warthog Vacs			
Item No	GSA	NSN	Desc
WTP-107T-4	★		Pneumatic HEPA Vacuum, 7 Gallon for general or hazardous cleanup
627-12H		4310-01-520-6794	HEPA filter for Clayton HEPA vacs

★ Available on GSA Advantage Website @ www.GSAadvantage.gov



WTP-107T-4



600-114DM

Warthog Bags and Filters for our HEPA Vacuum line.

Vacuum Bags - Clayton Vacs			
Item No	GSA	NSN	Desc
627-16B		7910-01-459-0352	Filter bag for Clayton 15g HEPA vacs 5pk
00510		7910-01-458-9363	PreFilter for DCM Infiltrator 15g HEPA vacs 2pk
600-114DM	★		Garbage bag 30gal 25pk



627-16B



00510



627-12H

Our portable pneumatic recirculating Spot Blaster is a tiny powerhouse. It removes corrosion and coatings from fasteners and small areas. You choose your blast media, and this tool does the rest. A pull of the trigger, and the media is safely delivered in a enclosed concentrated blast. The integrated Scorpion HEPA vac collects and recirculates the media. Kit includes the Spot Blaster, multiple nozzle tips, extra HEPA filters and pre filters.

Spot Blaster			
Item No	GSA	NSN	Desc
PR-100MK		4920-01-662-3614	Piranha Recirculating Spot Blast Military Kit
627-516H		4460-01-519-5158	HEPA Filter for Clayton Hornet & Scorpion Vacs
627-516P	★		Pre-Filter Scorpion 5pk



627-516H



Personal Gear

Keep your tools, equipment, and valuables safe. The brass lock can be set to your own numeric combination. If you forget your combination, there's a cordless grinder with a cutoff wheel available on the following pages.

Lock			
Item No	GSA	NSN	Desc
955-TBACC-02		5340-01-519-0782	Combination Padlock



Set Your Own
4-Digit Number Combination

Our desert military boot sock - comfortable yet rugged footwear that stands up to the rigors of harsh climates and protects you in the most strenuous conditions. An acrylic and wool blend wicks moisture away, keeping feet dry & cool. Silver Lining™ battles bacteria and helps to eliminate foot odor and blisters. Kit includes 5 pairs of coyote socks a small 4oz bottle of Americas favorite foot powder.

Socks			
Item No	GSA	NSN	Desc
00352	★		Desert Military Boot Socks 5 pair, Tote Bag and Gold Bond Foot Powder

★ Available on GSA Advantage Website @ www.GSAadvantage.gov



Whether you're turning wrenches, carrying gear, or pulling triggers, these are the best gloves available to get the job done. Manufactured for Clayton by Mechanix, these award winning gloves are used around the world. Kit includes 10 pairs of gloves in a ballistic nylon tool bag.

Gloves - TAA			
Item No	GSA	NSN	Desc
132082T	★		Glove Kit Coyote - 10 pair Medium gloves and tote bag TAA Compliant
130153T	★		Glove Kit Coyote - 10 Large gloves and tote bag TAA Compliant
130154T	★		Glove Kit Coyote - 10 pair gloves (5 XL & 5 XXL) and tote bag TAA Compliant

★ Available on GSA Advantage Website @ www.GSAadvantage.gov



When Berry Compliance is required, these Tactical work gloves designed for military and law enforcement professionals are the same as our TAA Compliant Gloves but made in the USA.

Gloves - Berry			
Item No	GSA	NSN	Desc
132082	★		Glove Kit Coyote - 10 pair Medium gloves and tote bag Berry Compliant
130153	★		Glove Kit Coyote - 10 pair Large gloves and tote bag Berry Compliant
130154	★		Glove Kit Coyote - 10 pair gloves (5 XL & 5 XXL) and tote bag Berry Compliant

★ Available on GSA Advantage Website @ www.GSAadvantage.gov



Pneumatics

Compressed Air fittings help make connections.

Compressed Air Fittings			
Item No	GSA	NSN	Desc
940-016		4730-01-519-7442	Fitting Plug 1/4in HiFlow x 1/4in MNPT
940-202		4730-01-520-6072	Coupler 1/2in FNPT w/Brass Union
940-201		4730-01-520-6815	Coupler 3/4in FNPT w/Brass Union
924-1002		4820-01-520-3609	Ball Valve 1in Brass



Compressed Air Fittings			
Item No	GSA	NSN	Desc
926-A75R		4820-01-520-7106	Regulator 3/4 in
925-P32R160-01		6685-01-519-2776	Gauge Pressure 2in 0-160 PSI Panel Mount



Compressed Air Fittings			
Item No	GSA	NSN	Desc
940-009		4730-01-519-7432	Inflator / Deflator with Fittings
940-010		4730-01-519-7409	FTG Plug with Blowgun

Handheld blow gun with safety tip and fitting included.



The Inflator / Deflator kit gives you the tools you need to pressurize and deflate tires in a controlled manner. Each kit includes the inflator/deflator with gauge, long reach tire chuck and lock on tire chuck.



Timer cards provide an easy way to monitor service intervals on tools and equipment. Just activate the card, and the timer gauge counts down at a prescribed speed until the interval is reached.

Timer Cards			
Item No	GSA	NSN	Desc
627-T06S		9905-01-666-7153	Timer Card 6 Month Service Required
627-T12S		4330-01-633-7988	Timer Card 12 Month Service Required



Hold Down

4-pack of High Efficiency Pressure Applicator (HEPA) Clamps. Hold parts together during fabrication, as you weld, or wait for adhesives to dry. Each kit includes 4 large clamps, pipe adapters, tripod stand, spreader clips, one pair of tactical work gloves, and a ballistic nylon tool bag.

Hold Down			
Item No	GSA	NSN	Desc
690-PTC-02		5340-01-519-3065	Trigger Clamp 8 pack

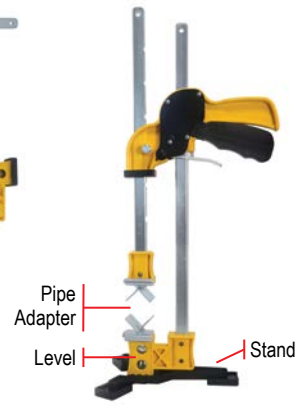

Versatile 4 Way Clamp

All stainless steel ratchets make these the best straps you've ever had and the last straps you'll ever need. Straps are 1-1/2in x 10ft with heavy duty vinyl coated hooks and an extra 3ft webbing loop for areas where the hooks don't fit. Kit includes 4 sets of straps, one pair of tactical work gloves, and a ballistic nylon tool bag.

Hold Down			
Item No	GSA	NSN	Desc
930-A010		5340-01-519-3073	Ratchet Strap Kit



4 Ratchet Straps



1000 piece cable tie supply kit. Kit contains durable high-quality black UV resistant cable ties - 500 x 11" ties and 500 x 5" ties. The large ties are rated at 50 lbs. and the small at 40 lbs.

Hold Down			
Item No	GSA	NSN	Desc
930-A005		5340-01-519-3071	Cable Tie Kit 1000pc



Material Handling

These German engineered high quality casters are used on many of our vacuum systems for a reason. These wheels are designed for years of heavy duty use, and are capable of handling rough surfaces like concrete, asphalt, and non-skid decking. Each caster is 5" in diameter, and they use identical mounting patterns.

Casters			
Item No	GSA	NSN	Desc
610-160.5		5340-01-519-3087	Caster Rigid Non-Locking 5in Military Kit
600-159.5LOCK		5340-01-519-5798	Caster Swivel Locking 5in Military Kit



610-160.5



600-159.5LOCK

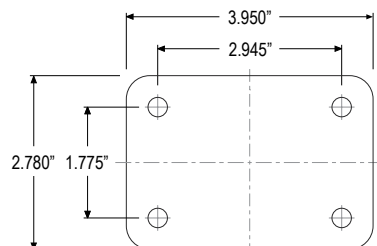

This hand truck makes work easier. This handy tool of the trade is durable and designed to simplify heavy lifting tasks.

Material Handling			
Item No	GSA	NSN	Desc
650-141		3920-01-519-5811	Hand Truck



650-141

Hoses

Combo Hoses - Air & Vac			
Item No	GSA	NSN	Desc
671-AVHW2416-10		4720-01-652-0544	Air Vac Combo Hose 1.5in X 1in X 10ft
671-AVHW2416-40		4720-01-519-7365	Air Vac Combo Hose 1.5in X 1in X 40ft

Combo Hoses are 1-1/2" crush proof conductive vacuum hose terminating in 1 in raw vacuum hose for connection to sanders and shrouded tools and a compressed air line with fittings to power those tools from our vacuums or other compressed air source.



Combo Hose

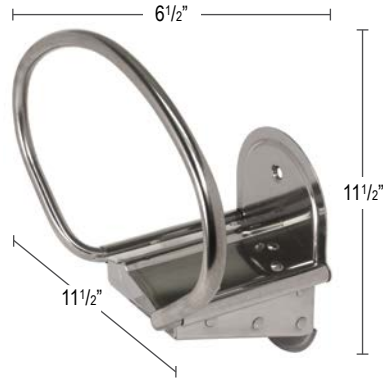

Combo Hoses - Air & Vac			
Item No	GSA	NSN	Desc
650-012-KIT		5340-01-519-0761	Hose Holder Kit (Large)

Keep your vacuum hoses, compressed airlines, power cords, and water hoses off the floor and organized with our large stainless steel wall mount hose holder.

Non sparking conductive air line with stainless steel fittings terminates in a 1/2" Parker industrial interchange safety coupler and industrial interchange plug which is threaded on for easy removal if needed. Safety Coupler bleeds downstream air before unlocking from plug.



Compressed Air Hose
1/2in SS Fittings

Compressed Air Lines			
Item No	GSA	NSN	Desc
92X-A08H30-II		4720-01-663-1575	Compressed Air Hose 1/2in x 30ft Exp Fittings

Power

This 7 outlet power strip switch kit. Includes built in cord wrap for the 9ft power cord, lighted on/off switch, 3x one foot pig tails for those annoying devices with power packs. ETL Listed with 600 joule surge suppression.

Electric Power			
Item No	GSA	NSN	Desc
900-032-Kit		5930-01-519-9249	Power Strip Switch Kit
600-A126		6150-01-519-4401	Extension Cord 12/3 20A Cord Lock Plug 50ft Yellow



600-A126



900-032-Kit

Extend Your Reach with this 12 gauge 50ft extension cord. Heavy duty UL Listed cord in safety yellow includes light up receptacle to indicate power and an easy carry velcro wrap with handle.

SECTION 2

MIPR & MILSTRIP

Purchase Through DLA Tailored Logistics Support Programs using MIPR and MILSTRIP funding

- AbilityOne Base Supply Center Tailored Logistics Support Program
- DLA Tailored Logistics Prime Vendor

Contact sales@jclayton.com to get the process started. A Clayton representative will prepare all the paperwork for the customer to submit to DLA.



Scan this QR code
to download the latest
NSN Catalog



Scan this QR code
for a list of
Base Supply Centers

RHINO

MOBILE WORKCENTER

The Clayton Rhino Mobile Work Center is a full featured work center designed specifically around the needs of aerospace composite repair and LO professionals.

The Rhino provides vast storage space for all your tools and two-color foam is included to maintain compliance with tool control tech orders. The side doors swing 180° to support the hinged cover, revealing a spacious 10' work surface covered in a self healing cutting mat, surrounded by a border of cork to protect cutting tool blades.

A retractable 50' electrical cord provides power to the Rhino internal and external electrical charging stations and allows for electrical distribution and overnight charging of battery operated tools. Charging can occur even when the kit is locked and secured.

Get the Rhino Mobile Work Center alone or the Rhino Mobile Work Center for Vacuum Sanding which includes two portable Clayton Hornet HEPA vacuums for source capture dust collection and for FOD cleanup. It also includes vacuum sanders and accessories, and an assortment of cleanup tools.



Rhino Mobile Work Center			
Item No	GSA	NSN	Desc
RH-500-01			Rhino Mobile Work Center (Empty)
RH-500-02			Rhino Mobile Work Center for Vacuum Sanding

Rhino Mobile Work Center Vacuum Sanding Contents		
Item No	Description	Qty
500-400	Hornet HEPA Vac	2
671-AVHW1616-08	Air/Vac Combination Hose 8ft	2
922-A08H30-EXP	Compressed Air Supply Hose	2
670-12501J	Clayton 5in Vacuum Sander	2
675-12301J	Clayton 3in Vacuum Sander	2
642-24V11001	Crevice Tool - Poly 1.5in x 11in	1
642-24G05001	Gulper Tool - Poly 1.5in x 5in	1
642-24R03001	Dust Brush - Poly 1.5in x 3in Horsehair	1



Clayton Chainsaw Massacre! Hit the landscape hard with these professional tools designed to help you take out your aggressions on Mother Nature. Grass, leaves, hedges, weeds, branches, and even whole trees will quake at the sound of this kit - although it's so quiet they probably won't hear you coming. 60 Volt Kit includes the blower, chainsaw, and the string trimmer, which can swap heads to become an edger, a hedger, or a pole saw. Each kit is equipped with three 60V batteries, three chargers, and extra trimmer string. So stop watching the grass grow and get to work making the world a more beautiful place.

Outdoor Cutters			
Item No	GSA	NSN	Desc
690-PTO-01			Outdoor Power Equipment Kit



Safety Glasses
(3 Pair)



Tactical Work Gloves
(3 Pair)



Nitrile Gloves 50pk



Cordless Chainsaw
60V MAX FLEXVOLT



Cordless 600 CFM Blower
60V MAX FLEXVOLT



Edger Attachment



Cordless String Trimmer
60V MAX FLEXVOLT



Hedge Trimmer
Attachment



Pole Saw
Attachment



FOD Blower Kit. A Leaf Blower is one of the most versatile outdoor tools to have in your arsenal. In addition to Summer and Fall cleanup, it can be used to quickly remove debris from many areas including shop floors, hangers, flight lines, and carrier decks. Remember to wear your safety glasses and tactical work gloves, included.

Outdoor Maintenance			
Item No	GSA	NSN	Desc
690-PTO-02			Blower Kit



Brushless 600 CFM Blower
60V MAX FLEXVOLT



Tactical Work Gloves



Safety Glasses

Our **Mobile Deployment Kit** includes items every soldier needs. The mobile job box has 6 cubic feet of storage, large wheels for uneven terrain, and a pull out handle. Kit includes 5 nylon write-on name tags for all your gear, a combination padlock, 10 gear carabiners, 1 pair of the best socks you will ever wear, and a cargo net to secure your gear to the top of the box.

Mobile Deployment Kit			
Item No	GSA	NSN	Desc
955-TB012NW			Mobile Deployment Kit



Tactical Work Gloves



Padlock

Rucksacks not included



Retractable Pull Handle

Tie Down Points

Combination Padlock

Built-in Keyed Lock

Large Wheels for Uneven Terrain

Large Latches with Lockable Hasp

Wheeled Tote
36w x 23d x 24h



1 Sharpie & 5 Gear Name Tags



10 Gear Carabiners

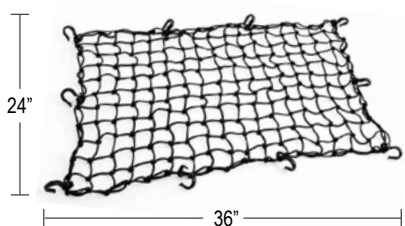

24"

36"

Clip-On Cargo Net



Socks



MOBILE TOOL CRIB

1 Box | 11 Tools

Tool Crib in a Box – or as we call it at Clayton, the “Everything Bagel”. This deployment tool kit gives you almost every tool you need, and all the bits, blades, and supporting consumables. This amazing kit includes a grinder, jigsaw, circular saw, reciprocating saw, hammer drill, drill and impact driver, gloves, bits, box cutter, tape measure, level, and a cordless HEPA vacuum. Everything fits in the portable job box, and we even include a padlock so you can keep snooping co-workers out of your tools. Put this kit on order today, and have everything you need, all in one place.



Mobile Tool Crib			
Item No	GSA	NSN	Desc
690-PTX-01			Mobile Tool Crib



Grinding Wheels



Cordless Grinder



Scorpion Pneumatic Vacuum



INCLUDES
DUST COLLECTION



Padlock



Circular Saw



Carbide Tipped
Circular Saw Blades



Reciprocating
Saw



Reciprocating
Saw Blades



Jigsaw

- Blades:**
- 20 x Fine
 - 20 x Coarse
 - 20 x Tight Radius Cut
 - 20 x Extreme Radius Cut



Drill Bit Jobber Set



Hammer Drill



Impact Driver



Drill / Driver



1/4" Hex Shank Bits



Cordless HEPA Vac



Tactical
Work Gloves



24in Magnetic Level



Step Bits



Retractable
Utility Knife

Tape Measure

Tool Control Foam is essential to managing tool boxes and kits. This kit includes 12 sheets of charcoal 1" foam with PSA, 12 sheets of yellow 1/8" foam, two silver permanent markers, 2 small and 2 large snap-off blade knives, 48" aluminum straight edge, 6' tape measure, and a ballistic nylon gear bag.

Foam Kit			
Item No	GSA	NSN	Desc
150075			Posi-Vac Tool Control Foam Starter Kit



Tote Box includes tote with 14 internal bins 3-1/2" deep. Great for holding abrasive discs, fittings, screws, legos, etc.

Tote Box			
Item No	GSA	NSN	Desc
175123			Tote Box with Bins (Military Version)



TWIN TECH

AVIM WORKCENTER

The AVIM Kit complements and enhances currently fielded Army AFL's, and is an essential tool kit for all military structural or composite shops. The shrouded tools and vacuums included, reduce exposure to hex chrome, heavy metal dust, and eliminate FOD. Bidirectional drawers provide the same tools for two users with no tool redundancy to current AFL's or shop equipment.



AVIM Mobile Workcenter			
Item No	GSA	NSN	Desc
00928			Twin Tech Aviation Kit AVIM



Includes:

- 1" Drum Sander Shroud (2 each)
- 2" Edge Trimmer Shroud (2 each)
- 1-1/4" Shrouded Denibber (2 each)
- 1", 2", & 3" Clear Revolution Shrouds (2 each)



Includes:

- 3", 5", 6" Random Orbital Sanders (2 each)
- 3 x 4" Orbital Sander (2 each)
- Corner Sander (2 each)



Includes:

- 3" Cutoff Saw (2 each)
- 4" Cutoff Saw (2 each)
- Straight Grinder (2 each)
- Right Angle Grinder (2 each)
- Belt Sander (2 each)
- Bristle Disc Shroud (2 each)



Includes:

- 1" and 2" Slipped Fixed Drill Guides (2 each)
- Assorted Drill Bushings (2 sets)
- Seat Track Shroud (2 each)
- Seat Track Abrasive (100 pcs)
- Right Angle Drill Shroud (2 each)
- Soft Drill Shroud (1 each)



Includes:

- Vacuum Dust Brush (1 each)
- Vacuum Y Adapter (1 each)
- Radius Sander (2 each)
- 5" Hand Sander Shapes Kit (2 each)
- 16" Hand Sander Rigid (1 each)
- 16" Hand Sander Flex (1 each)



Includes:

- Scorpion Compressed airline and Hose (1 each)
- Clear FOD Wand (1 each)
- Flex-Loc FOD Wand (1 each)
- Crevice Tool (1 each)

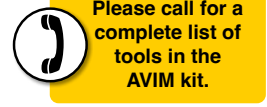

Please call for a complete list of tools in the AVIM kit.

MOBILE PAINT BOOTH

The Clayton Mobile Paint Booth is a portable inflatable enclosure that allows painting almost anywhere. The booth evacuates overspray and keeps the inside of the booth free of airborne particulate. Each unit has a wide entrance, allowing easy access with large parts or rolling carts. The clear side panels provide plenty of light to illuminate the work area. The entire booth, powered by 120V portable blowers, inflates in under 2 minutes. Deflated, it fits into a forkliftable composite crate.

Each kit includes: Inflatable Booth, Blower, and storage crate.

Mobile Paint Booth			
Item No	GSA	NSN	Desc
CC-PB151510-01			Mobile Paint Booth 15x15x10 with Lighting
CC-PB402312-01			Mobile Paint Booth 40x23x12 with Lighting



Neshap Filter / Carbon Filter Panels discharge clean filtered air



Filtered air enters booth at the rear



**Contaminated air exits through side filters
Main Entry unzips for large vehicle access**



**23ft x 40ft Booth
6 side windows and front entry windows let in plenty of light.**

The **Tent & Vent** is a high flow air filtration unit designed to allow aircraft painting on the hangar floor without exposing workers to overspray and VOCs. This unit adheres to NESHAP Test Method 319 for Aerospace painting and de-painting operations and meets all standards for the safe evacuation and filtration of chromated primers and other coatings. The powerful air motor delivers over 1200 cfm of air flow to easily evacuate 12x10x10 painting tents. The air powered system consumes 60 CFM @ 90 PSI. NSN includes Tent & Vent, 18" inlet extension, 12" muffler, grounding cable, 30' compressed air line, poly film, and a supply of primary and secondary filters to ensure that you'll be operational upon receipt of the unit.

Testing performed by the US Military showed that the Tent & Vent maintained exposure levels below both the Action Level and the Occupational Environmental Exposure Limit for Hexavalent Chromium.

Tent & Vent			
Item No	GSA	NSN	Desc
TV-1400-KIT1			Tent & Vent with Accessory Package
TV-1400-Kit2			Consumable Replenishment Kit for TV-1400



Consumable Replenishment Kit Contents

- Extra Filters (1 case of each)
- Intake Filter Media
- Exhaust Poly Ducting
- 4 Mil Tenting Film
- Rosin Paper Floor Covering
- Masking Tape
- Tactical Shears
- Cleaning Wipes



What happens when you turn a downdraft table on its side?

BackDraft - HEPA filtered small parts grinding/sanding station. It Devours Dust.

This walk up workstation devours debris from sanding and grinding operations. Parts up to 30 inches wide fit in its enclosed work area and 1350 CFM of airflow pulls dust into its 3 stage filtration system.

Grinding Station			
Item No	GSA	NSN	Desc
GS-1350-01			Grinding Station 1350

Features:

- Three Stage Filtration
- Stage 1 MERV 8 Primary Panel Filter
- Stage 2 MERV 13 Secondary Panel Filter
- Stage 3 HEPA Cartridges filter 99.97% of particles down to 0.3 μm
- Differential pressure gauges monitor filters
- Large work area 31w x 12d x 13h
- Overall 32w x 37d x 50h x 300 lbs
- Requires 120V 20A circuit

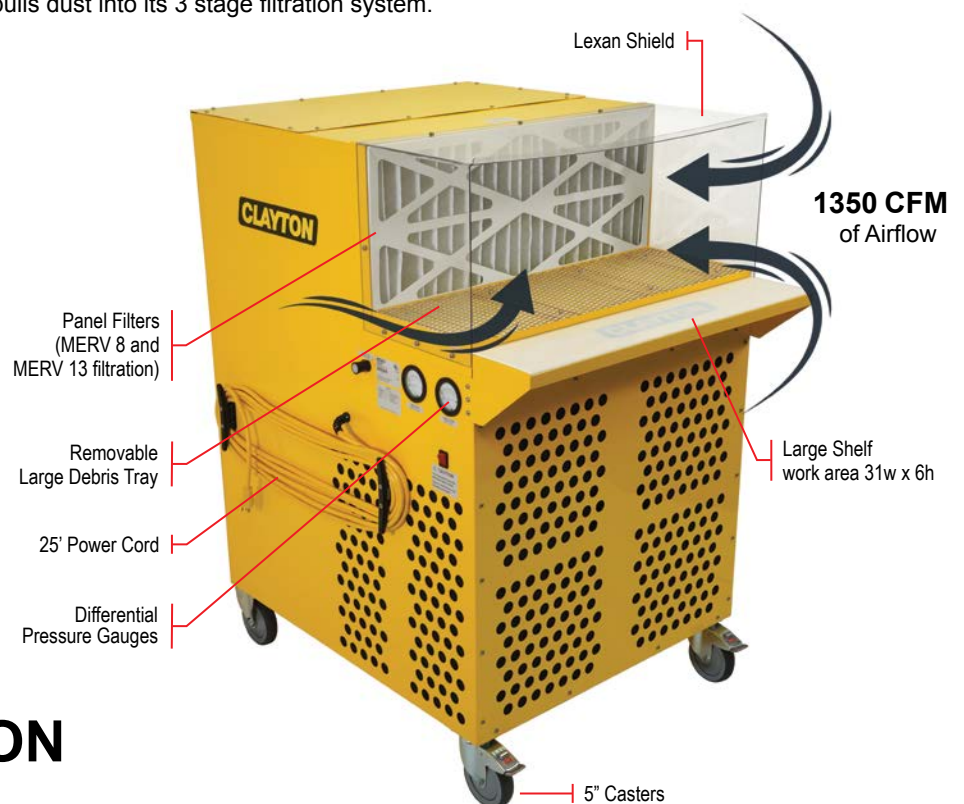

DOWNDRAFT BACKDRAFT GRINDING STATION

Open Wide! Our Gate Mouth Tool Bag is made by hand here in the US to support maintenance operations and is rugged enough to survive whatever you can throw at it, or however many times you throw it. Made from 1000 denier cordura with 6 exterior pouches, tough wire supported opening, and heavy duty grab handles. If you need to store or carry tools, equipment or supplies, this is your solution. Go Bag or Go Home.

Tool Bag			
Item No	GSA	NSN	Desc
955-TB030-1			Gate Mouth Tool Bag



Get your hands on this kit write away! **The Vacu-Sheet & Folio Pen Kit** includes 5 non-reflective Skilcraft B3 Aviator multi-function black/red ball point pen, pencils, and a rugged 6-1/2 x 9-1/2 Folio of Vacu-Sheets. Great for logging vacuum or equipment maintenance.

Folio Pen Kit			
Item No	GSA	NSN	Desc
163-PENFOLIO-01			Aviator Pens & Folio

5 Skilcraft B3 Aviator Pens
(Black/Red Ball Point Pen, Pencil)



All Lit Up! The 650 Lumen Ergo Lite Headlamp has 5 modes including strobe. Powered by 4 AA batteries and just in case you run out of power, we've also included 144 lithium ion AA batteries and a rugged nylon tool bag.

Ergo Lite			
Item No	GSA	NSN	Desc
690-PTL-02			Ergo Lite Head Lamp Battery Kit



144 AA BATTERIES

The **Posi-Vac Essentials Tool Kit** was designed as a starter kit to support corrosion control technicians. The kit includes a white/red/green rechargeable inspection flashlight, USB cable, Leatherman Multitool, 2 Skilcraft B3 aviator multi-function black/red ball point pen, pencil, with non-reflective coating, and meets all FOD requirements.

Toolkit			
Item No	GSA	NSN	Desc
130093			Tactical Flashlight, Multitool, Aviator Pens Kit



2 Skilcraft B3 Aviator
(Black/Red Ball Point Pen, Pencil)



Nylon Sheath



Leatherman
Multitool



10 Lumen



70 Lumen



300 Lumen



800 Lumen



Green



Red

Magnetic Base



Rechargeable
Inspection Flashlight



Swivel Head

The **Posi-Vac Backpack Tool Kit** was designed as a starter kit to support corrosion control technicians. The kit includes a rugged black backpack, Leatherman multitool, white/UV rechargeable inspection flashlight, USB cable, safety glasses, tactical work gloves, socks, and a microfiber towel, which can be used to wipe down aircraft, dry off a wet warfighter, or it can even be used as a blanket for those long hops on cargo aircraft. The backpack is designed as a 3-day pack with soft pockets for sunglasses, and plenty of storage for tools, clothing, laptops, etc.

Backpack Tool Kit			
Item No	GSA	NSN	Desc
150155			Backpack Starter Kit Posi-Vac



Tactical Work Gloves

Swivel Head



Rechargeable
Inspection Flashlight

90 Lumen

300 Lumen

UV

Magnetic
Base



Socks



Nylon Sheath



Leatherman
Multitool



Safety Glasses



Microfiber Towel



Backpack

Flashlight Kit			
Item No	GSA	NSN	Desc
17285GH			Ergo Lite Flashlight Kit

The **Flashlight Inspection Kit** includes both a white/red/green inspection light for finding paint defects and a white/UV inspection light for oil leaks and crime scenes. Both flashlights have 90 degree swivel heads, magnetic bases and are USB rechargeable. Kit includes 2 inspection lights, safety glasses, and nitrile gloves to keep your hands clean during inspections.



Nitrile Gloves 50pk



10 Lumen



70 Lumen



300 Lumen



800 Lumen



90 Lumen



300 Lumen



Safety Glasses



Magnetic
Base

Rechargeable
Inspection Flashlight

Swivel Head



Green



Red

Swivel Head



Rechargeable
Inspection Flashlight



UV

Magnetic
Base

Construction Grade Tools These construction grade tools will make short work of your next project. Each kit includes tools, a heavy duty backpack tool bag, and accessories. These tools use the most powerful batteries available today.

Sink Your Teeth Into This Kit! The Cordless Saw Kit includes both reciprocating and circular saws, along with 10 carbide tipped circular saw blades, 32 reciprocating saw blades, tactical work gloves, and a rugged ballistic nylon tool bag.

Construction Tools			
Item No	GSA	NSN	Desc
690-PTS-01			Cordless Saw Kit, Circular & Reciprocating



Scorpion Pneumatic Vacuum

Bigger Isn't Better! The Atomic 4-1/2" circular saw is perfect for cuts up to 3/4" deep. Small enough to control with one hand and powerful enough to breeze through 3/4" plywood, it's like a lithium ion piranha. Kit includes circular saw, 5 carbide tipped wood cutting blades, tactical work gloves, and a rugged ballistic nylon tool bag.

Circular Saw 4-1/2in Kit			
Item No	GSA	NSN	Desc
690-PTS-03			DeWalt Cordless 4-1/2in Circular Saw Kit



Scorpion Pneumatic Vacuum

Get Jiggy With It! – Cordless Jigsaw Kit includes saw, 80 blades, charger, battery, tactical work gloves, and a rugged ballistic nylon tool bag.

Jigsaw			
Item No	GSA	NSN	Desc
690-PTS-02			Jigsaw Cordless Starter Kit with Blades

Includes:



-  20 x Fine
-  20 x Coarse
-  20 x Tight Radius Cut
-  20 x Extreme Radius Cut



Scorpion Pneumatic Vacuum



Chop Chop! The Cordless Sliding Compound Mitre Saw is a powerhouse! Its powerful 120V motor can be powered by a pair of 60V batteries or it can be plugged into a standard outlet (batteries and adapter included). The kit includes saw, collapsible stand, extra blades (fine and coarse), resin bond metal cutoff wheels, and a scorpion air powered vacuum for dust collection.

Mitre Saw Kit			
Item No	GSA	NSN	Desc
690-PTM-02			Sliding Compound Mitre Saw 12in Cordless/Corded



Scorpion Pneumatic Vacuum



Oscillating Multitool

This tools offer tremendous flexibility for cutting, scraping, sawing, and sanding in tough to reach areas. Kit includes an assortment of saw blades, sanding pads, abrasives, batteries, tactical work gloves and a rugged ballistic nylon tool bag.

Multitool			
Item No	GSA	NSN	Desc
690-PTM-01			Multitool Sander Kit



Take the Easy Route! The Corded Router Kit includes a powerful 2.25 HP motor and three versatile bases for general woodworking, plunge routing, or the universal D-handle for the best in ergonomics. It also includes router bits, tactical work gloves, rugged ballistic nylon tool bag and a portable pneumatic HEPA vacuum to control dust. Outfit your woodshop today and be the envy of your team.



Construction Tools			
Item No	GSA	NSN	Desc
690-PTR-01			Corded Router Kit with Vacuum and Bits



Construction Tools			
Item No	GSA	NSN	Desc
690-PTG-01			Cordless Grinder Kit, 4.5 in with 20 Discs
19449			4.5in Grinding Wheel 100pk
152500			Flap Disc 80 grit 4-1/2in x 5/8-11 x 50pk

The Cordless Grinder Kit uses a 4.5" grinding wheel to make short work of metals of all types, or add a flap disc or abrasive disc to sand wood and carve totem poles. Kit includes grinder, tactical work gloves, rugged ballistic nylon tool bag, batteries, and 20 grinding wheels.



The Rotary Hammer is purpose built for drilling in masonry and concrete, or switch to hammer only mode for light chipping and demolition. Kit includes drill, 5pc carbide hammer bit set, tactical work gloves, rugged ballistic nylon tool bag, and a dust shroud to comply with new OSHA silica requirements.

Rotary Hammer			
Item No	GSA	NSN	Desc
690-PTH-01			Rotary Hammer Kit with Dust Collection Shroud



The Demolition Hammer is a 120V beast, making short work of concrete and stone. Kit includes Demolition Hammer, tactical work gloves, rugged ballistic nylon tool bag, and a dust shroud to comply with new OSHA silica requirements. Extra chisels sold separately.

Demolition Hammer			
Item No	GSA	NSN	Desc
690-PTH-02			Demolition Hammer with Dust Shroud
60411			Chisel Set, Flat, Point, & Scaling Tips (3 chisels)

Chisel Set, Flat, Point, & Scaling Tips (3 chisels)



Hammer Time includes 5 types of hammers, including Drilling Sledge, Bricklayer/Pick, Framing, Ball Peen, Engineering, and a 16in pry bar, tactical work gloves, and a rugged ballistic nylon tool bag.

Hammer Time			
Item No	GSA	NSN	Desc
60663			Hammer Set, 6 Piece



Get excited about our **Boring Kit!** Includes 14 spade bits (1/4" - 1-1/2"), 13 hole saws (3/4" - 2-1/2"), and a powerful drill with anti-rotation E-Clutch, tactical work gloves, and a rugged ballistic nylon tool bag.

Hole Boring Kit			
Item No	GSA	NSN	Desc
153090RB			Hole Saw Drilling Kit



The Hammer Drill can be used for standard drilling in wood and metal, or switched to hammer mode for concrete and masonry. Kit includes drill, batteries, tactical work gloves, rugged ballistic nylon tool bag, and dust collection shroud.

Hammer Drill Kit			
Item No	GSA	NSN	Desc
690-PTD-01			Hammer Drill Kit with Soft Drill Shroud
7BH-M-KIT1			Masonry Drill Bit Set (3/16, 1/4, 3/8, 1/2, 5/8, 3/4)



Hammer Drill Kit	
NSN	Description
7BH-M1875	Masonry Bit 3/16in
7BH-M2500	Masonry Bit 1/4in
7BH-M3750	Masonry Bit 3/8in
7BH-M5000	Masonry Bit 1/2in
7BH-M6250	Masonry Bit 5/8in
7BH-M7500	Masonry Bit 3/4in

The Drill Driver Kit includes two industry leading tools – the cordless impact driver accepts 1/4" hex shank bits, and the drill/driver's 3/8" chuck handles most tasks. Kit includes tools, batteries, tactical work gloves, rugged ballistic nylon tool bag, bit set, and 12 each cobalt aviation bits in 1/4", #10, #21, #30, and #40 sizes.

Drill Driver Kit	
NSN	Description
690-PTD-02	Drill Driver Kit with Accessories
7BC-S-KIT3	Drill Kit Jobber Cobalt Replenishment 300PC



Step Up Your Game! Step bits are the best way to cut clean holes in steel, aluminum, and plastic. These high speed bits have a 1/4" hex shank, and can be used in a normal drill or an impact driver. Three different size bits cut holes ranging from 1/8" to 7/8", and the spiral flutes remove material quickly, leaving no burrs or sharp edges.

Step Bits			
Item No	GSA	NSN	Desc
690-PTB-02			Step bit 3 piece set



Bit by Bit - The Drill Bit Index includes all the most common fractional bits. Each bit is Cobalt construction, ensuring a clean cut and a long life. 29 Jobber bits range from 1/16 to 1/2, and are packaged in metal case for tool control. Add this kit to your toolbox, and you'll have a hole lot of fun!

Jobber Drill Index			
Item No	GSA	NSN	Desc
7BC-S-KIT1			29pc Drill Bit Jobber Set (1/16in - 1/2in)

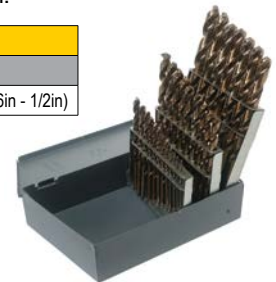

Die Grinder Kit with 1/4in collet. No power cord, no airline! Kit includes grinder, batteries, set of cross cut burrs, tactical work gloves, and a rugged ballistic nylon tool bag.

Die Grinder			
Item No	GSA	NSN	Desc
690-PTG-02			Cordless 1/4in Die Grinder Kit with Accessories



Right On! Sometimes you need just the right angle to get into tight spaces. Our right angle drill kit includes cordless right angle drill, 29pc Jobber drill index, driver bit set, tactical work gloves, and a rugged ballistic nylon tool bag.

Right Angle Drill Kit			
Item No	GSA	NSN	Desc
690-PTD-03			Drill Kit, Right Angle, 20V with Accessories



Looking Buff! The Buffer/Polisher kit includes a 5" Random Orbital (DA) buffer with hook & loop pad for finishing and polishing at 2000 - 5500 rpm. Kit includes buffer, battery, charger, and an assortment of polishing, buffing pads, tactical work gloves, and a rugged ballistic nylon tool bag.

Buffing Kit			
Item No	GSA	NSN	Desc
690-PTB-01			Cordless Buffer Kit 5in DA & Pads



Foam Polishing, Finishing, Cutting Discs



Microfiber Compound Discs



Microfiber Cutting Discs



Microfiber Finishing Discs

Band-Aids Not Included.

This retractable utility knife has premium features including a quick change blade, closed blade band cutting slot, internal blade storage, and an integrated carabiner. Kit includes 10 knives, 10 x 50 packs of tungsten carbide edge blades and a rugged ballistic nylon tool bag.

Carbide Cutter Kit			
Item No	GSA	NSN	Desc
690-PTK-01			Carbide Cutter Kit



10 Retractable Utility Knives



10 50 Packs Carbide Blades



Tungsten Carbide Edge Blades

Stapler Kit			
Item No	GSA	NSN	Desc
690-PTS-04			Staple Gun Upholstery Kit

One kit for all your industrial stapling needs. Our Heavy-Duty Stapler shoots industry standard T50 heavy duty staples. The Cable Stapler shoots T25 staples while holding cables centered. Whether you are upholstering furniture, building fixtures, or tacking down wires, this set of staplers has got you covered. Kit includes Staplers, Rugged Ballistic Nylon Tool Bag, and 5000 each T50 staples, T25 cable staples.



The Impact Driver Starter Kit gives you everything you need to tackle the most demanding jobs. The powerful 1/2" Impact Wrench with 2 batteries is accompanied by SAE and metric deep impact sockets, SAE and metric shallow impact sockets, 1/2" ratchet, adapters, tactical work gloves, and a rugged ballistic nylon tool bag.

Impact Driver			
Item No	GSA	NSN	Desc
690-PTW-04			Impact Driver Kit with SAE & Metric Sockets



7/16" to 1"
13mm to 24mm



METRIC
10mm to 36mm

SAE
3/8" to 1-1/2"



Lube It Like You Mean It! This cordless Grease Gun provides 10,000 max PSI to push through clogged grease fittings and can flow up to 5 oz. per minute. Kit comes with grease gun, 42" flexible hose, 7pc lube accessory kit, LockNLube zerk fitting coupler, tactical work gloves, battery, and charger, all packed in a rugged tool bag.

Grease Gun Kit			
Item No	GSA	NSN	Desc
690-PTG-04			Cordless Grease Gun Kit



Jobsite LED Light Kit

Let there be light! A 3000 lumen light bazooka when folded, this bad boy extends to 7ft high, runs for over 7 hours, and is IP54 rated. Kit includes 20V battery, charger, tripod light, tactical work gloves and a rugged ballistic nylon tool bag.

Jobsite LED Light Kit			
Item No	GSA	NSN	Desc
690-PTL-01			Jobsite LED Lighting Kit



Green

Red



10 Lumen



70 Lumen



300 Lumen



800 Lumen



Move Over Bacon, Now There's Something Greasier! Handheld grease guns can't deliver the volume of grease needed for heavy equipment or wheeled and tracked vehicles. This mega grease pump lets you handle the biggest jobs with ease, and you can rest those forearms because this pump is operated with a foot pedal. Includes a 50 pack of black nitrile gloves.

- Includes the LockNLube Grease Coupler, 10ft long reach hose, easy carry handle, and grease scoop
- Pressure return valve clears pressure from the hose and returns grease to the canister with no mess
- Foot pump develops 10,000 PSI of pressure
- Holds over 2 gallons of grease
- Reduce costs by using bulk grease

Grease Pump			
Item No	GSA	NSN	Desc
690-PTG-05			Giant Grease Pump



Portable Power Station			
Item No	GSA	NSN	Desc
690-PTP-01			Jobsite Portable Power Station Kit

Jobsite Charger / Power Station

Charge 20V/60V batteries 4 at a time, or use the charger as a 120V portable power station to run plug in tools or other 120V devices. Kit includes charger, 2 x 20V batteries, 2 x 60V batteries, 10ft extension cord, portable Bluetooth speaker, one pair of tactical work gloves, and a rugged ballistic nylon tool bag.



Spade Bit Not Neutered – The Spade Bit Set is so nice it will leave you looking for reasons to drill holes. The set includes 17 sizes of spade bits, ideal for cutting holes in wood, and plastic. The bits range in size from 1/4" to 1-1/2" in diameter, and each features a hex shank for use on quick change drill or driver chucks. The kit will come in handy when building a base camp, routing wires, or scuttling a wooden ship. Get your set today and you'll be a little bit holier.

Spade Bit Kit			
Item No	GSA	NSN	Desc
60661			Spade Bit Kit



Soft Drill Shroud



Bench Grinder Abraso-Vac Kit includes an 8" - 3/4 HP grinder with stand. The grinder can be bolted to a work bench or mounted on the stand. Each kit includes the bench grinder, stand, two grinding wheels, wire wheel, additional accessories, and adapters to connect to the included scorpion pneumatic HEPA vacuum for optimum dust control. **Work rests and safety shields included but not shown.**

Bench Grinder			
Item No	GSA	NSN	Desc
690-PTG-03			Bench Grinder 8in & Stand



Wire Wheel



Scorpion Pneumatic Vacuum



INCLUDES
DUST COLLECTION

Handy Vac			
Item No	GSA	NSN	Desc
690-PTV-01			Handy Vac Kit

Cordless HEPA Vac

This HEPA Vacuum traps 99.97% of dust 0.3 microns and larger. Use the vac by itself or with the included hose, wand and attachments. Kit includes vacuum, battery, charger, extension hose, wand, floor tool, dust brush, crevice tool, tactical work gloves, and a rugged ballistic nylon tool bag.



Cordless HEPA Vac

Feeling Hot Hot Hot! The cordless 20V heat gun provides up to 990 degrees of continuous heat. Kit includes heat gun, three batteries, charger, flat nozzle, hook nozzle, and a large assortment of heat shrink tubing. Everything is packed in a ballistic nylon tool bag with one pair of tactical work gloves.

Heat Gun			
Item No	GSA	NSN	Desc
690-PTH-03			Cordless Heat Gun Kit

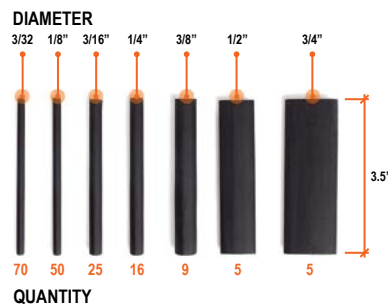

The NIOSH Approved Clayton **Respirator Hood** by PureFlo is a game changer in PPE. This innovative system protects workers from injuries to the head, face, eyes, and respiratory system, and is ideal for work in areas where chromates, heavy metals, silica, and other hazardous dust is present. The unit is completely self-contained, with no need for belt mounted blowers or hoses to encumber the user. The battery powered filter system maintains positive pressure inside the hood, providing 8 CFM of airflow to ensure that dust and debris cannot enter the breathing zone. The constant airflow also creates a cooling effect and keeps the visor free of fog. It has a wide field of view and is perfectly balanced to reduce fatigue. Unlike conventional half and full face respirator systems, the Clayton Hood does not require respirator fit checks, and it can be used with all types of facial hair.

Respirator Hood Starter Kit			
Item No	GSA	NSN	Desc
130152			Respirator Hood Starter Kit
627-R02020SP			Respirator HEPA Filters 8 PK

Kit includes:

- Respirator Hood Assembly
- 8 Pack of Replacement Filters
- 1 Storage Backpack
- Visor Protector Films
- 2 Headband Assemblies
- 2 Sets of Replacement Padding
- 1 Set of Cleaning Wipes

Features:

- Filter monitor alerts when filter is saturated
- Battery monitor alerts when power is low
- Batteries provide 7 hours of constant use
- Constant airflow prevents fogging of visor
- Airflow has significant cooling effect for user
- No need for fit checks
- Facial hair friendly – Bring your favorite moustache
- Wide field of vision
- Adjustable headband
- Electronic battery and filter monitor

Specifications:

- Head Protection ANSI Z89.1 Type 1 Class G
- Face/Eye Protection ANSI Z87.1+
- Respiratory HEPA (HE) NIOSH 42CFR84
- Flow Rate 8.1 CFM
- Noise Level <70 dBA
- Weight 4.9 lbs
- Battery Duration 7 hours
- Rating Class I, II, III, Div 2 Groups ABCDEFG

Assigned Protection Factor APF 1000



Can You Hear Me Now? Hearing protection is critical on flight decks, at the range, and in manufacturing or maintenance. These over-the-ear silencers provide 30dB of noise reduction, and are comfortable to wear. Packed in a tough cordura pouch with a secondary pocket for the included ANSI safety glasses. This is a great kit that provides key protection for most environments.

Hearing Protection			
Item No	GSA	NSN	Desc
690-PTE-01			Ears And Eyes PPE Kit



Safety Glasses



Over-The-Ear Silencers



Protect your workers from hazardous dust, flying debris, and loud noises with our **Eye, Ear & Respiratory Kit**. This kit includes the key personal protective equipment needed for working in industrial environments. Safety glasses are ANSI Z87.1 rated, ear plugs are ANSI S3.19-1974 rated, and the respirators are N95 NIOSH approved. N95 respirators protect the wearer from airborne particles and from airborne liquid droplets. The CDC, NIOSH, and OSHA regulate N95 respirators.

Eye, Ear, Respiratory Protection			
Item No	GSA	NSN	Desc
130083			Eye, Ears, and Respiratory Protection Kit



10 Safety Glasses



100 Earplugs



100 N95 Niosh Respirators



Tyvek coveralls are the defacto standard in coverall protection. They sport a comfort fit design, storm flap zipper, respirator fit hood for bad hair days, and elastic wrist/ankle/waist. Each kit includes 25 coveralls.

Coveralls			
Item No	GSA	NSN	Desc
955-PPE01-M			Protective Suit with Hood Kit Medium 25pk
955-PPE01-L			Protective Suit with Hood Kit Large 25pk
955-PPE01-XL			Protective Suit with Hood Kit XL 25pk
955-PPE01-2XL			Protective Suit with Hood Kit 2XL 25pk
955-PPE01-3XL			Protective Suit with Hood Kit 3XL 25pk



Boot Covers			
Item No	GSA	NSN	Desc
955-PPE-02			Boot Covers 200 pair - One Size Fits All

Don't be caught without the matching shoe booties. One size fits all. Each kit includes 200 pair.



Exam time! These disposable two layer nitrile gloves are so comfortable and durable that you won't want to throw them out when you're done. Each kit includes 500 gloves (250 pairs) in a dispenser-style box plus a 5-pack of garbage bags.

Nitrile Glove Kit			
Item No	GSA	NSN	Desc
955-PPE-03		8415-01-460-4037	Nitrile Glove Kit



30gal Garbage Bags



500 Nitrile Gloves

PREMIUM GLOVES

protect your hands from grease, grime, dirt, oil, fuels, nicks, scrapes and more



TWO LAYER TOUGHNESS

black outer layer and white inner layer help identify breakthrough



HEAVY DUTY NITRILE GLOVES

6 mil thickness for better rip, tear, puncture, and chemical resistance



Don't Tread on Me! Actually, go right ahead - that's what sticky mats are for. Place mats at transition spaces where you want to prevent the transfer of contaminants from one room or area to the next. Each time the top sheet is full of dust just rip it off to reveal the next. Each kit includes 1 Sticky Mat, 16 refill packs (each with 30 sheets), and a 5-pack of garbage bags. That's over 500 sheets!

Sticky Mats			
Item No	GSA	NSN	Desc
609040			Sticky Vacu-Sheet Mat with Refills



30gal Garbage Bags



Tape and Striping Kit			
Item No	GSA	NSN	Desc
19451			Vacu-Disc Masking Tape Kit

We all love a great paint job, and it starts with the right tools. Our Tape & Striping Kit includes 28 rolls of 3M 401+ Green Masking Tape to keep your paint lines crisp but peel off easy, 2 double sided squeegees, razor blades, paint stirrers and nitrile gloves.



Nitrile Gloves 50pk



Razor Blades



Paint Stirrers



2 Squeegees

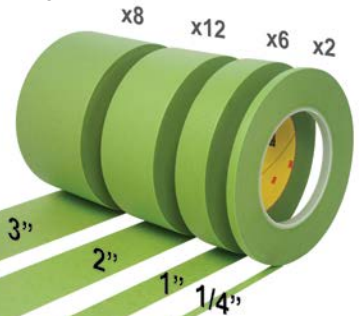

No Compressor No Problem! The ELECTRIC Random Orbital (DA) sander kit includes one 3" and one 6" Random Orbital sander, both ready for vacuum sanding. These brushless, 120V, direct plug-in, low profile sanders are smooth as silk and quiet as a sleeping mouse. Kit includes 6 boxes of screen abrasive (120, 180, 240) for each, and a rugged ballistic nylon toolbag. Pair with our Jobsite Charger / Power Station for hours of cordless sanding!

ElectroLite ROS			
Item No	GSA	NSN	Desc
870-2ROS-KIT			Electric ROS Sander Kit 3 & 6

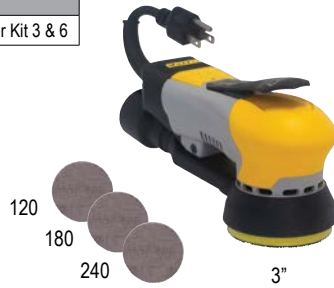

50 Each - 120, 180, 240 Grit 3" Screen Abrasive Sheets



50 Each - 120, 180, 240 Grit 6" Screen Abrasive Sheets

Compressed Air Not Required! The ELECTRIC Orbital (jitter) sander kit includes one 2-3/4x8" and one 3x4" Orbital sander, both ready for vacuum sanding. These brushless, 120V, direct plug-in, low profile sanders are smooth as silk and get into all those tight corners. Kit includes 6 boxes of screen abrasive (120, 180, 240) for each, and a rugged ballistic nylon toolbag. Pair with our Jobsite Charger / Power Station for hours of cordless sanding!

ElectroLite OS			
Item No	GSA	NSN	Desc
870-2OS-KIT			Electric OS Sander Kit 3x4 & 2x8



50 Each - 120, 180, 240 Grit 3x4" Screen Abrasive Sheets



50 Each - 120, 180, 240 Grit 2-3/4x8" Screen Abrasive Sheets

Back That Thing Up! High quality American Made backup pads are designed to fit most industrial sanders. Vinyl faced pads feature a 5- or 6-hole pattern and are used with Gold PSA abrasives. Grooved pads are also for PSA abrasives, but feature dust channels so they work great even if the holes aren't lined up. Multi-hole J-Hook pads provide the best possible dust collection, and have hooks that attach to Screen Abrasives or Clean Sanding discs.

Vinyl Backup Pads			
Item No	GSA	NSN	Desc
672-351S			3.5in - 6 Hole Vinyl
672-511S			5in - 5 Hole Vinyl

Hook & Loop Backup Pads			
Item No	GSA	NSN	Desc
672-301J			3in - 6 Hole JHook
672-351J			3.5in - 6 Hole JHook
672-501J			5in - 5 Hole JHook

Hook & Loop Multi-hole Pads			
Item No	GSA	NSN	Style
672-511J			5in - Multi Hole JHook
672-611J			6in - Multi Hole JHook

Grooved Vinyl Pads			
Item No	GSA	NSN	Style
672-511SG			5in - 5 Hole Vinyl Grooved



Vinyl Backup Pads



Hook & Loop Backup Pads

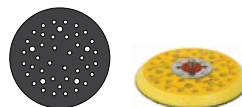

Hook & Loop Multi-Hole Pads



Grooved PSA



Low Profile Edge

Extend the life of J-hook backup pads with pad protectors. Wear down these inexpensive disposable pads instead of valuable backup pads. Loop on one side, J-Hook on the other, these pads sit between your J-Hook backup pad and your abrasive.

Pad Protectors			
Item No	GSA	NSN	Desc
672-35JP			Pad Protector 3-1/2in JHook 50 pk
672-50JP			Pad Protector 5in JHook 50 pk
672-60JP			Pad Protector 6in JHook 50 pk



3.5" Pad Protector



5" Pad Protector



6" Pad Protector



Pad Protector Sits Between the Backup Pad and the Abrasive

AeroLite Composite Body Pneumatic Sanders

AeroLite Composite Body Sanders			
Item No	GSA	NSN	Desc
675-12301J			3in DA Sander 12K rpm 3/16 orbit
670-12401J			3.5in DA Sander 12K rpm 3/16 orbit
670-12501J			5in DA Sander 12K rpm 3/16 orbit
670-12601J			6in DA Sander 12K rpm 3/16 orbit
670-10371J			3-2/3 x 7in Jitter Sander
675-10341J-KIT			3x4in & Radius Sander Kit

- Light composite housing
- Integrated dust collection
- Produces 0.28 HP



AeroLite Composite Body Pneumatic 2-Hand Sanders

Two Hand Composite Body Sanders			
Item No	GSA	NSN	Desc
676-12521J			5in 2-Hand DA Sander 12K rpm 3/8 orbit
676-12621J			6in 2-Hand DA Sander 12K rpm 3/16 orbit
676-12801J			8in 2-Hand DA Sander 12K rpm 3/16 orbit

- Light composite housing
- Integrated dust collection
- Produces 0.45 HP



DuraLite Aluminum Body Pneumatic Sanders

DuraLite Aluminum Body Sanders			
Item No	GSA	NSN	Desc
775-12601J			6in DA Sander 12K rpm 3/16 orbit
775-10281J			2-3/4 x 8in Jitter Sander

- Durable aluminum housing
- Integrated dust collection
- Produces 0.28 HP



ErgoLite Composite Body Pneumatic Sanders

ErgoLite Composite Body Sanders			
Item No	GSA	NSN	Desc
770-12501J			5in DA Sander 12K rpm 3/16 orbit
770-12601J			6in DA Sander 12K rpm 3/16 orbit

- Light composite housing
- Integrated dust collection
- Produces 0.28 HP
- Directional exhaust
- Fan blade cooling extends bearing life



Self Generated Sanders use the tool exhaust to create a vacuum, drawing sanding dust into a filter bag on the back of the sander. Each sander includes 50 bags and 1 bag adapter.

SGV Sanders & Filter Bags			
Item No	GSA	NSN	Desc
130043			5in SGV Sander / Filter Bag 50 pk
130063			6in SGV Sander / Filter Bag 50 pk
130123			SGV Filter Bag 100 pk

These bags are for nuisance dust only. They are not HEPA rated.

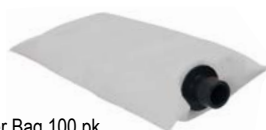

Gold Vacu-Discs feature a multipurpose aluminum oxide grain for coatings removal and finishing work. Gold abrasives have a pressure sensitive adhesive backing and holes for vacuum extraction.

3.5" Gold PSA 100 pk	
GSA	Grit
835-G080SV	80
835-G100SV	100
835-G120SV	120
835-G150SV	150
835-G180SV	180
835-G220SV	220
835-G240SV	240
835-G320SV	320
835-G400SV	400

5" Gold PSA 100 pk	
GSA	Grit
850-G080SV	80
850-G100SV	100
850-G120SV	120
850-G150SV	150
850-G180SV	180
850-G220SV	220
850-G240SV	240
850-G320SV	320
850-G400SV	400

6" Gold PSA 100 pk	
GSA	Grit
860-G080SV	80
860-G100SV	100
860-G120SV	120
860-G150SV	150
860-G180SV	180
860-G220SV	220
860-G240SV	240
860-G320SV	320
860-G400SV	400

5" Gold PSA Linkroll 100 pk	
GSA	Grit
850-GL080SV	80
850-GL100SV	100
850-GL120SV	120
850-GL150SV	150
850-GL180SV	180
850-GL220SV	220
850-GL240SV	240



3.5" - 6 Hole Gold PSA



5" - 5 Hole Gold PSA



6" - 6 Hole Gold PSA



5" - 5 Hole Gold Link Roll PSA

Screen Abrasives provide the best possible dust extraction, with no holes to line up. These aluminum oxide abrasives feature a hook and loop backing, with no adhesives to dry out or fail.

3.5" Screen Hook & Loop 100 pk	
NSN	Grit
835-P080-100	80
835-P120-100	120
835-P180-100	180
835-P240-100	240
835-P320-100	320

8" Screen Hook & Loop 50 pk	
NSN	Grit
880-P120	120
880-P180	180
880-P240	240
880-P320	320

2-3/4 x 8" Screen Hook & Loop 100pk	
NSN	Grit
808-P080-100	80
808-P120-100	120
808-P150-100	180

2-3/4 x 16" Screen Hook & Loop 250 pk	
NSN	Grit
816-DMS080HV	80
816-DMS120HV	120
816-DMS180HV	180
816-DMS240HV	240
816-DMS320HV	320

Did you know?

2-3/4 x 16" abrasive can be cut down to accommodate 2-3/4 x 8" or 2-3/4 x 5" sanders.



3.5" Screen Hook & Loop



8" Screen Hook & Loop



2-3/4 x 8" Screen Hook & Loop



2-3/4 x 16" Screen Hook & Loop



These ceramic screen abrasives have a precise grain pattern that helps them cut faster and last longer. Screen improves dust collection over 5 or 6-hole abrasives.

5" Ceramic Mesh Hook & Loop 100 pk	
NSN	Grit
850-CSA080-100	80
850-CSA100-100	100
850-CSA120-100	120
850-CSA150-100	150
850-CSA180-100	180
850-CSA220-100	220

6" Ceramic Mesh Hook & Loop 100 pk	
NSN	Grit
860-CSA080-100	80
860-CSA100-100	100
860-CSA120-100	120
860-CSA150-100	150
860-CSA180-100	180
860-CSA220-100	220



5" Mesh Hook & Loop



6" Mesh Hook & Loop

Scuff It Up! These scuff pads are made with reinforced fibers, resulting a tougher, more aggressive and longer lasting pad. They are great for surface prep before painting – the dense scratch pattern covers area more quickly than conventional pads. They are also great for polishing off corrosion or contaminants. The red pad is 360 grit, and uses aluminum oxide grain. The grey pad is 1500 grit, and uses silicon carbide. Each comes in a pack of 100.

Scuff Pads	
NSN	Grit
18558	360
18563	1500



4.5" x 9" 360 Grit

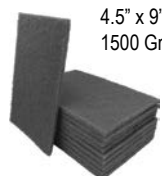

4.5" x 9" 1500 Grit

Shroud Kits include 2" or 3" dust collection shroud and abrasives. Just add any grinder with a 1/4" collet plus a vacuum and you're up and running for dustless sanding or grinding.

Shroud Kits			
Item No	GSA	NSN	Desc
690-43212KIT-TR			2in TR Clear Shroud Kit with Abrasives
690-43212KIT-TP			2in TP Clear Shroud Kit with Abrasives
690-44812KIT-TR			3in TR Clear Shroud Kit with Abrasives
690-44812KIT-TP			3in TP Clear Shroud Kit with Abrasives



TR Style



TP Style



Grinder Kits provide everything you need to be up and running for dustless sanding or grinding, just add a vacuum! Kits include 2" or 3" shrouded grinder and abrasives.

Shrouded Grinder Kits			
Item No	GSA	NSN	Desc
690-53212KIT-TR			2in TR Clear Shrouded Grinder Kit with Abrasives
690-53212KIT-TP			2in TP Clear Shrouded Grinder Kit with Abrasives
690-54812KIT-TR			3in TR Clear Shrouded Grinder Kit with Abrasives
690-54812KIT-TP			3in TP Clear Shrouded Grinder Kit with Abrasives



TR Style



TP Style



Right Angle Shrouds are designed to collect dust and debris when sanding or grinding with 2" or 3" abrasive discs. They fit any grinder with a 1/4" collet, and have a multi-hole pad to improve efficiency. The Clear Revolution shrouds are molded from clear Lexan. The Aluminum Revolution shrouds are machined from aircraft grade aluminum and anodized.

Right Angle Grinder Shrouds (no grinder)			
Item No	GSA	NSN	Desc
674-A1032TP			2in Aluminum Revolution Shroud TP Style
674-A1048TP			3in Aluminum Revolution Shroud TP Style
674-A1232TP			2in Clear Revolution Shroud TP Style
674-A1248TP			3in Clear Revolution Shroud TP Style
674-A1232TR			2in Clear Revolution Shroud TR Style



TR Style



TP Style

Right Angle Shrouded Grinders (TP Style)			
Item No	GSA	NSN	Desc
674-A1232TP-02R			2in Clear Rev TP with Dotco RT 12K .4 HP
674-A1248TP-02R			3in Clear Rev TP with Dotco RT 12K .4HP



TP Style

Postiv-Lok quick change discs provide great dust extraction when used with a shrouded grinder. The tough aluminum oxide abrasive grain makes short work of coatings and corrosion. All Postiv-Lok discs use the 6-point TP attachment method. Available in resin bond, surface-prep, and buffing discs.

2" TP Buffing Discs 100 pk	
Item No	Grit
800-32TP013V	Medium
800-32TP016V	Fine
800-32TP019V	X-Fine

3" TP Buffing Discs 100 pk	
Item No	Grit
800-48TP013V	Medium
800-48TP016V	Fine
800-48TP019V	X-Fine



TP Style

Replacement Postiv-Lok quick change disc holders or backup pads work with our TP style Postiv-Lok quick change discs and dust collection shrouds. Choose your pad based on your shroud below.

Quick Change Disc Holders			
Item No	GSA	NSN	Desc
672-1032TP-10			2in TP Style Disc Holder, No Mandrel
672-1048TP-06			3in TP Style Disc Holder, No Mandrel



TP Style



TP Disc Holder
No Mandrel



The 12,000 RPM **Belt Sander** is a must-have for your tool arsenal. This 12" x 1/2" tool can be used with or without the dust collection shroud. The powerful 0.4 hp motor powers through coatings and helps to shape and trim composites and metal. The belt arm can be rotated around the motor to accommodate different angles.



Belt Sanders			
Item No	GSA	NSN	Desc
674-A4008-02R			Belt Sander 1/2in x 12in with Shroud

Abrasive Belts			
Item No	GSA	NSN	Desc
1673120CT			ABR BELT, 1/2IN X 12, 120 GRT, 100 PK
1673080CT			ABR BELT, 1/2IN X 12, 80 GRT, 100 PK

Pneumatic Right Angle Drum Sander with vacuum extraction. Includes 2' of 1" vacuum hose and 1" swivel cuff. Use with drum or remove shroud to use as a standard right angle grinder.

Drum Sander			
Item No	GSA	NSN	Desc
690-71216-02R			Right Angle Drum Sander 1in 12K RPM

Drum Sander Abrasives	
NSN	Description
807-16D16-036	1in x 1in x 36G
807-16D16-060	1in x 1in x 60G
807-16D16-080	1in x 1in x 80G
807-16D16-120	1in x 1in x 120G
807-16D16-240	1in x 1in x 240G



Don't forget Air Tool Oil



NSN 9150-01-502-0850

Pneumatic Needle Scaler kits with vacuum extraction, 19 x 3mm and 38 x 2mm needles.

Needle Scaler			
Item No	GSA	NSN	Desc
60100			Vacu-Needle Scaler Pistol Grip Kit 19x3mm
60173			Needle Scaler Needles 19x3mm
60152H			Needle Scaler Needle Holder 19x3mm
60111S			Needle Scaler Needles 38x2mm
60113			Needle Scaler Needle Holder 38x2mm
60110			Needle Scaler Shroud
60100K			Vacu-Needle Scaler-Rebuild Kit



Pistol Grip

The most trusted grinders in the military. These tools are ergonomically designed and use the highest quality components to ensure a long service life. Available in 12,000, 20,000 and 23,000 RPM.

Pneumatic Grinders					
NSN	Grinder	RPM	HP	Mount	
690-616	Grinder Rt Angle	12K	0.4	1/4 collet	
690-611	Grinder Rt Angle	20K	0.4	1/4 collet	
674-A2048-01S	Grinder Straight	12K	0.9	1/4 collet	
604083SL	Grinder Straight	23K	0.9	1/4 collet	



Pencil Grinder Kit. Includes both straight 70K rpm and right angle 56K rpm pencil grinders, cases for each with both carbide and stone grinding burrs, clip on dust collection shrouds, Scorpion Pneumatic vac, and hoses. All packed in a rugged ballistic nylon tool bag.

Pencil Grinder Kit			
Item No	GSA	NSN	Desc
690-PGSR-01			Pencil Grinder Kit Straight/Right Angle/Scorpion



70K rpm and Right Angle 56K rpm Pen Grinders



Front Pickup



Right Pickup



Left Pickup



Straight Pickup



The most trusted grinders in the military. These tools are ergonomically designed and use the highest quality components to ensure a long service life. Straight grinders include dust collection shrouds for cutoff blades. Grinding wheels are tough and made for the most demanding metal work.

Pneumatic Grinders					
NSN	Grinder	RPM	HP	Mount	
170084	Grinder 4.5in	12K	1.7	5/8-11 spindle	
170085	Grinder 7in	8.5K	1.7	5/8-11 spindle	



Grinding Wheels					
Item No	GSA	NSN	Size	Diameter	Arbor
19449			4.5in Grinding Wheel 100pk	4.5in	5/8 Thread
152500			Flap Disc 80 grit 4-1/2in x 5/8-11 x 50pk	4.5in	5/8 Thread

The straight pneumatic router is awesome for composites, panel trimming and more. It can be used as a 1/4" collet straight grinder, a fixture router with the included router guides, and the included dust collection shroud for FOD and dust control.

Pneumatic Routers							
Item No	GSA	NSN	Description	Collet	RPM	HP	Air Inlet
60083K			Inline Router	1/4"	23,000	0.9	1/4"



- Includes
- Depth Adjustment
 - Vacuum Extraction Base
 - Vacuum Extraction Skirt



This fixed base two hand 1.7HP router has adjustable depth control and a vacuum connection.

Pneumatic Routers							
Item No	GSA	NSN	Description	Collet	RPM	HP	Air Inlet
600840			Base Mount Router	3/8"	18,000	1.7	1/2"



Diamond Pattern router bits feature an aggressive cutting edge that makes short work of honeycomb, aluminum, and composites.

Cross Cut Router Bits			
Item No	GSA	NSN	Desc
00310			3/8" Router Bit
00305			1/4" Router Bit



These saws provided all the power you need to cut through advanced composites, fiberglass, and more.

Cutoff Saws					
Item No	GSA	NSN	Description	Collet	RPM
690-A20064-116			Cutoff Saw 4in Shrouded with Diamond Blade 1/16 kerf	4in	3/4in
674-A2048-01S			Cutoff Saw 3in Alum Shrouded 12K .9hp Straight	3in	1/4in
604083SL			Cutoff Saw 3in Shrouded 23K Straight	3in	3/8in
674-A2232-01R			Cutoff Saw 2in 20K .3hp Rt Angle	2in	1/4in
674-A2032-02R			Cutoff Saw 2in Alum Shrouded 12K .4hp Rt Angle	2in	1/4in



Diamond Cutoff Blades slice easily through composite panels. The diamond cutting edge has a long life and slots in the discs help keep the discs cool.

Diamond Cutoff Blades					
Item No	GSA	NSN	Size	Diameter	Arbor
250-CW64D12			Cutoff Wheel Diamond 4in OD x 3/4in ID	4in	3/4in
250-CW64D06			Cutoff Wheel Diamond 4in OD x 3/8in ID	4in	3/8in
250-CW48D04			Cutoff Wheel Diamond 3in OD 1/4in ID	3in	1/4in
250-CW48D04S			Cutoff Wheel Diamond Slotted 3in OD x 1/4in ID	3in	1/4in
250-CW32D04			Cutoff Wheel Diamond 2in OD x 1/4in ID	2in	1/4in

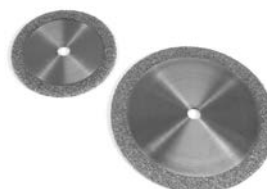

691-45-0980 Gear Lubrication

AEROLITE PRECISION DRILLS

Drilling Kits			
Item No	GSA	NSN	Desc
690-800-RK			Pneumatic Drill Kit Reversible
690-800-LSK			Pneumatic Drill Kit Low Speed
690-800-HSK			Pneumatic Drill Kit High Speed

Six of the smoothest air drills you've ever used packaged in three different kits. The reversible drills feature a lockable thumb button reverse and precision keyed chuck. The non-reversible drills are available in two kits, low speed high torque, and high speed compact. Both are equipped with precision Rohm keyless chucks for fast and easy bit changes. All drills have adjustable directional exhaust, variable speed triggers, Hogue grips, 1/4" air inlets, and each kit includes a vacuum dust collection shroud to help collect chips while drilling.



Lockable Reverse Button



Precision Keyed 3/8" Chuck



Variable Speed Trigger



Directional Exhaust



Hogue Grip



Rohm Keyless 1/4" Chuck



2000 RPM Compact Reversible



3100 RPM Compact Reversible

REVERSIBLE KIT



650 RPM High Torque



2400 RPM High Torque

LOW SPEED KIT



3200 RPM Compact



4000 RPM Compact

HIGH SPEED KIT

The Microstop Countersink Shroud Kit includes clip-on shrouds designed to fit microstops from 0.625" to 2.0" diameter. These clip-on shrouds snap directly to the microstop, providing vacuum collection for chips and dust, and allow you to use microstops already in your inventory.

Kit includes 12 shrouds, adapter hoses, and carrying case.

Microstop Shroud Kit			
Item No	GSA	NSN	Desc
1535150			Microstop Clip On Shroud Kit, 12 PC



Our Universal Drill Shroud attaches between the drill body and chuck. It will work with any non-reversing drill that has a 3/8-24 chuck. Our Soft Drill Shroud will work with ANY drill. Right angle drill is designed for heavy use. It features a 1/4-28 threaded head, runs 3300 RPM, and includes a 100 piece set of threaded cobalt aircraft bits and a dust collection shroud.

Drills & Shrouds			
Item No	GSA	NSN	Desc
674-A3005			Universal Drill Shroud (no drill)
690-73004-43			Drill Shroud & Drill 3300 rpm
674-A3122			Soft Drill Shroud 1-3/8in ID
159093			Drill Kit, Right Angle Threaded with 100 Bits and Shroud



Soft Drill Shroud



Threaded Right Angle Drill with Bits 3300 rpm

US-Made Cobalt 29-piece Jobber set in steel index, ranging from 1/16 - 1/2, in 1/64 increments.

Jobber Bit Index			
Item No	GSA	NSN	Desc
7BC-S-KIT1			29pc Drill Bit Jobber Set (1/16in - 1/2in)



US-Made Cobalt Jobber aircraft bit replenishment set. Contains 60 each #10, #21, #30, #40, and 1/4" bits.

Jobber Bit Replenishment Set			
Item No	GSA	NSN	Desc
7BC-S-KIT3			Drill Kit Jobber Cobalt 300PC



US-Made Cobalt Threaded aircraft bit replenishment set. Contains 20 each #10, #21, #30, #40, and 1/4" short bits.

Threaded Bit Replenishment Set			
Item No	GSA	NSN	Desc
8ZC-S-KIT3			Drill Kit Threaded Cobalt 100PC



US-Made Cobalt Aircraft Drilling Kits

These two kits are what fabricators and maintainers have been waiting for – everything you need for sheet metal repairs.

The Jobber Kit contains:

- 3 x 100° Zero Flute Countersink Cutters (1 each 3/32"-1/4", 1/8"-27/64", 3/16"-35/64")
- 24 x Blind Hole Spotters (6 each 1/8", 5/32", 3/16", 1/4")
- 5 x Drill Stops (1 each #10, #21, #30, #40, 1/4")
- 120 x Cobalt Drill Bits (24 each #10, #21, #30, #40, 1/4")
- 1 x Angle Drill Collet Chuck Kit
- 1 x Compartment Case



The Threaded Kit contains:

- 150 x Threaded Cobalt Bits (30 each #10, #21, #30, #40, 1/4") (short, stubby, and long lengths)
- 1 x 2" threaded drill extension
- 1 x 4" threaded drill extension
- 1 x Compartment Case

Drilling Kits			
Item No	GSA	NSN	Desc
8ZC-S-KIT1			Drill Kit Threaded Shank (Long,Short,Stubby)
7BC-S-KIT2			Drill Kit Smooth Shank with Accessories



This set includes a 1" and 2" diameter clear polycarbonate drill guides. These guides hold your drill bits perpendicular to the work surface for a straight hole every time. The vacuum attachment removes all shavings, dust, and drilling FOD. Guides are compatible with industry standard slip-fixed drill bushings (sold separately below).

Drill Guides			
Item No	GSA	NSN	Desc
674-A13XX-08SF			Clear Rev Slip Fixed Drill Guide Set (1in & 2in)



Slip Fixed Drill Bushings drop into our drill guides and lock with a quarter turn.

Drill Bushings			
Item No	GSA	NSN	Desc
721-0812SF-1935			Drill Bushing Slip Fixed #10 (.1935) 1/2in OD
721-0812SF-1590			Drill Bushing Slip Fixed #21 (.1590) 1/2in OD
721-0812SF-1285			Drill Bushing Slip Fixed #30 (.1285) 1/2in OD

Drill Bushings			
Item No	GSA	NSN	Desc
721-0812SF-0980			Drill Bushing Slip Fixed #40 (.0980) 1/2in OD
721-0812SF-2500			Drill Bushing Slip Fixed 1/4in (.2500) 1/2in OD
721-0812SF-KIT1			21pc Drill Bushing Set Slip Fixed (1/16in - 3/8in)



Air Hammers are great for loosening rusted bolts, cutting sheet metal, and breaking welds. The Clayton Air Hammer kit includes both short and long barrel, vibration damped air hammers with quick release chucks and a powerful 22mm bore. The short barrel compact hammer with a 2-1/4in stroke is rated at 3,800 blows/minute for faster more controllable cutting. The long barrel hammer is rated at 2,700 blows/minute with 3-1/2in stroke for jobs requiring more impact force. They are housed in tough protective cases with 5 assorted chisels each.

Air Hammer Kit			
Item No	GSA	NSN	Desc
690-PTH-04			Air Hammer Kit 2pc Long and Short



- 3-1/2in stroke
- 2,700 blows/minute



- 2-1/4in stroke
- 3,800 blows/minute

Warthog series HEPA vacuums are available in either air powered or electric, 5 or 15 gallon, and steel or poly tanks. All vacuums are packaged with a 20' hose and filters. (Cleanup tools are included with some kits). True HEPA filtration make these vacuums suitable for lead, asbestos, hexavalent chromium, strontium, and other toxic and hazardous dust and debris. Made in the USA from industrial quality components, these vacuums are made to last for years.

Vacs			
Item No	GSA	NSN	Desc
WH-105-0-A000			WartHog Aero HEPA Vac 5 gal 120v Poly & Hose
WH-105-4-A000			WartHog Aero HEPA Vac 5 gal Air Poly & Hose
WH-215-0-A000			WartHog Aero HEPA Vac 15 gal 120v Steel & Hose
WH-215-4-A000			WartHog Aero HEPA Vac 15G Air Steel & Hose



5-Gal Poly



15-Gal Steel



20' Hose

Supplies for Yellow Clayton Vacs			
Item No	GSA	NSN	Desc
627-0913B			Filter Bag 5gal, Poly 5 pk
600-114DM-05			Heavy Duty 30gal, Garbage Bags 5pk
627-16B			Filter Bag 15gal, Warthog 5pk
627-12H			HEPA Filter, Warthog H14
627-12P			Pre-Filter, Warthog 3pk



FOD kits include an assortment of cleanup tools specifically chosen for aircraft FOD cleanup. They feature 5 gallon poly tanks powered by air or electric.

Vac FOD Kits			
Item No	GSA	NSN	Desc
WH-105-0-A011			WartHog Aero HEPA Vac 5 gal 120v Poly & FOD Kit
WH-105-4-A011			WartHog Aero HEPA Vac 5 gal Air Poly & FOD Kit



Cleanup kit includes an assortment of cleanup tools for general use.

HEPA Cleanup Vacuum Kit			
Item No	GSA	NSN	Desc
WH-105-0-A001			Electric WartHog Vac & Cleanup Kit



One Gun Salute! The Clayton Gun Vacuum is the perfect solution for shop cleanup of non-hazardous dust, chips, and debris. The air powered hand held vacuum runs on shop air, and comes with an assortment of tips and nozzles for various applications. All the debris is collected in a durable, washable, and reusable cloth bag, or the included disposable bags. Put one in your toolbox today.

Gun Vac			
Item No	GSA	NSN	Desc
GV-100MK			Gun Vac Military Kit



Python HEPA Vacuums safely capture hazardous dust and debris and prevent exposure during bag changes. The continuous bagging system allows the material inside to be disposed of safely. Simply twist the top of the bag, and secure with two cable ties. Cut between the two ties, and continue operating the system. The design allows bag changes right on the shop floor, without special protective gear.

**CLEAN
SAFE
CONVENIENT
EFFICIENT**



Electric
212 cfm & 98in H2O

HOW IT WORKS

Step 1

Seal the bag cassette at one end with a cable tie. As the bag fills up, simply pull down to draw more material from the cassette.



Step 2

To make a new bag, pull the material down and seal it at the top with a cable tie.



Step 3

Add another cable tie above the first one and cut the bag material off between the two cable ties.



The entire process takes less than 30 seconds!

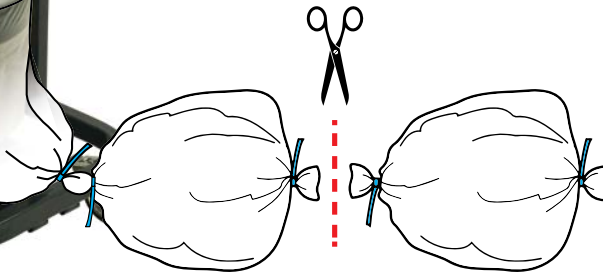

Pneumatic
168 cfm & 165in H2O

Python Vacs			
Item No	GSA	NSN	Desc
50121P			120V HEPA Vac LongoPac (212 cfm @ 98 in/H2O) Kit
20120-B			Pneumatic HEPA Vac LongoPac (168 cfm @ 165 in/H2O) Kit



Longopac



Cleanup Hose



Cleanup Kit

Each Kit Includes

- Python Vacuum
- 20ft Cleanup Hose
- Cleanup Toolkit
- Bag Refills
- 30ft 1/2in compressed airline (Pneumatic vac only)

The smallest pneumatic HEPA vac you've ever seen! The Scorpion is perfect for FOD collection in tight spaces, or vacuum sanding when portability is a must. The clear housing is made from the same clear material used in NASCAR windshields and astronaut helmets. This vacuum may be small, but it is tough, and it packs a punch!

Scorpion HEPA Vac			
Item No	GSA	NSN	Desc
SC-100MK			Scorpion Pneumatic HEPA Military Vac Kit
627-516H		4460-01-519-5158	HEPA Filter for Hornet / Scorpion
627-516P			Pre-Filter, Scorpion 5pk

- 4' x 1" Vac hose
- 4' x 1/4" Comp air line
- Assorted cleanup tools
- Prefilter 5 pack
- Extra HEPA filter



Shoulder Strap



HEPA Filter



Prefilter 5pk



Dust Brush

Gulper Tool



Crevice Tool

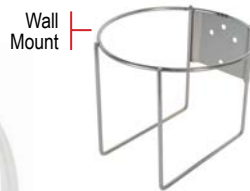

Wall Mount



Tygon FOD Wand



Tool Compressed Air Line



Flexloc FOD Wand

The Warthog HEPA **Backpack Vacuum** makes sanding and cleanup well, maybe just easy. Lightweight poly tank and padded backpack harness are ergonomic, and the powerful industrial motor makes short work of FOD and dust. 2.5 gallon filter capacity minimizes bag changes. Final stage HEPA protects against heavy metal dust exposure. The Backpack Vacuum is an excellent choice for FOD cleanup and Vacuum Sanding.

Back Pack Vac			
Item No	GSA	NSN	Desc
BP-125-0-A011			Backpack HEPA Vac 2.5 gal 120v FOD Kit



Wet / Dry kits are 15 gallon poly tanks engineered for wet or dry pickup. An assortment of cleaning tools handles any tough job.

Wet / Dry Vac Kits			
Item No	GSA	NSN	Desc
WW-115-0-A010			WartHog Wet-Dry HEPA Vac 15G 120V w Cleanup Kit
WW-115-4-A010			WartHog Wet-Dry HEPA Vac 15G Air Poly & Cleanup Kit



The **Hippo** 55 gallon drum vac kit comes complete with drum pump, hose, 55 gallon drum, and cleanup tools for liquid pickup.

The heart of the system is our stainless steel air powered flow thru drum pump which can be paired with any 5, 30, 55, or 110 gallon closed head drum to create a high powered drum vac for picking up floor spills or transferring liquids.

Our flow thru pump is reversible and has no moving parts. It can fill or empty a 55 gallon drum in less than 2 minutes. It's great for recovery of hydraulic oils, coolants, and other non-combustible fluids.

Hippo Reversible Liquid Drum Pump			
Item No	GSA	NSN	Desc
HV-1055-4-A010			Hippo Drum Vac Kit 55 gal



Belt Sanders can remove an incredible amount of material very fast. They also create lots of dust. That's why we have paired this cordless belt sander with our scorpion vacuum and dust collection attachments. Kit includes Belt Sander, 80 grit and 120 grit belts, one pair of tactical work gloves, and a ballistic nylon tool bag.

Belt Sander			
Item No	GSA	NSN	Desc
690-PTB-05			Vacu Drum/Belt Sander Starter Kit



Flexloc FOD Wand



Cleanup Hoses			
Item No	GSA	NSN	Desc
671-VHX24-10			Vacuum Cleanup Hose, 1.5in X 10ft
671-VHX24-20			Vacuum Cleanup Hose, 1.5in X 20ft
671-VHX24-30			Vacuum Cleanup Hose, 1.5in X 30ft
671-VHX24-40			Vacuum Cleanup Hose, 1.5in X 40ft
671-VHX24-50			Vacuum Cleanup Hose, 1.5in X 50ft

Cleanup Hoses are 1-1/2" crush proof conductive vacuum hose terminating in a 1-1/2" cuff and 1-1/2" metal sleeve. Combo Hoses add a compressed air line with fittings and terminate in 1" raw vacuum hose for connection to sanders and shrouded tools.

Cleanup Hoses			
Item No	GSA	NSN	Desc
671-AVHW2416-15			Air Vac Combo Hose 1.5in X 1in X 15ft
671-AVHW2416-20			Air Vac Combo Hose 1.5in X 1in X 20ft
671-AVHW2416-30			Air Vac Combo Hose 1.5in X 1in X 30ft
671-AVHW2416-50			Air Vac Combo Hose 1.5in X 1in X 50ft



Cleanup Hose



Combo Hose

Adapter Hoses			
Item No	GSA	NSN	Desc
671-VHA16-016			Adapter Hose 5ft - 1in Cuff to 1.25in Cuff
671-VHA16-017			Adapter Hose 10ft - 1in Cuff to 1.25in Cuff

Use adapter hoses to connect sander and shrouded tools to cleanup hoses.



Quick-Lok Adapter			
Item No	GSA	NSN	Desc
921-HQ2424			1-1/2in Quick-Lok Swivel Connector Cuff Assy

Quick-Lok Adapter allows the hoses above to be used with blue DCM vacuums.



Quick-Lok Adapter

Collar Ring Attachment

Vacuum Cleanup Kit			
Item No	GSA	NSN	Desc
630-A011			Cleanup Toolkit - FOD Collection

Wand, dust brush, crevice tool, gulper, and flex-loc FOD tool have a 1-1/2" OD and are designed for connection to a 1-1/2" hose cuff.



Friction Fit Attachment

Cleanup Tools - FRICTION FIT			
Item No	GSA	NSN	Desc
630-A006			Clean Up Toolkit - FOD Floor Tool & Wand
642-24F12001			FOD Floor Tool, Aluminum 1.5in x 12 (friction fit)
642-24D54101			Wand - Aluminum 2 PC 1-Bend 1.5in x 54in (friction fit)
642-24F14002			Floor Tool - Poly 1.5in x 14in Nylon Bristles (friction fit)

Floor tools are aluminum or high impact ABS. Simply press the wand in to form an airtight fit.



Collar Ring Attachment

Our heavy duty general floor tools, aluminum and high impact ABS, use a quick twist Collar Ring attachment method and have replaceable brushes.

Double Bend Wand and Floor Tools - 1-1/2" COLLAR RING				
Item No	GSA	NSN	Description	Material
642-24D56102			Wand - Aluminum 2-Bend Telescoping (collar ring)	Metal
642-24D56104			Wand - Aluminum 2 PC 2-Bend 1.5in x 56in (collar ring)	Metal
642-24F20001			Floor Tool - Poly 1.5in x 20in Nylon Bristles (collar ring)	Plastic
642-24F14103			Floor Tool - Alum 1.5in x 14in Nylon Bristles (collar ring)	Metal

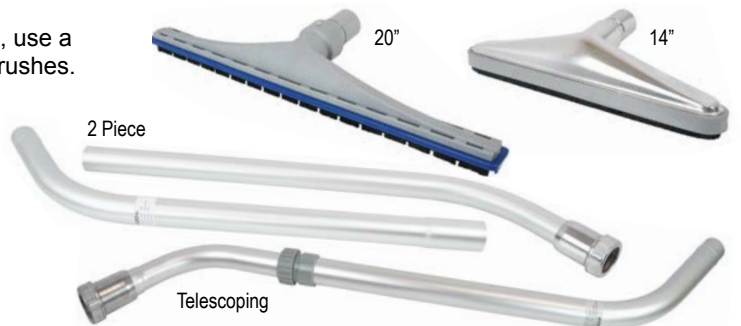

Cleanup Tools have a 1-1/2" OD and are designed for connection to a 1-1/2" hose cuff or a 1" female hose thread for 1" vacuum hose.

Clean Up Tools for Use on End of Hose - 1-1/2" Cuff				
Item No	GSA	NSN	Description	Material
642-24N09101			Rubber Nozzle - 1.5in x 9in	Rubber
500-415-1216			FOD Wand 3/4in x 1in x 18in (15 element)	Plastic
642-24R03002			3in Round Vacu-Dus Brush (1in FHT)	Plastic
642-24V11001			Crevice Tool - Poly 1.5in x 11in	Plastic
642-24V24101			Crevice Tool - Alum 1.5in x 24in	Metal
642-24G18101			Bulk Pickup Tool - 1.5 x 18 Aluminum	Metal
642-24G05002			Personnel Cleanup Brush	Plastic



Shred It and Forget It! The Powershred cross cut shredder will handle 18 sheets of paper per pass. It cross cuts to a Security Level P-4, and handles staples, credit cards, paper clips, and even that CD of George Michael's Greatest Hits that you don't want anyone to find out you still own. The unit features a 9-gallon bin and comes with a plastic liner, a large supply of extra bags, and a surge protected power strip.

Shredder			
Item No	GSA	NSN	Desc
60654			Shredder Kit with Power strip



Get hooked on our giant hose holder! Keep your vacuum hoses, compressed airlines, power cords, and water hoses off the floor and organized with our large stainless steel wall mount hose holder.

Big Hook			
Item No	GSA	NSN	Desc
650-008-KIT			Hose Holder Kit

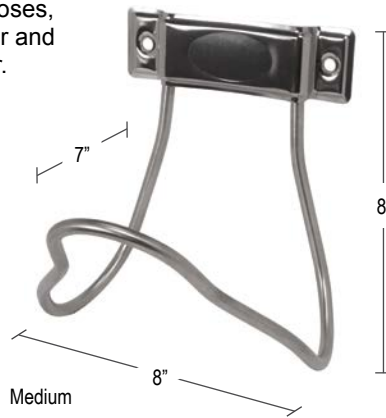

This Little Piggy is ASME certified and holds 15 gallons of compressed air. The Air Pig is the ideal way to provide compressed air to multiple tools and users. It measures 24" x 12", supports 6 users and comes ready to go with 3 1/2" couplers, 3 1/4" couplers, a 3/4" inlet, 6 brass safety ball valves, and a pressure gauge.



Air Pig			
Item No	GSA	NSN	Desc
PIG-A12X6-K1			Air Pig Military Kit

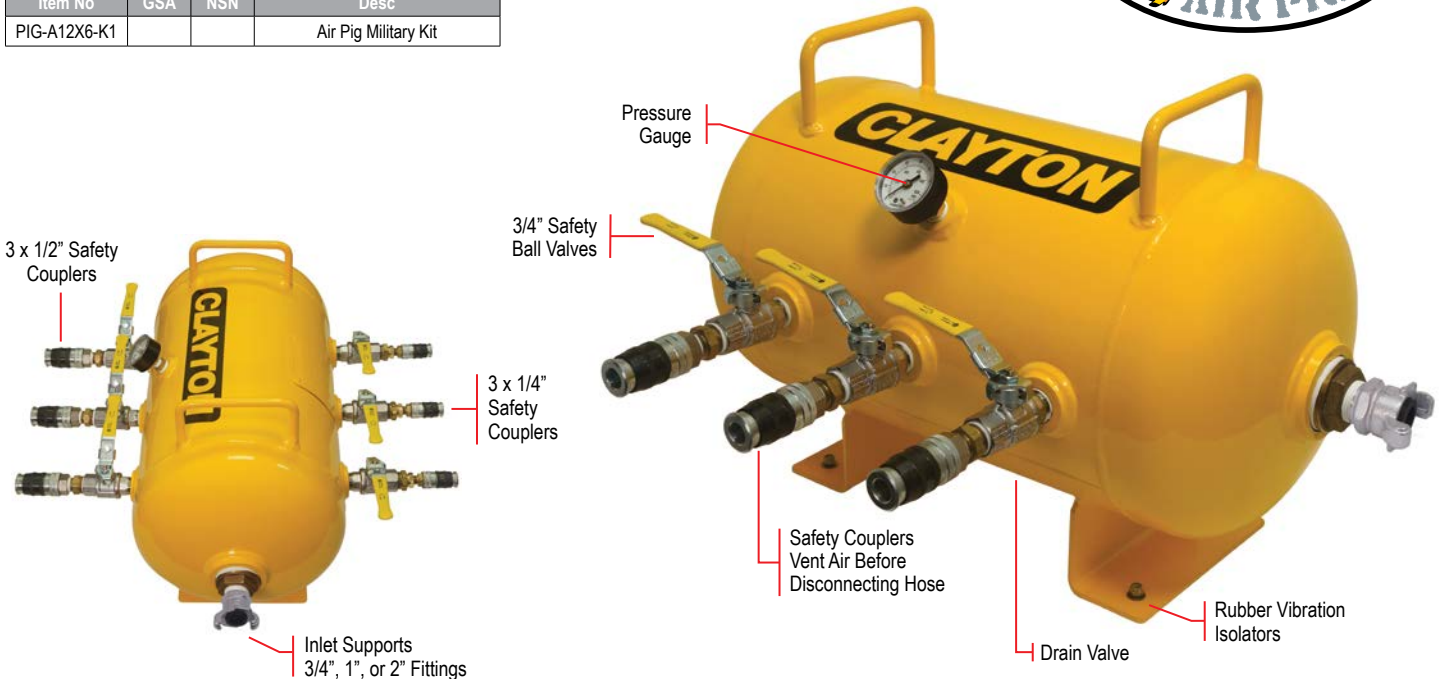

Water Not Included. Titanium coated forged aluminum fittings and PolyFusion technology make this 500psi garden hose light and flexible without kinking and the 5" swivel grip makes attaching and removing this hose without tools a snap even in cold weather. Includes 50' x 5/8" hose, adjustable spray nozzle, inline valve, and easy-carry storage strap.

Garden Hose			
Item No	GSA	NSN	Desc
00472			Garden Hose, 50 Feet



Inline Valve



Adjustable Spray Nozzle



Easy-Carry Storage Strap



500psi Garden Hose

PET Braided Sleeving is an expandable mesh tube that can be used for many applications. Use it to bundle wiring harnesses, protect hose or tubing, or to add higher visibility to cords or cables. The sleeving can be cut with scissors, or with a hot knife to seal the ends. Two sizes of sleeving fit most needs. Cold Shrink Tubing provides you with a pre-expanded rubber sleeve that contracts down when the internal spiral ribbing is removed. Use it to hold the braided sleeving on wiring bundles, or use it as a heavy duty grip on tools.

Cold Shrink			
Item No	GSA	NSN	Desc
00473			Cold Shrink for 2.625in hose (6pk) (1.125in - 2.5in ID)
00430			Cold Shrink for 3.25in hose (6pk) (1.5in - 3in ID)



Hammer not included



Cold Shrink

Mesh			
Item No	GSA	NSN	Desc
945-P24YL-50			Braided Mesh 1.5in Neon Yellow 50ft (1in -2in ID)
945-P28YL-50			Braided Mesh 1.75in Neon Yellow 50ft (1.125in - 2.75in ID)

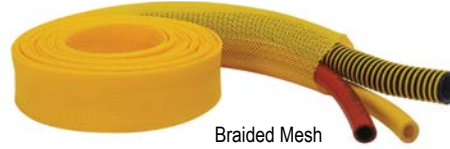

Braided Mesh

The **Vacu-Pad Grypmat** is an essential tool for aircraft and vehicle maintenance artisans. This high-performance, flexible, non-magnetic, non-slip, chemical resistant, anti-static, rubber tool mat will stay put on curved surfaces, steep angles, and rough work areas like engines. Eliminate FOD and maintain tool control while on the job. Kit includes 2 large mats in a ballistic nylon tool bag.

Tool Mat Kit (Sm, Med, Lg)			
Item No	GSA	NSN	Desc
955-TM001-K1			Tool Mat & Tactical Bag Kit



Grounding Cable includes 30' coated wire, mil-spec clamp and plug. Vacuum gauge checks water lift to ensure that your vacuum is running at its optimal level.

Diagnostic Tools			
Item No	GSA	NSN	Desc
900-A001-30		6150-01-671-8172	Aircraft Grounding Wire & Plug 30 ft
00513			Extech Water Lift Gauge/Manometer



Grounding Cable



Manometer

Make sure your air lines come to fitting end.

Fittings			
Item No	GSA	NSN	Desc
940-011			Fitting Coupler 1/4in HiFlow x 1/4 MNPT
940-08CF-PS			Coupler 1/2in FNPT Parker Safety
940-08PF			Plug 1/2in FNPT



Choose you level of compressed air conditioning. Regulator, filter, filter regulator, or filter regulator lubricator.

Compressed Air Conditioning			
Item No	GSA	NSN	Desc
926-A75F			Compressed Air Filter, 3/4 in
926-A75FR			Filter Regulator 3/4 in
926-A75FRL			Filter Regulator Oiler Lubricator 3/4in FNPT



Air lines terminate in a 1/2" Parker industrial interchange safety coupler and plug which is threaded on for easy removal if needed. Safety Coupler bleeds downstream air before unlocking from plug.

Compressed Air Hoses			
Item No	GSA	NSN	Desc
922-A08H30			Compressed Air Hose 30ft x 1/2in Steel Fittings
922-A08H50			Compressed Air Hose 50ft x 1/2in Steel Fittings
00475			Compressed Air Hose 50ft x 3/8in Steel Fittings



Blow It Up!!

Great for nail guns, blow guns, rivet guns, and tire inflators. This 1.5 cfm 2.5gal 60V lithium ion powered cordless compressor kit includes a 125 PSI regulator, a 4 port manifold, a 25ft x 3/8" compressed air line, blow gun, tire chuck, and an assortment of fittings. This is a must-have kit for field repairs and maintenance, or when your mission takes you away from the shop.

Compressor Kit			
Item No	GSA	NSN	Desc
690-PTC-01			Compressor Kit



J-B Weld Kit			
Item No	GSA	NSN	Desc
FF-RPK01			J-B Weld Kit



When fixing it is the only option! This kit contains an assortment of repair wraps for onsite fixes. Just dip the rolls of resin soaked fiber in water, then wrap around broken tools, tent poles, or anything in need of repair. Ten minutes later, it will dry hard as steel. Always be prepared! Use Repair Wrap for general purpose fixes (tools, pipes, etc.) Use Heat Wrap for high temperature fixes like exhaust pipes.



Kit Includes:

- 1 – JB Weld Plastic Bonder Epoxy
- 2 – JB Weld Exhaust Wrap
- 2 – 2" Pipe Repair Wrap
- 2 – 2" Permanent Repair Wrap
- 1 – JB Weld RTV Sealant
- 1 – SuperWeld Extreme Glue (0.53 oz)
- 1 – 2-part Epoxy (2x 5 oz tubes)
- 1 – Tactical Shears
- 1 – Gear Bag

If you're working with toxic heavy metals like HexChrome, Nickel, Mercury, Lead, Cadmium or Zinc then you need **Hexoff**. It is specifically designed to remove toxic heavy metals from the skin and other surfaces.

HexOff Decontamination System			
Item No	GSA	NSN	Desc
415-NR045			Hexoff No Rinse Wipes 45 Count
415-NR500			Hexoff No Rinse Wipes 500 Count
415-NR500RF			Hexoff No Rinse Wipes 500 Count Refill
415-DS07			Hexoff Decon Station (No Wipes)
415-SC01Q			Hexoff Surface Cleaner Spray 1qt



ChromeKiller™ neutralizes and removes Hexavalent Chromium, Cr(VI). Developed to suit the needs of the USAF, it removes Cr(VI) and converts it to non-toxic Trivalent Chromium Cr(III). It can be blended into other cleaners for use on aircraft and components.

HexChecks™ are a fast test method for determining the presence of Cr(VI).

HexChecks change color in the presence of Cr(VI). From white, to pink, to purple, the darker the color, the higher the concentration. Each Kit includes 30 HexChecks, 1 gallon bottle of ChromeKiller concentrate, and 2 empty spray bottles.

Chrome Killer			
Item No	GSA	NSN	Desc
130094			Chrome Killer Starter Kit



Field Wipes Kit removes lead and heavy metals from the skin. Ideal after shooting, training, qualifying, or when cleaning weapons. Kit includes (300) 8 x 12 wipes, (4) 15 x 25 scrub, (4) bottles of no rinse foaming hand wash, packed in a tough gear bag with flashlight.

Field Wipes			
Item No	GSA	NSN	Desc
150084			Field Wipes Decontamination Kit



Can You Handle This? Material handling carts and trucks make work easier. These handy tools of the trade are durable and designed to simplify parts handling, janitorial, and heavy lifting tasks. Add a few to your shop and take the easy way out!

Material Handling			
Item No	GSA	NSN	Desc
955-TB009		3920-01-519-5805	Material Handling Cart Grey
955-tb005			Mobile Storage Cart (black)



Mobile Utility Cart



Mobile Storage Cart

Clean Up Your Act! Our shop supplies will help keep your shop and your equipment clean after the day is done. Tough Wipes handle industrial spills and greasy cleanup. Reusable sponges and cloths are reinforced to stand up to heavy use and abuse. They can absorb water and grease, and still stay strong. Wiping sheets measure 8" x 17" and are packed 2 rolls per box. Each roll has 400 sheets. Sponges measure 4.5 x 3" and are packed 100 per box. The wipes and the sponges each include a 5-pack of industrial garbage bags. The bags are also available on their own in 5- and 25-pack quantities. Four-packs of plungers will help your shop avoid those embarrassing clogs after the all-you-can-eat buffet lunch.

Janitorial			
Item No	GSA	NSN	Desc
600-114DM-05			Heavy Duty 30gal Garbage Bags 5pk
600-114DM			HeavyDuty 30gal Garb Bags 25pk-HS Poly
955-TB005-4			Plunger 4pk
609320			Industrial Wipes, 2 Rolls
200324			Sponge Kit, 100 Pack



Industrial Wipes
100 Sheets (2 Roles)



Sponge Kit 100pk



Plungers 4pk



Heavy Duty 30gal
Garbage Bags

LongoPac Continuous Bagging Solution

This system has been engineered for the safe containment of hazardous material and general refuse. The stand includes a single cartridge, and the refill includes an additional 5 cartridges. Simply install the cartridge in the stand, and you'll have continuous bagging to safely contain hazmat or general debris.

Longo Pac			
Item No	GSA	NSN	Desc
955-LS001			Longopac Stand, Dispenser with One Cartridge
955-LP001			Longopac Maxi Bag Refill, 5 Cartridge Pack

**CLEAN
SAFE
CONVENIENT
EFFICIENT**

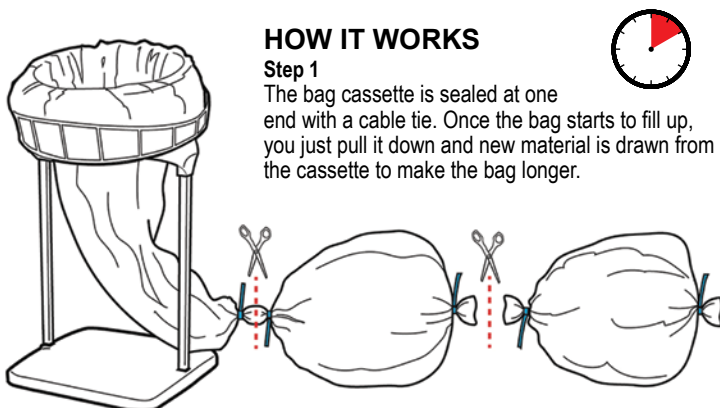

HOW IT WORKS

Step 1

The bag cassette is sealed at one end with a cable tie. Once the bag starts to fill up, you just pull it down and new material is drawn from the cassette to make the bag longer.



Step 2

To make a new bag, pull the material down and seal it at the top with a cable tie.



Step 3

Add another cable tie above the first one and cut the bag material off between the two cable ties. The entire process takes less than 30 seconds!



Captain Hook and Sergeant Loop - This box of hook and loop fastening strips is great for just about every application. Each box contains 25 yards of hook and 25 yards of loop material, 1" wide with a peel and stick backing.



Dispenser Box

Velcro			
Item No	GSA	NSN	Desc
930-159-K			Velcro Sticky Back 1in x 75ft Military Kit

Don't Leave Me Hanging! Our Carabiner set won't leave you hanging, because they're NOT made for climbing. Use them to secure light cargo or gear. Each kit contains 20 polymer carabiners and 10 write-on name tags to identify luggage or gear.

Carabiner Kit			
Item No	GSA	NSN	Desc
00425			Carabiner / Name Tag Kit



20 Gear Carabiners



2 Sharpie & 10 Gear Name Tags



Like a Jet Turbine! This variable speed fan cranks out 650cfm of air for 4-1/2 hours on a single charge. Floor, wall, or hang mount this IP54 rated fan. Kit comes with 1 x 5Ah battery (5 hours of runtime), charger, 11 inch fan, and one pair of tactical work glove.

Turbine Fan Kit			
Item No	GSA	NSN	Desc
690-PTF-01			Turbine Fan 11in Kit



Grinding Wheels			
Item No	GSA	NSN	Size
19449			4.5in Grinding Wheel 100pk
152500			Flap Disc 80 grit 4-1/2in x 5/8-11 x 50pk

Grind It Out! Our grinding wheels and flap wheels are the best in the market for metal work and material removal. All discs are 4-1/2" diameter and have a 5/8-11 threaded center hole, so they screw right onto your grinder. Use them for trimming panels, taking down welds, or carving sculptures out of old wood stumps. Stock up on these and get your jobs completed faster than ever.



Holders			
Item No	GSA	NSN	Desc
690-HTH-01			Vacu-Disc Holders and Cutters

Hold and cut Discs or anything else with our PosiVac Disc Holders. Kit includes Channel Locks, Linemans Pliers, Edge Cutters, Needle Nose, Dykes, and Side Snips in a ballistic nylon tool roll, and one pair of tactical work gloves.



Snips			
Item No	GSA	NSN	Desc
690-HTC-01			Cutter Bundle Complete Aviation Snips

This Cutter Bundle kit for cutting thin sheet metal includes Left, Right, and Center Aviation Snips in a ballistic nylon tool roll, and one pair of tactical work gloves.





**MILITARY NSN's
FOR EVERY PART OF THE JOB**



Clayton Associates, Inc.
1650 Oak St. • Lakewood, NJ 08701
P. 732.363.2100 • F. 732.364.6084
800.248.8650 • Sales@JClayton.com

2026 CATALOG
www.DustlessMadeSimple.com
www.VacuumSanding.com